



CREATOR™



31144





Get excited about our new packaging!

We're switching from plastic to paper-based packaging. That's why you might find a mix of paper and plastic in our boxes!

Nos nouveaux emballages vous emballeront !

Nous passons des emballages en plastique aux emballages à base de papier. C'est pourquoi vous pourriez trouver un mélange de papier et de plastique dans nos boîtes !

¡Te presentamos nuestros nuevos empaques!

Estamos sustituyendo las bolsas de plástico por bolsas con base de papel. ¡Por eso, puedes encontrar una mezcla de papel y de plástico en nuestras cajas!

[LEGO.com/sustainable-packaging](https://www.lego.com/sustainable-packaging)



BUILDER



Apple and the Apple logo are trademarks of Apple Inc., registered in the U.S. and other countries and regions. App Store is a service mark of Apple Inc. Google Play and the Google Play logo are trademarks of Google LLC. Tencent and the Tencent logo are trademarks of Tencent Inc.

Q [LEGO.com/devicecheck](https://www.lego.com/devicecheck)

EN Ask parents' permission before going online | **DE** Eltern um Erlaubnis bitten, bevor du online gehst | **FR** Demande l'autorisation d'un parent avant d'aller en ligne | **IT** Chiedi il permesso ai tuoi genitori prima di andare online | **ES** Pídeles permiso a tus papás antes de conectarte a Internet | **PT** Peça autorização aos pais antes de acederes online | **ZH** 上网前应先征得父母的同意 | **PL** Poproś rodziców o zgodę, zanim wejdziesz do Internetu | **CS** Než půjdeš na internet, požádej rodiče o svolení | **SK** Skôr než pôjdeš na internet, vypýtaj si povolenie od rodičov | **HU** Kérj szülői engedélyt, mielőtt online csatlakoznál! | **RO** Cere permisiunea părinților înainte de a te conecta online | **BG** Поискайте разрешение от родител, преди да влезете онлайн | **LV** Pirms došanās tiešsaistē palūdz atļauju vecākiem | **ET** Enne Interneti kasutamist küsi vanematelt luba | **LT** Prieš prisijungdami prie interneto, atsiklauskite tėvų

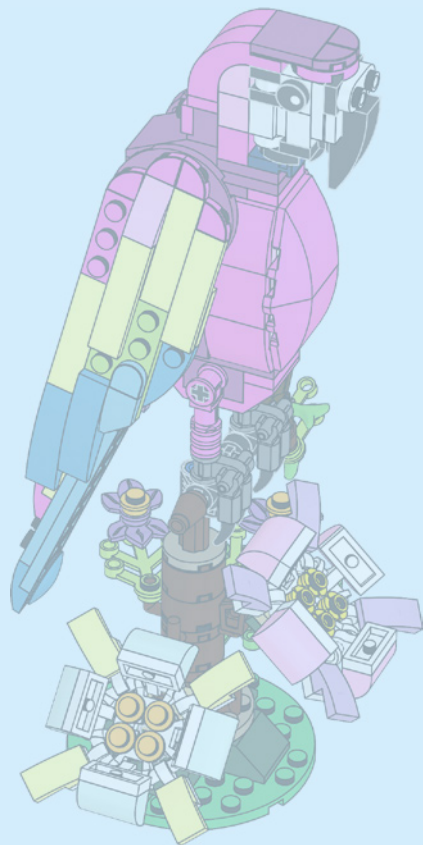

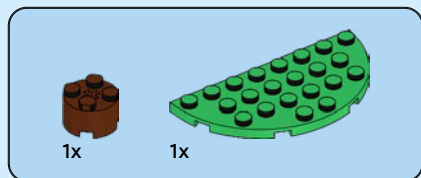

1

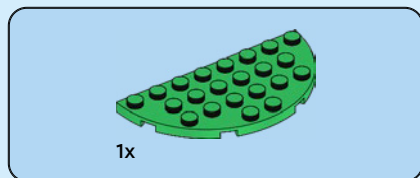
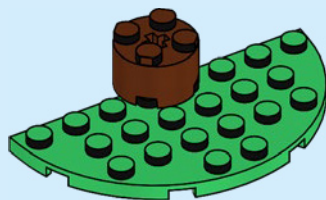

2

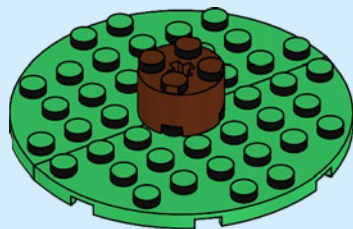



4x

3

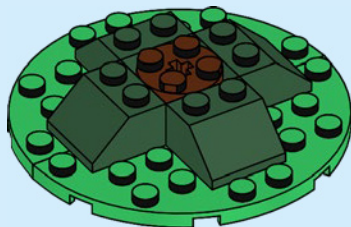

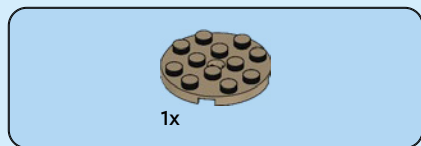

4

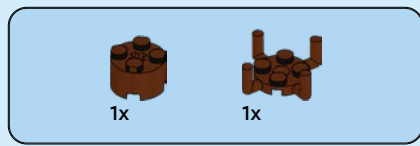
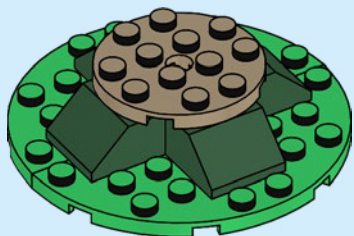

5

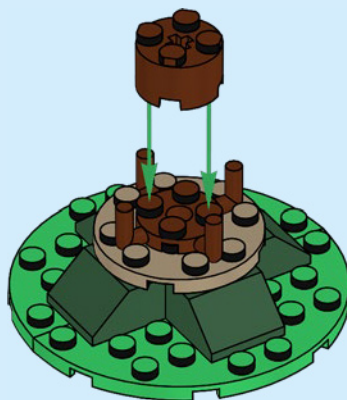

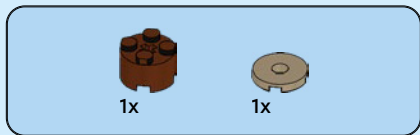
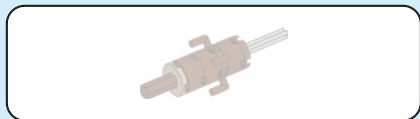

6

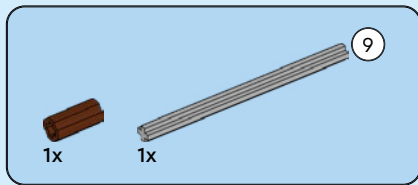
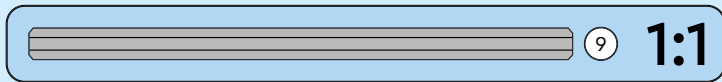
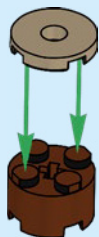

7

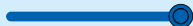
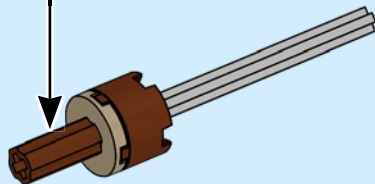
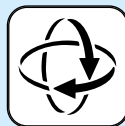
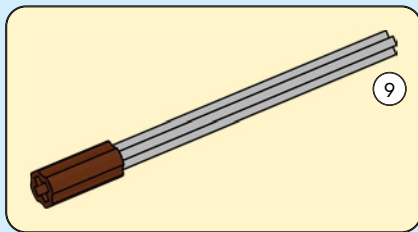

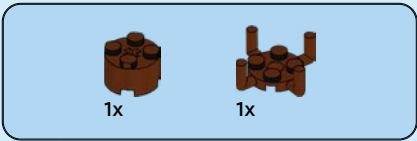

8

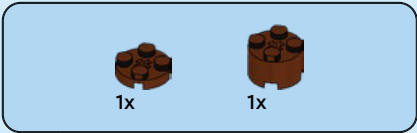
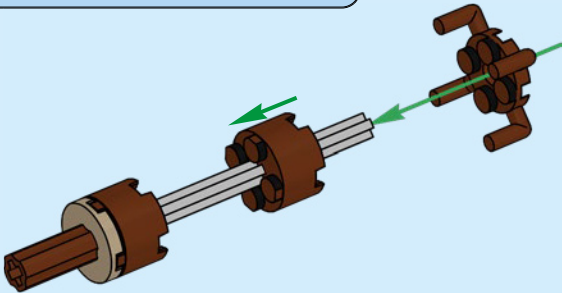

9

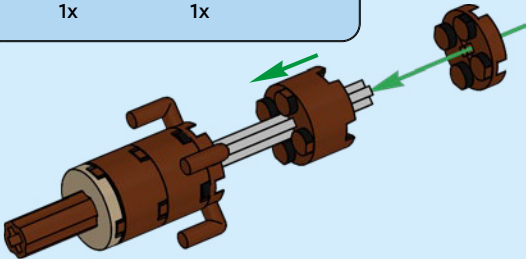

10

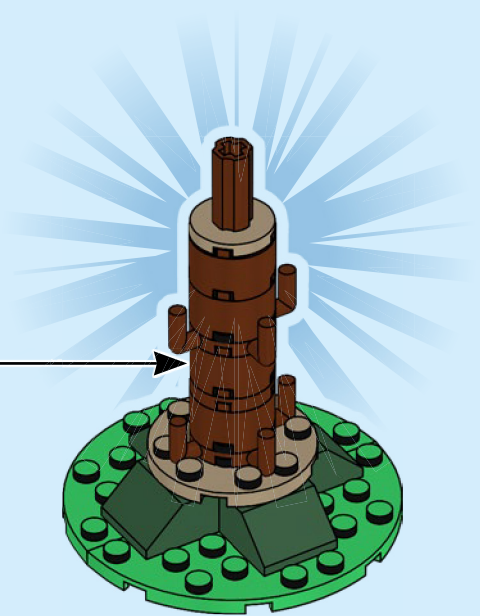

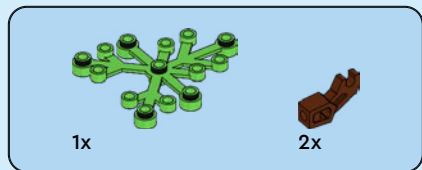

11

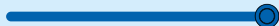
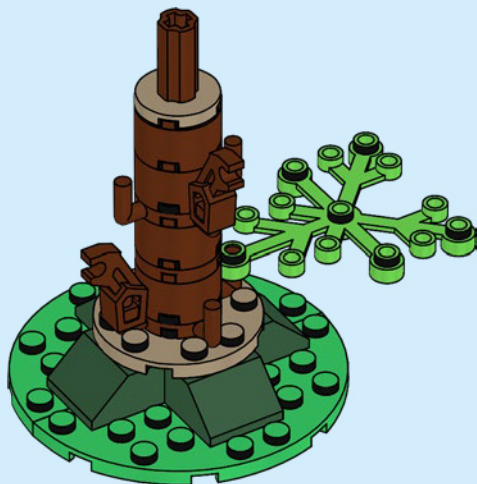



1x

12

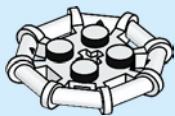

4x

13





4x



4x

14

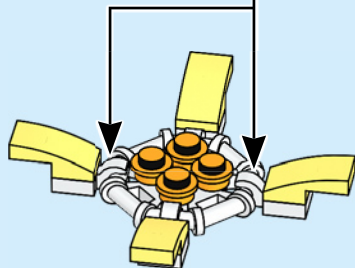
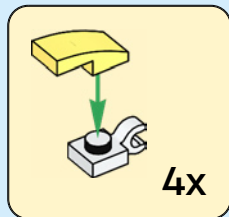

4x



4x

15

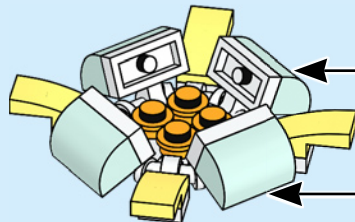
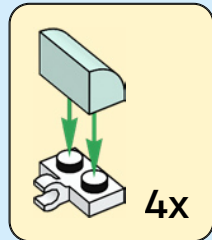

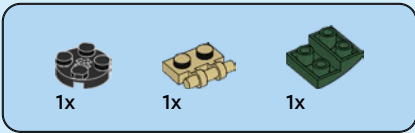

16

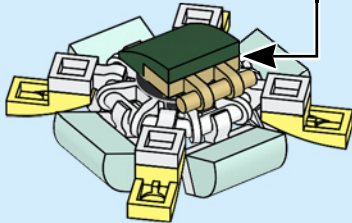
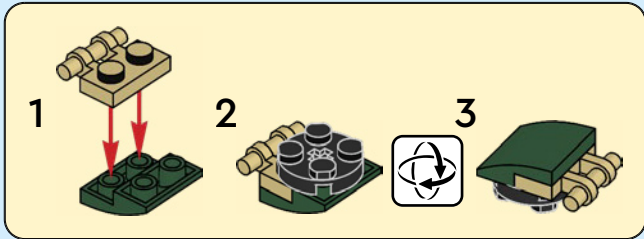

17

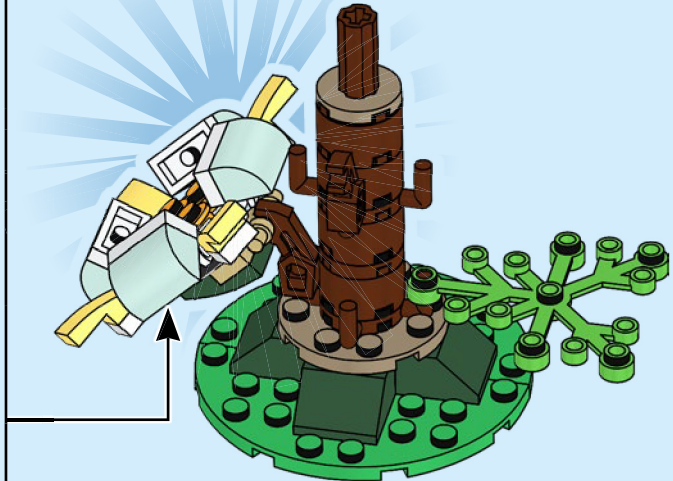



1x

18



4x

19





20

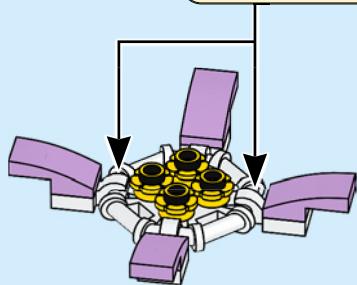
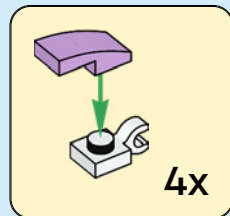

21

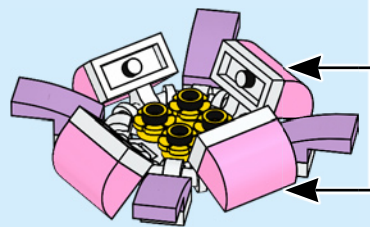
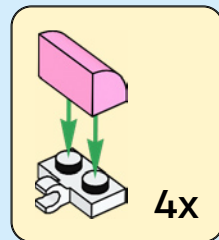

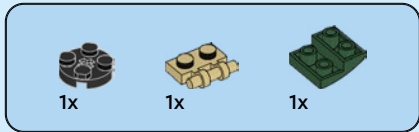

22

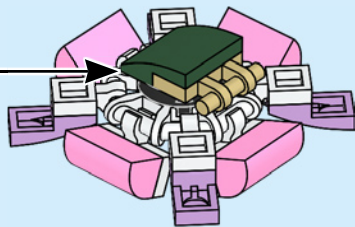
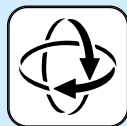
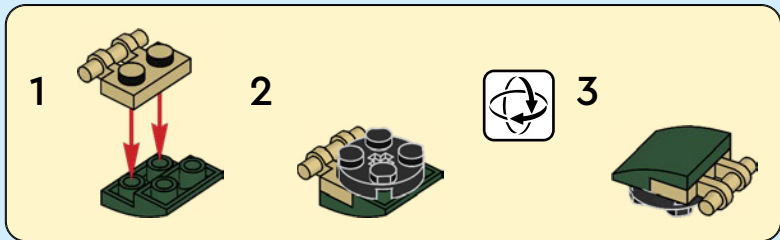

23

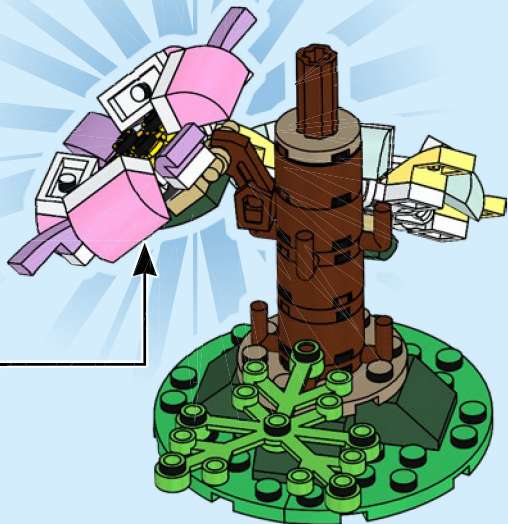



2x



4x



2x



2x

24

1



2

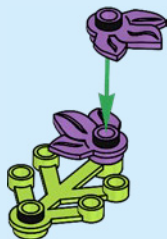

3



2x



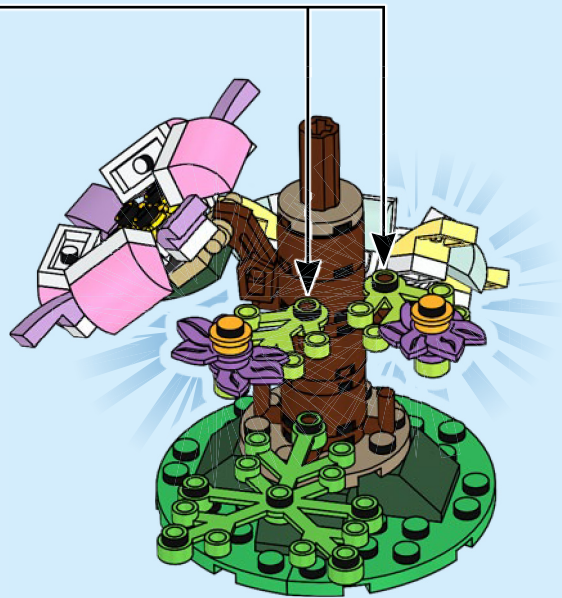



1x



1x

25





2x

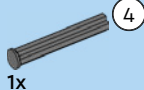

26

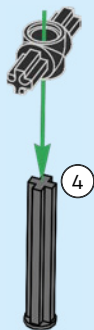

1:1



1x

27

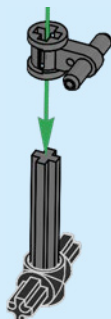



2x

28

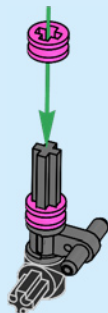

2x

29

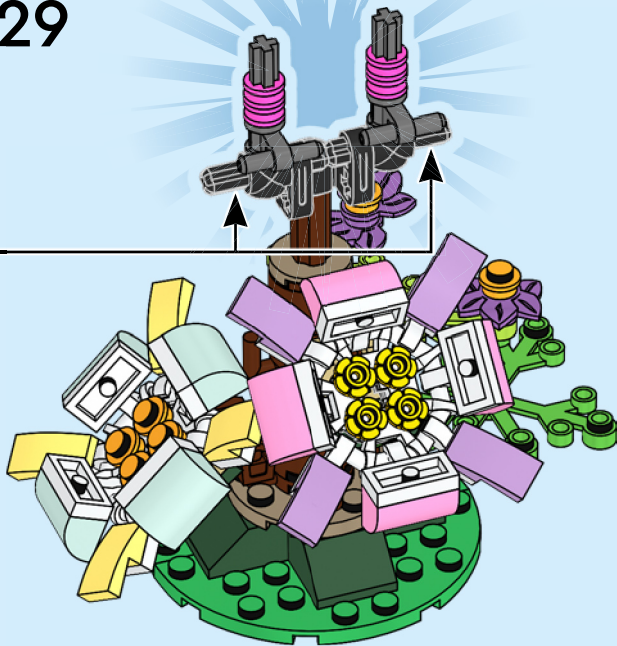



30

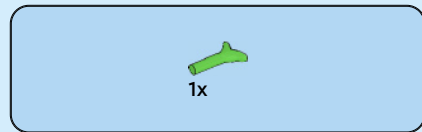

31

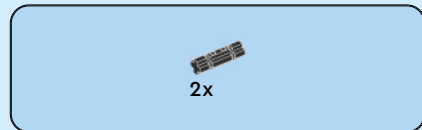

32

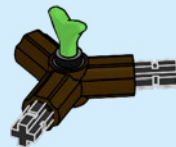



2x

33



2x

34

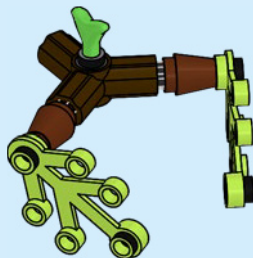



2x

35

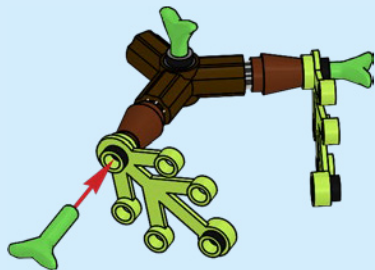

36

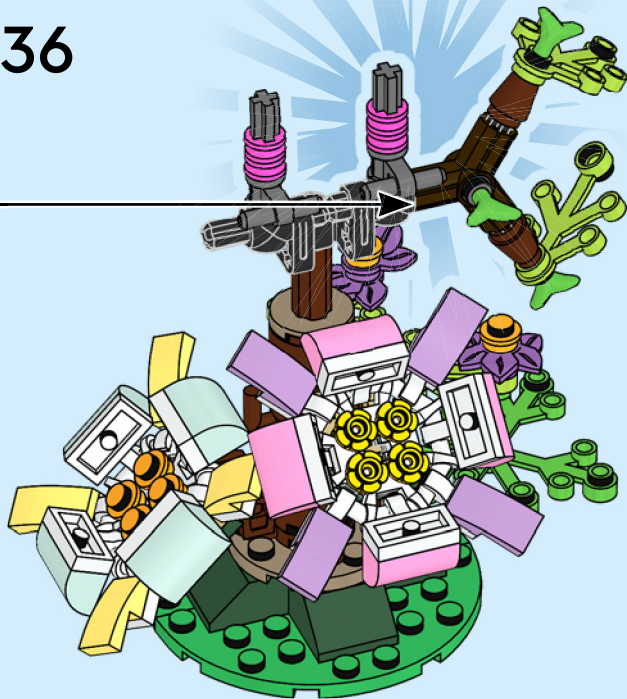



37



4x

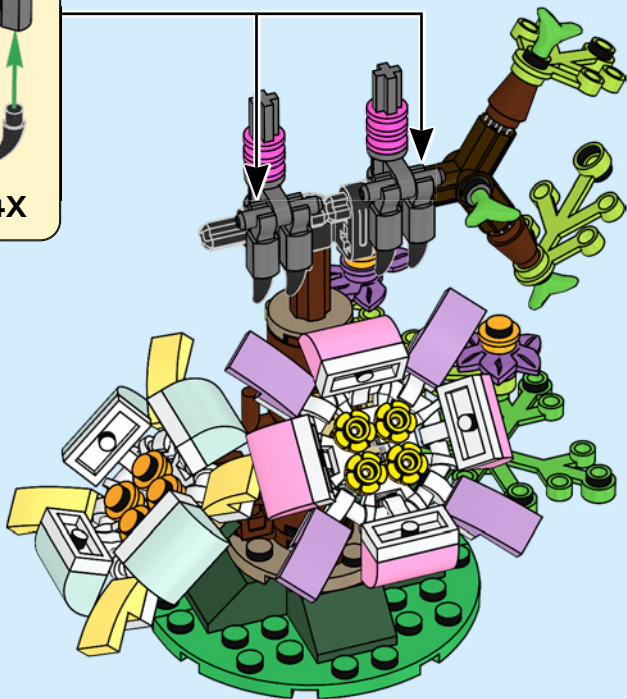



1x

38

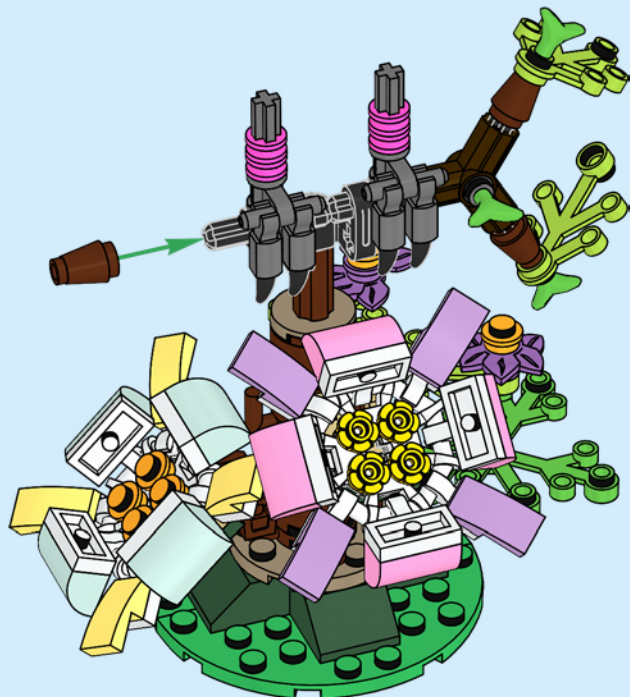

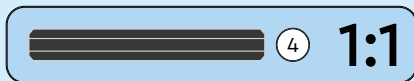
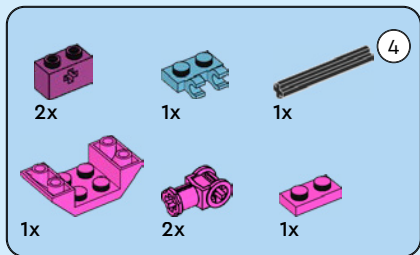

39

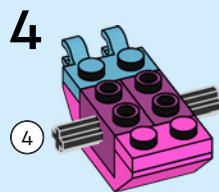
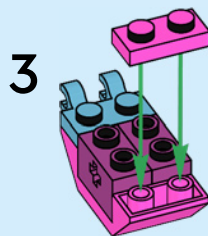
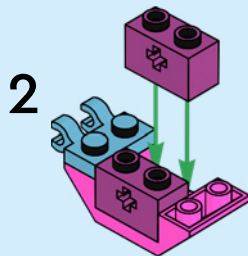
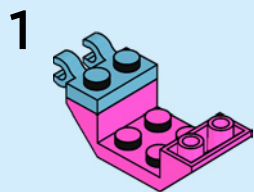

5

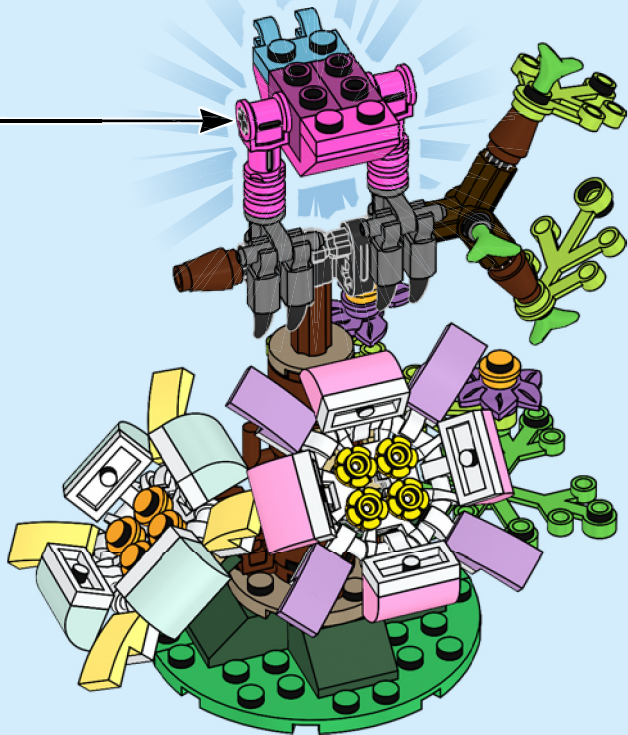
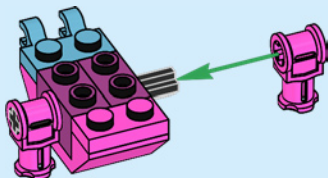

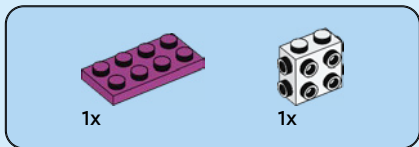
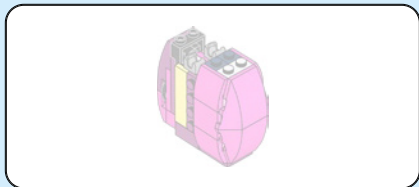

40

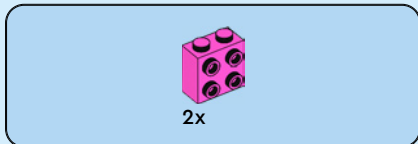
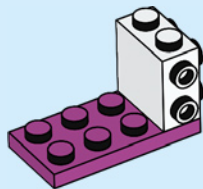

41

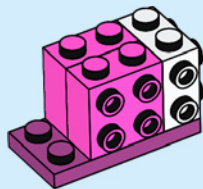



1x

42

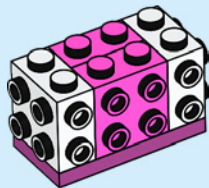

1x



1x

43

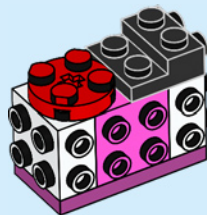



2x

44

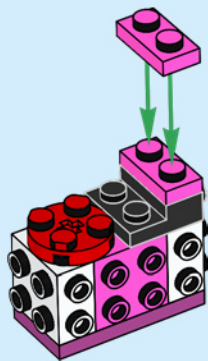

1x



1x

45

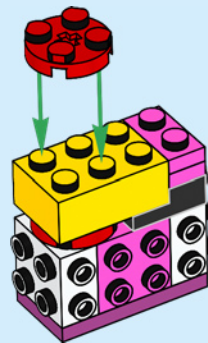

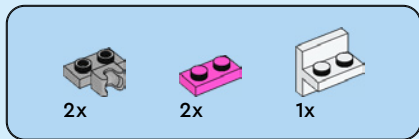

46

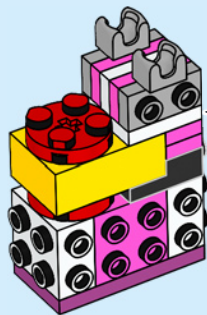
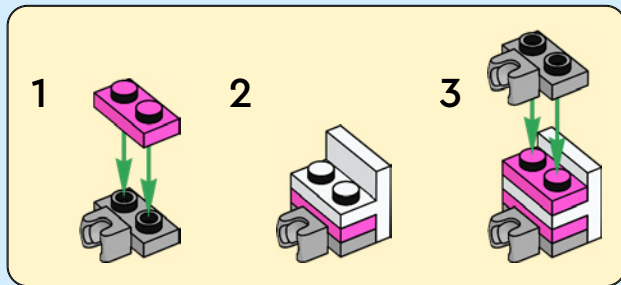

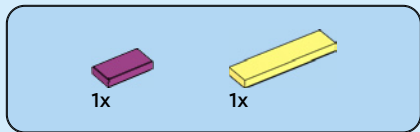

47

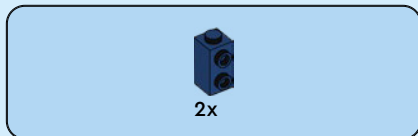
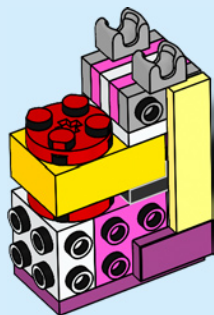

48

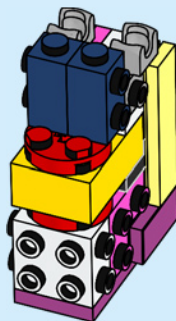



1x

49

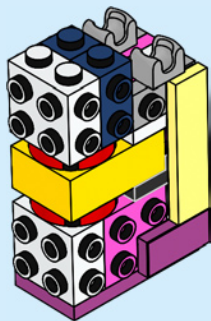

1x



1x

50

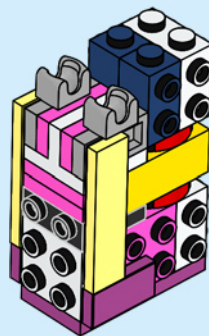



1x

51

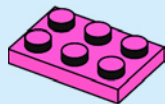

1x

52

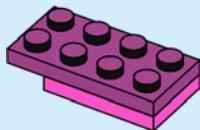

1x

53

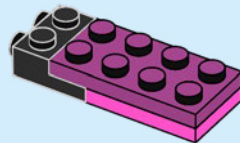



1x

54

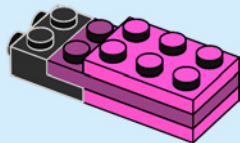

1x



1x

55



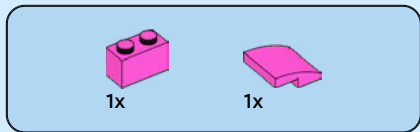

56

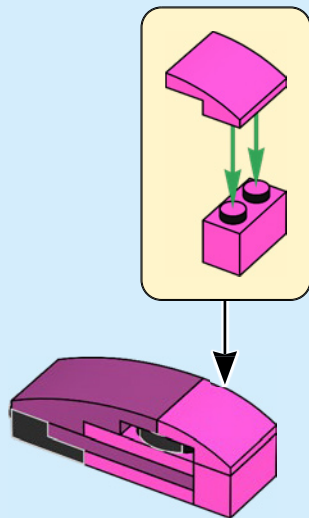

57

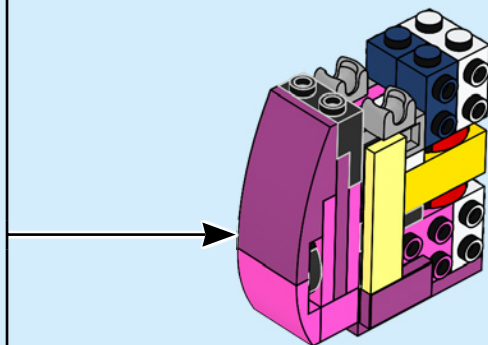

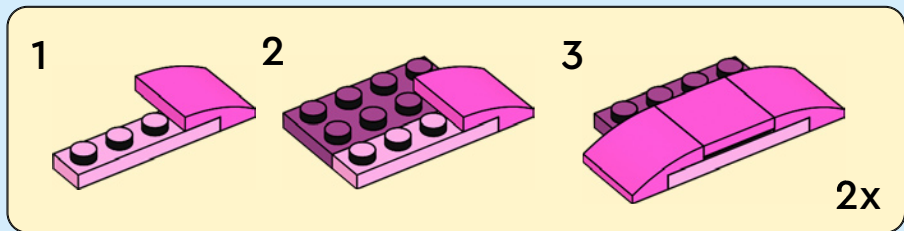
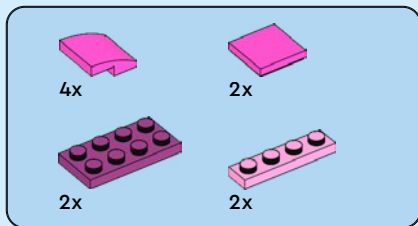

58

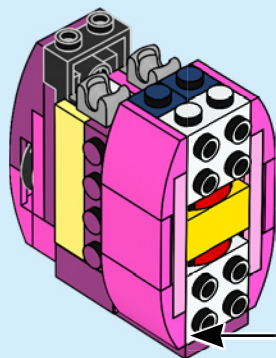

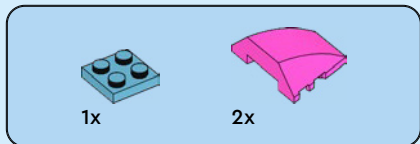

59

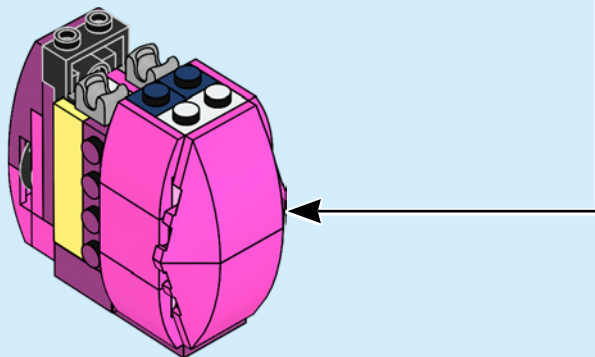
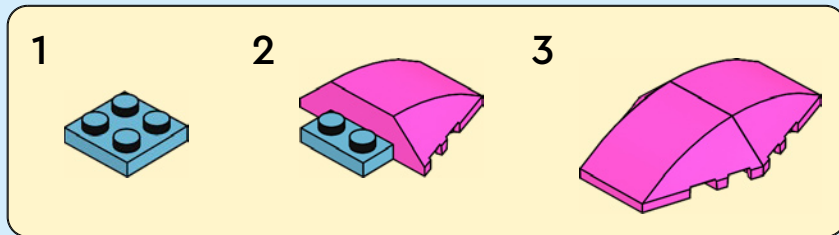

60

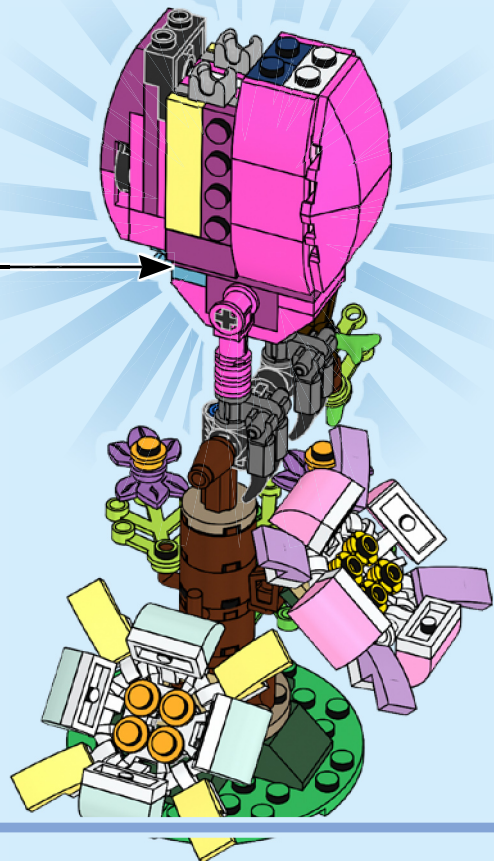

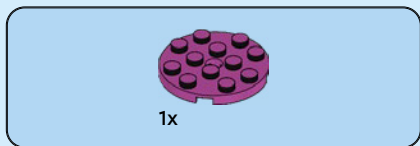
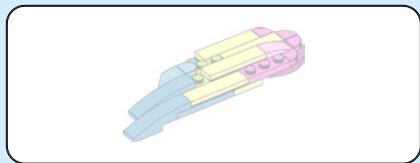

61

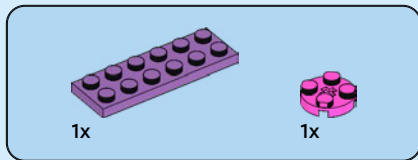

62

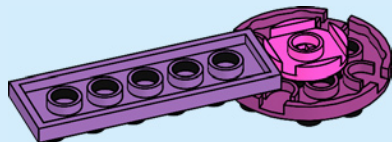

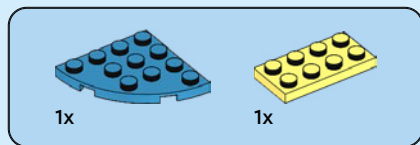

63

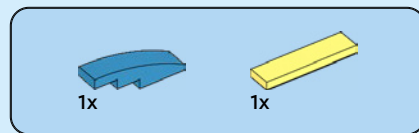
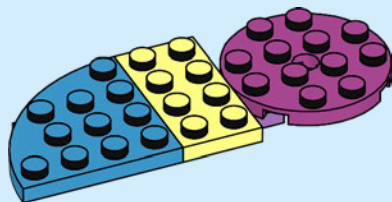

64

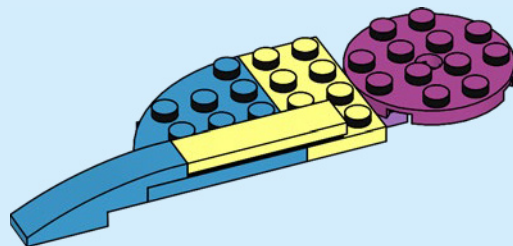

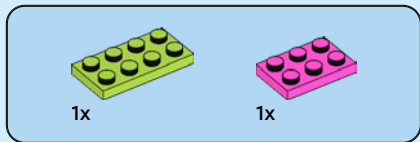

65

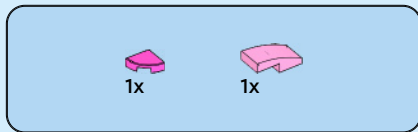
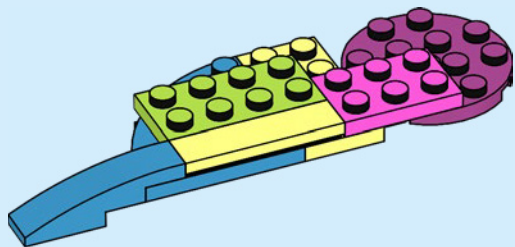

66

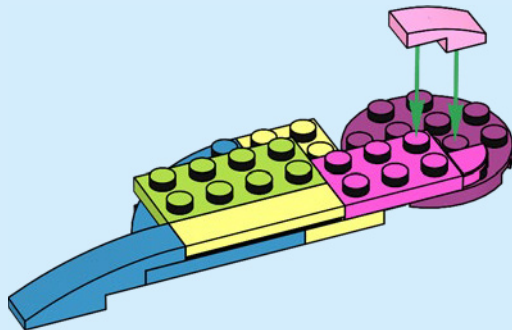



2x

67

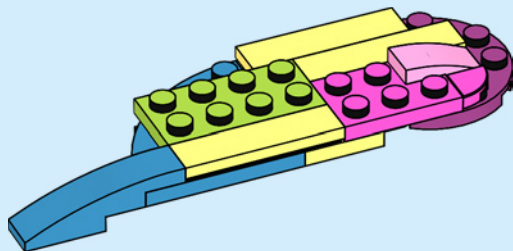

3x

68

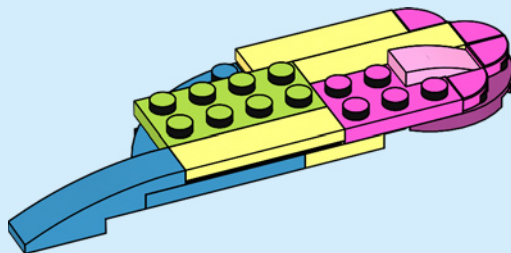



1x



1x

69

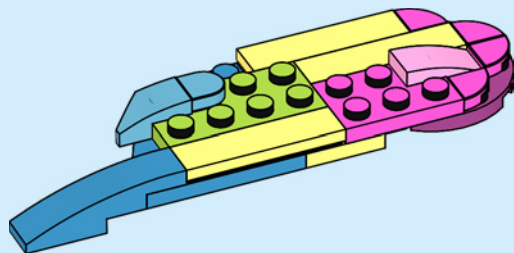

1x



1x

70

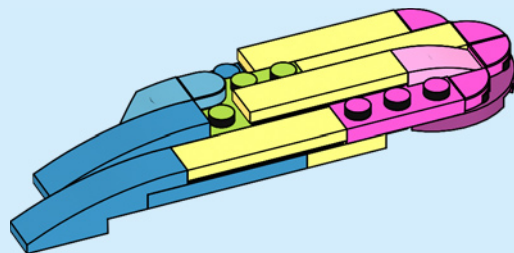



1x

71

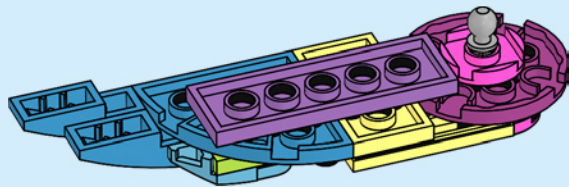
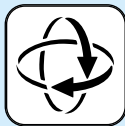

72

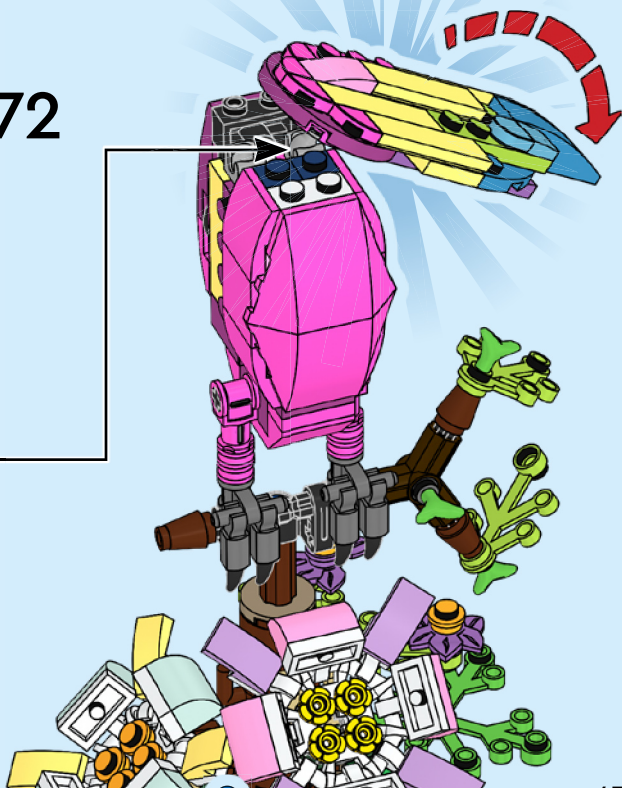

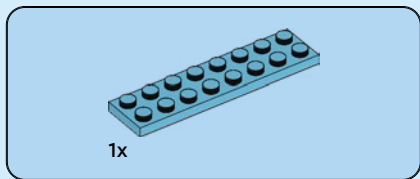
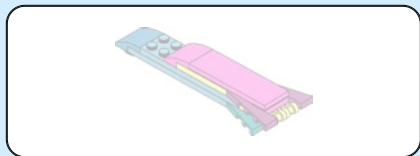

73

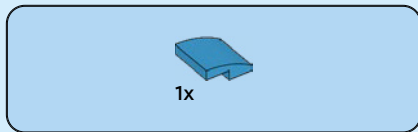
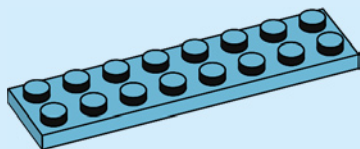

74

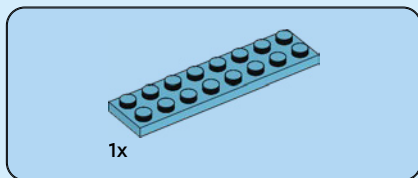
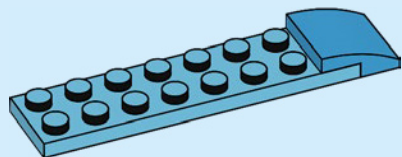

75

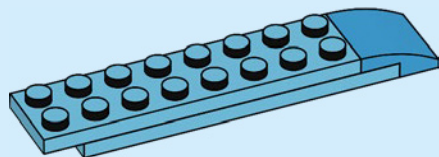



1x



1x

76

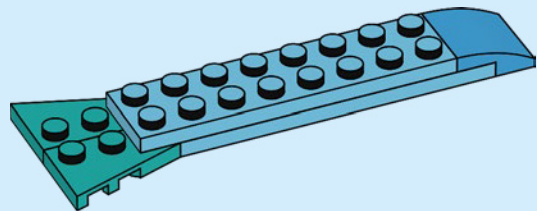

2x

77

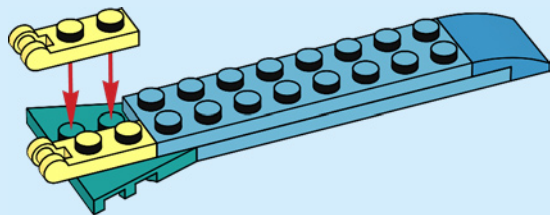

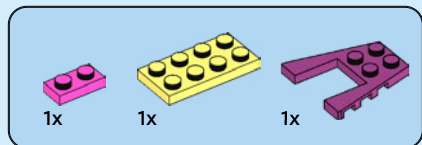

78

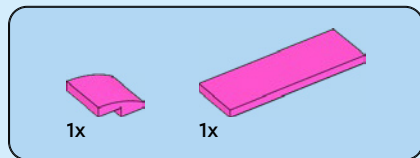
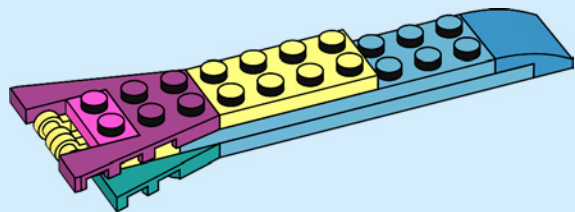

79

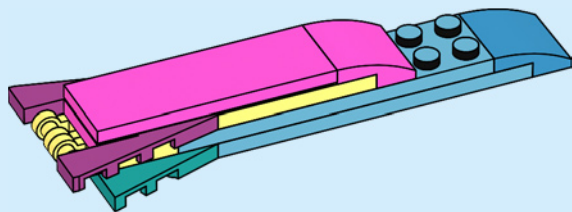



1x

80

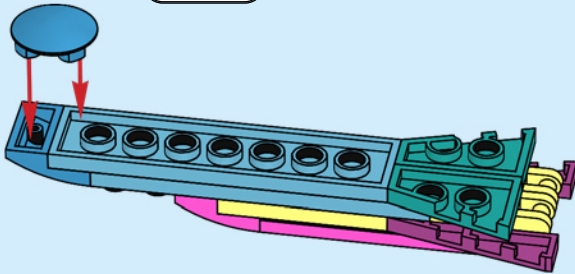

81

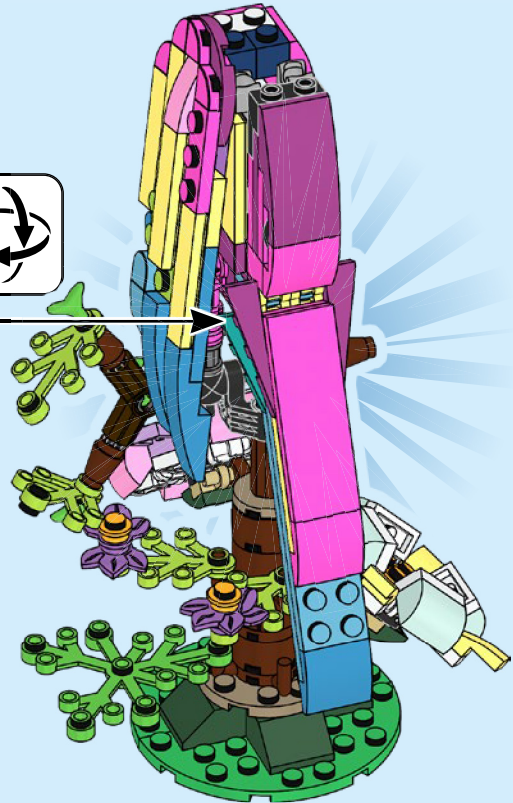

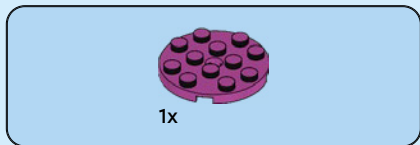
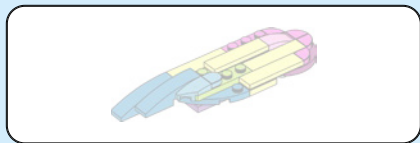

82

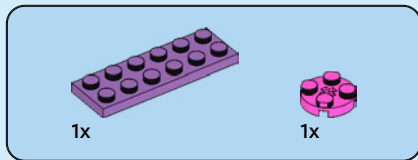
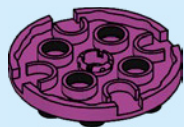

83

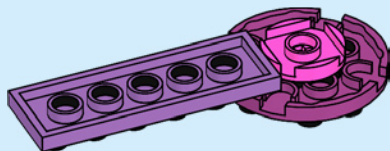

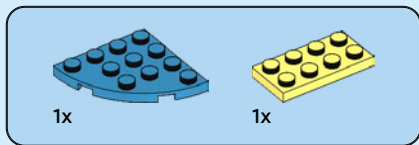

84

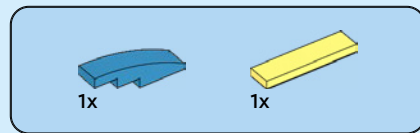
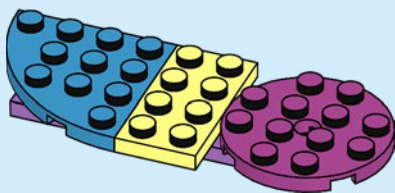
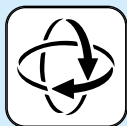

85

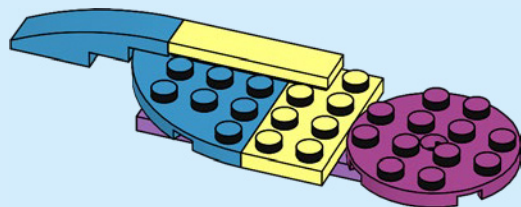

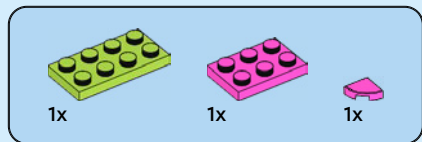

86

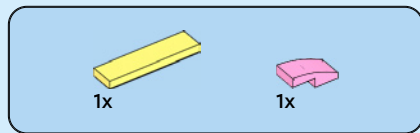
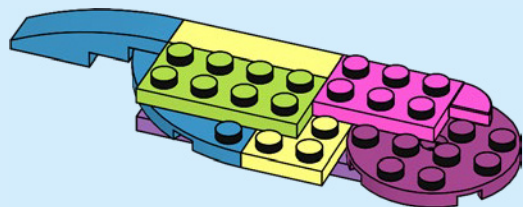

87

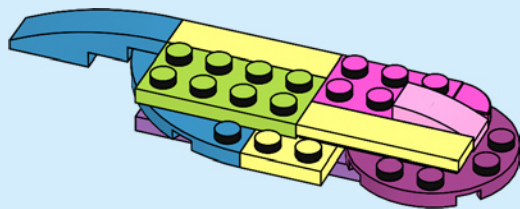



3x

88

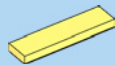
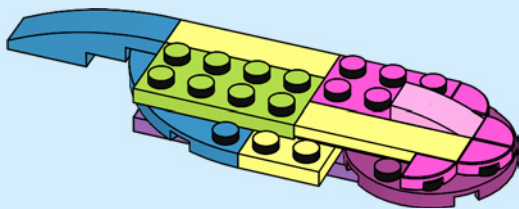

2x

89

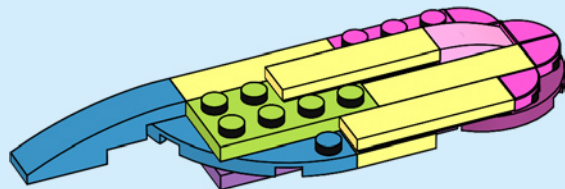

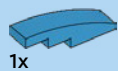

1x

90

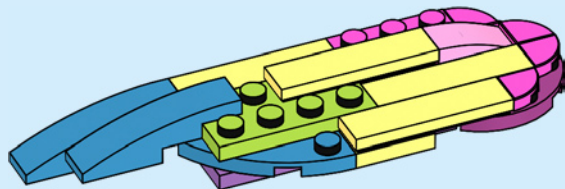

1x



1x

91

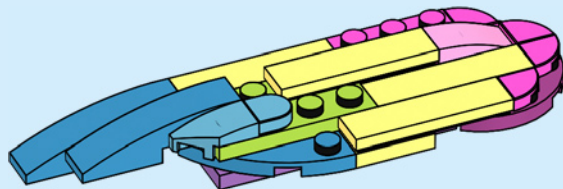



1x

92

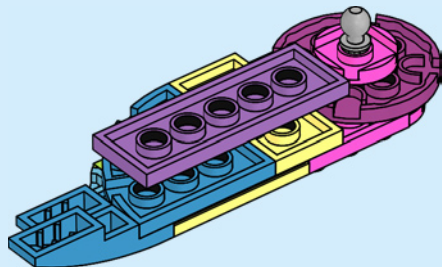
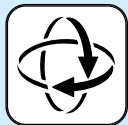

93

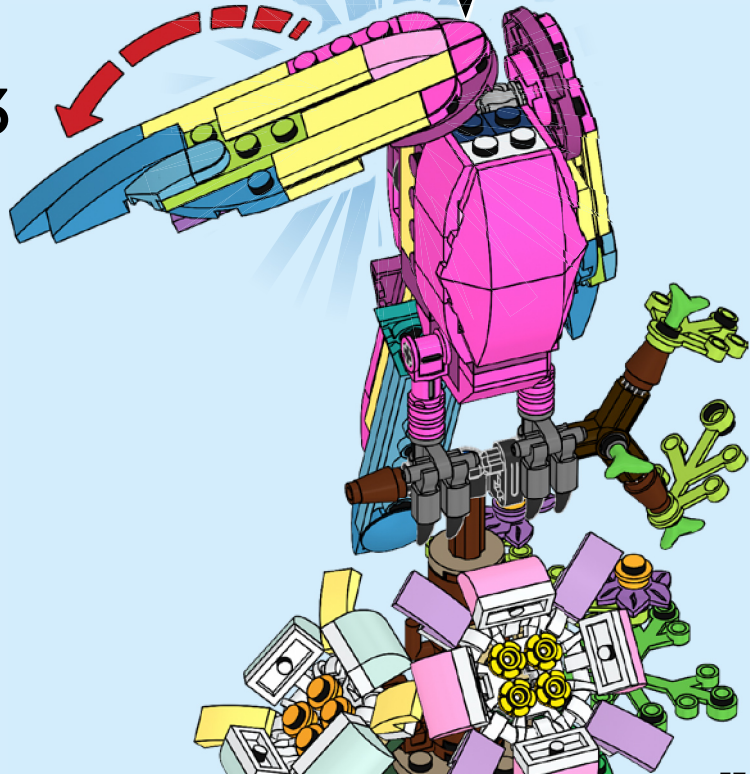

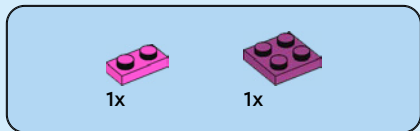
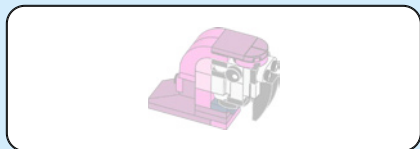

94

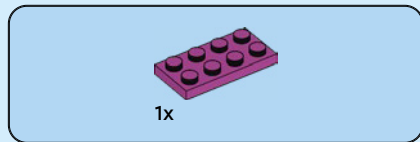
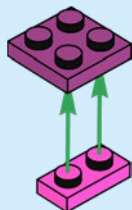

95

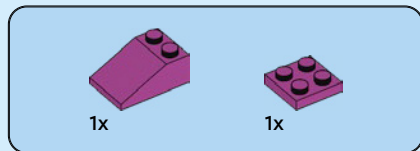
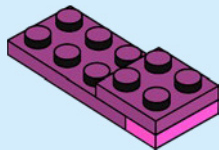

96

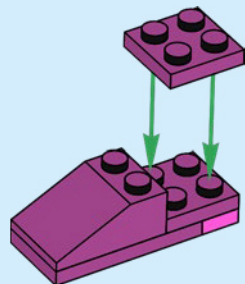



2x

97

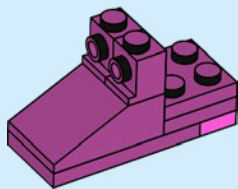

1x

98

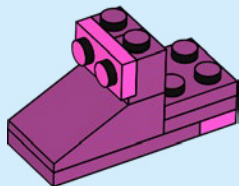

1x



1x

99

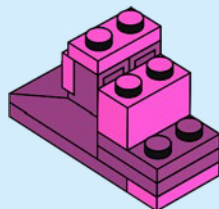

1x



1x

100

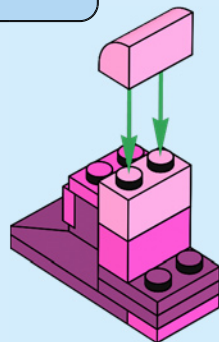

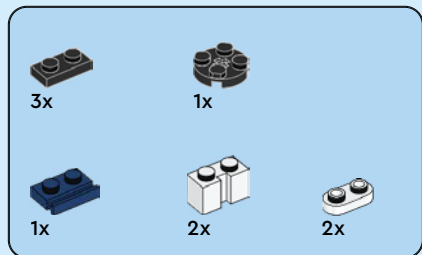

101

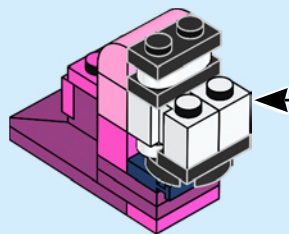
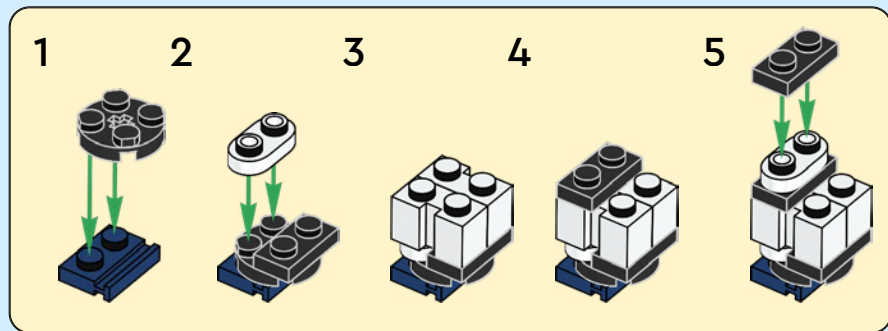

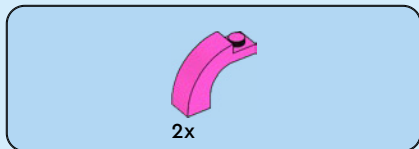

102

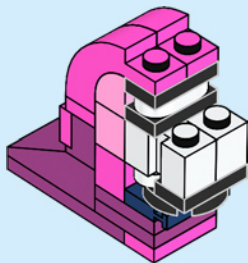

103

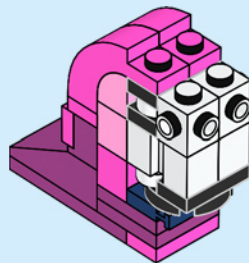



2x

104

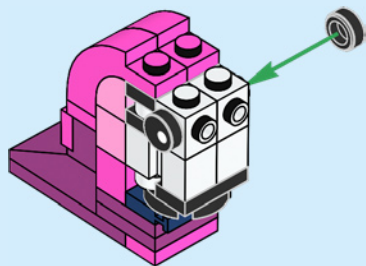

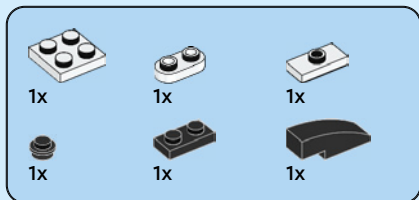

105

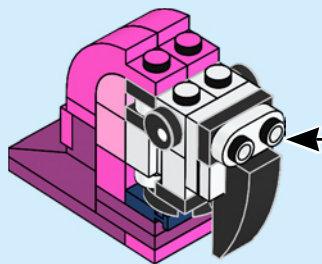
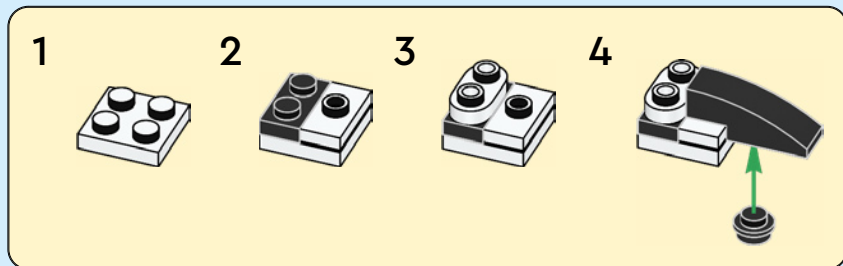



1x



1x

106

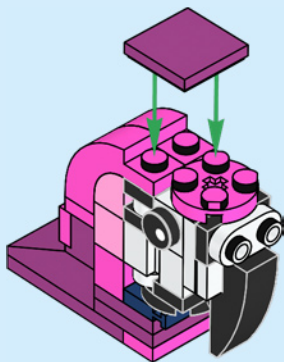

2x

107

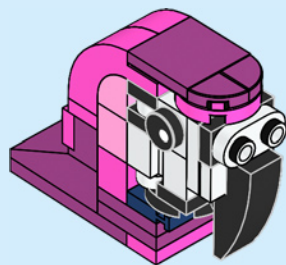

108

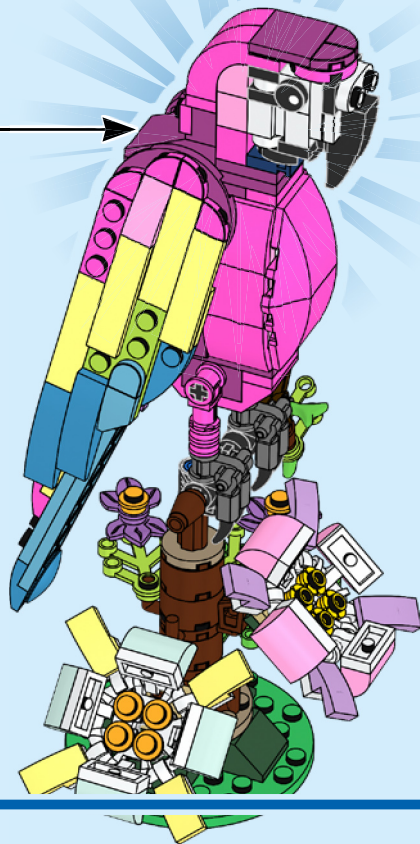





CREATOR™

3 IN 1

31137



31139



31138



31136



31135



31134



31140



CREATOR™

3
IN
1

31142



31136



31141



LEGO and the LEGO logo are trademarks of the/sont des marques de commerce du/son marcas registradas de LEGO Group.

©2023 The LEGO Group. 6474744