

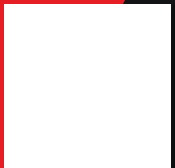

Booklet available in English on
Heft in deutscher Sprache erhältlich auf
Livret disponible en français sur
Libretto disponibile in Italiano su
Folleto disponible en español en
如需中文版手册, 请访问



WELCOME

TO LEGO® ART

Your new LEGO® Art Rolling Stones set is a unique piece of fan art. It's the first of its kind, a celebration of Rock & Roll and creativity, and your personal, creative outlet. Feel the satisfaction of disappearing into your own world and relive your favourite memories from the band's stunning career as you build.



BREAKING THE FRAMES OF THE LEGO ART CANVAS

The "Lips and Tongue" logo is perhaps the most iconic band logo in the world. The original design is so aesthetically perfect and captures the essence of The Rolling Stones' legacy; a desire for, and celebration of, creative rebellion that spans generations and cultures. This is the first time the logo has been officially created in an artwork like this in LEGO brick form, and I hope music lovers of all ages will love to explore every facet of it.

FIORELLA GROVES, *LEGO Art Creative Lead & Design Manager*

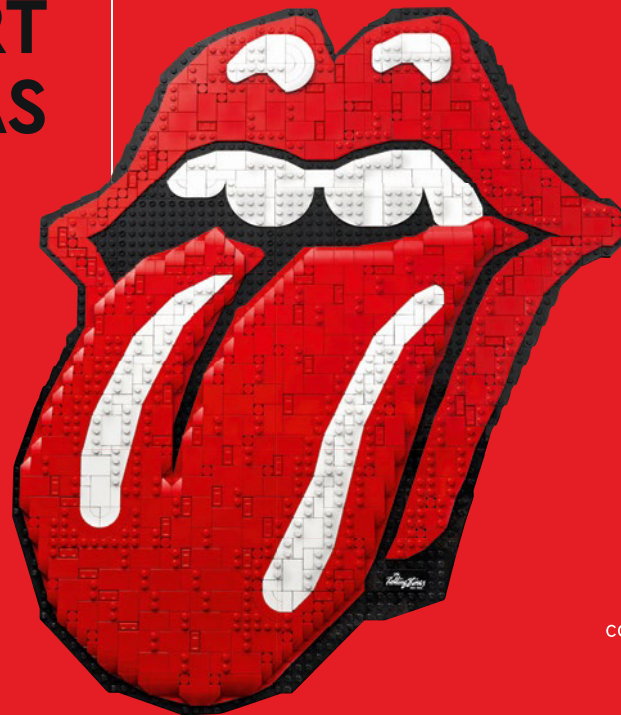

It's only a fitting tribute to The Rolling Stones, who transcend barriers in everything they do, that we break the frames of our standard LEGO Art canvas in this set. Triangular, square and rectangular elements make up the logo's organic curves and capture its raw, edgy energy. The model is intuitive and engaging to build, and the colourful built-in layers serve both as technical solutions and foundation for the relief artwork, fun surprises and our hat tip to this colourful band.

ANNEMETTE BAASKJÆR NIELSEN, *LEGO Art Model Designer*



THE STORY BEHIND THE FAMOUS "LIPS AND TONGUE" LOGO

The original "Lips and Tongue" design was created by a young art student, John Pasche, in 1970. Inspired by Indian music and culture, the band presented Pasche with an image of the Hindu goddess Kali (usually portrayed with her tongue sticking out) as a style reference. Pasche opted for a modern interpretation that was sleek, stylish and fittingly defiant. The striking image became instantly synonymous with the band and their recording label, Rolling Stones Records, after it appeared on the *Sticky Fingers* album cover and sleeve

in 1971. It epitomised a new era in music, culture, fashion and art and fans immediately embraced the logo as a symbol of anti-establishment, unapologetic creativity and free-spirited self-expression.

The logo has been on every Rolling Stones album since. Over the years, various artists have created unique iterations for special releases and occasions. Its timeless aesthetic still appeals to fans of all ages and is an integrated part of the band's graphic materials, scenography and merchandise.



ROLLING MILESTONES

Formed in 1962, The Rolling Stones first knocked the socks off the world of music, and the world in general, with *(I Can't Get No) Satisfaction* in 1965. It's hard to overstate the influence the band has had on music history and culture over the span of six decades (and counting), from defining the early roots of Rock & Roll to dominating world stages and playlists in the age of digital music. With dozens of albums and thousands of breath-taking and charismatic performances, they remain one of the best-selling groups of all time.

The members of The Rolling Stones, as well as their famous logo, have long been brands in their own rights and synonymous with the original British Rock & Roll lifestyle, always challenging the status quo, and inspiring generations to express their creativity in their own ways. Influenced by different genres and world music, they have incorporated blues, punk, R&B, jazz, country, psychedelic music, disco, ballads and much more into their music, always with authenticity and curiosity. With equal parts reckless abandon and profound respect for all genres, they continually surprise their audiences and make room for each other's creative twists and playful experiments.



it's only
Rock n' roll

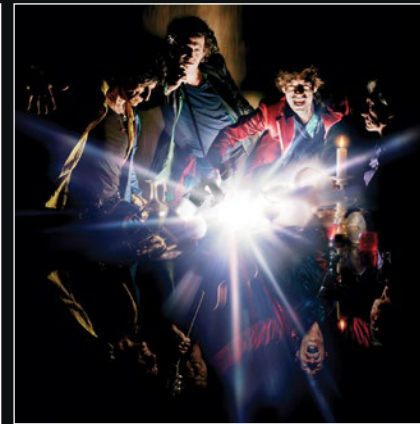
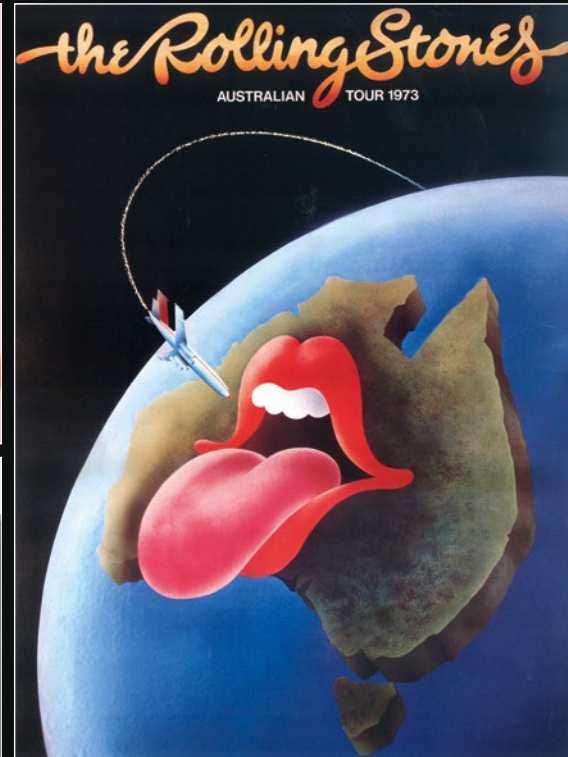
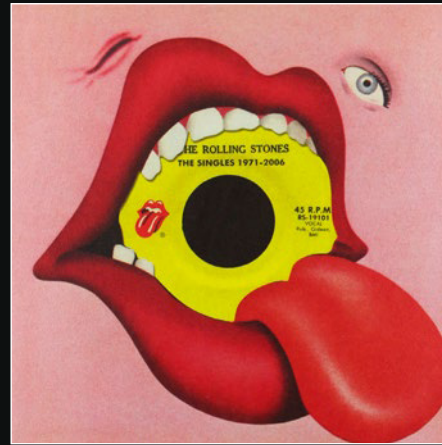



BUILD AND DISPLAY YOUR WAY

Every LEGO® Art element plays a part in the big picture but, in the spirit of creativity, who are we to say you can't rebuild it your way? Get an all-access backstage pass to the stories and inspiration behind both the logo and the LEGO Art design as you build – just download the exclusive Soundtrack and press play. (Sorry, not available on vinyl.) And then all you need to do is find the perfect place to display your own piece of Rock & Roll art history.





LISTEN

Scan the QR code to tune into the exclusive Soundtrack curated around the LEGO® Art Rolling Stones set.

BUILD

Channel your inner (or outer) Rock & Roll star as you build and watch your artwork take form.

RELAX

This set is your personal VIP ticket to unwind, de-stress and relax with a tribute to your favourite band.

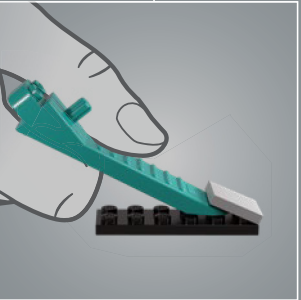
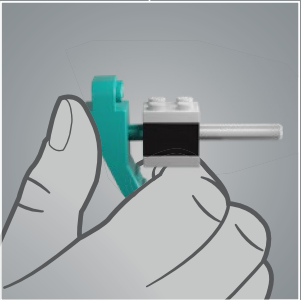
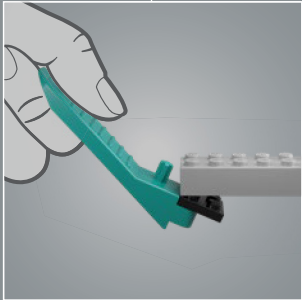
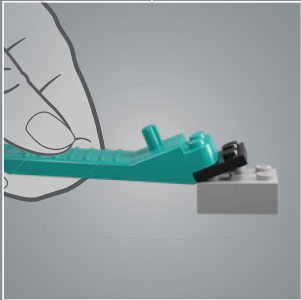
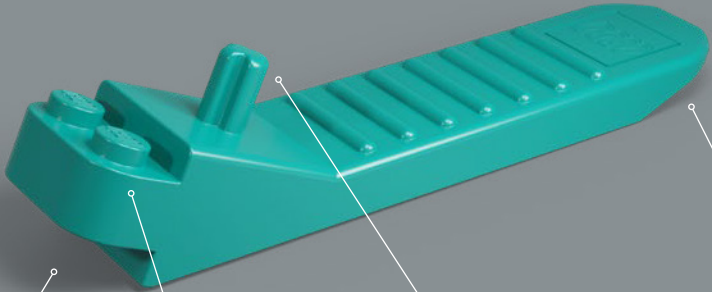

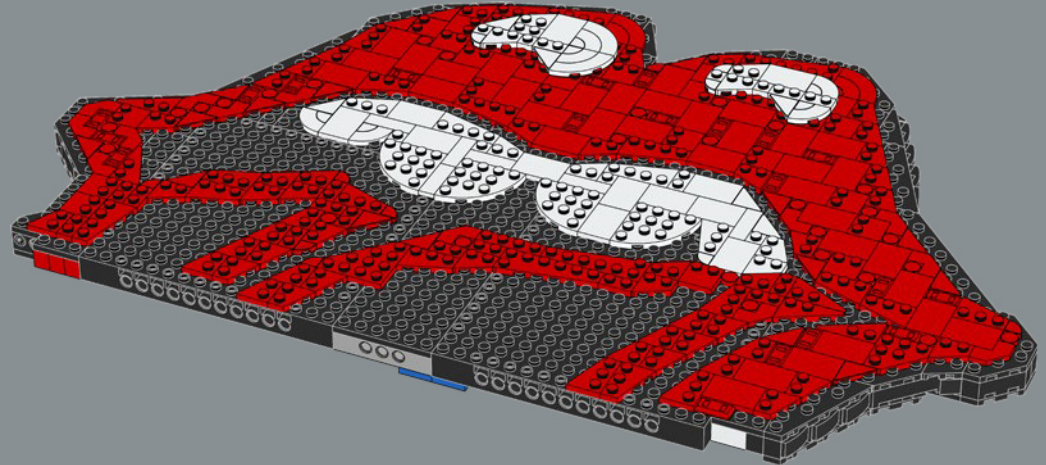
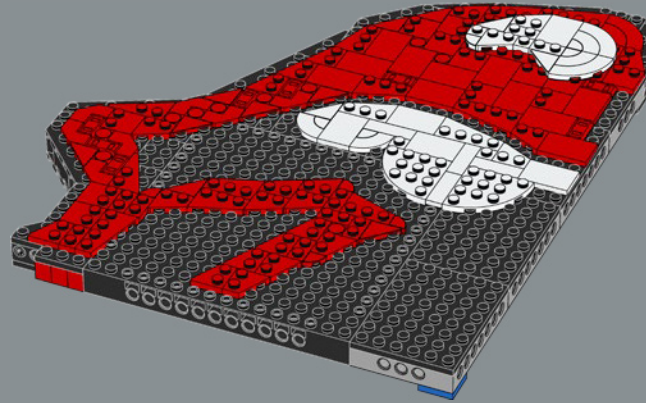

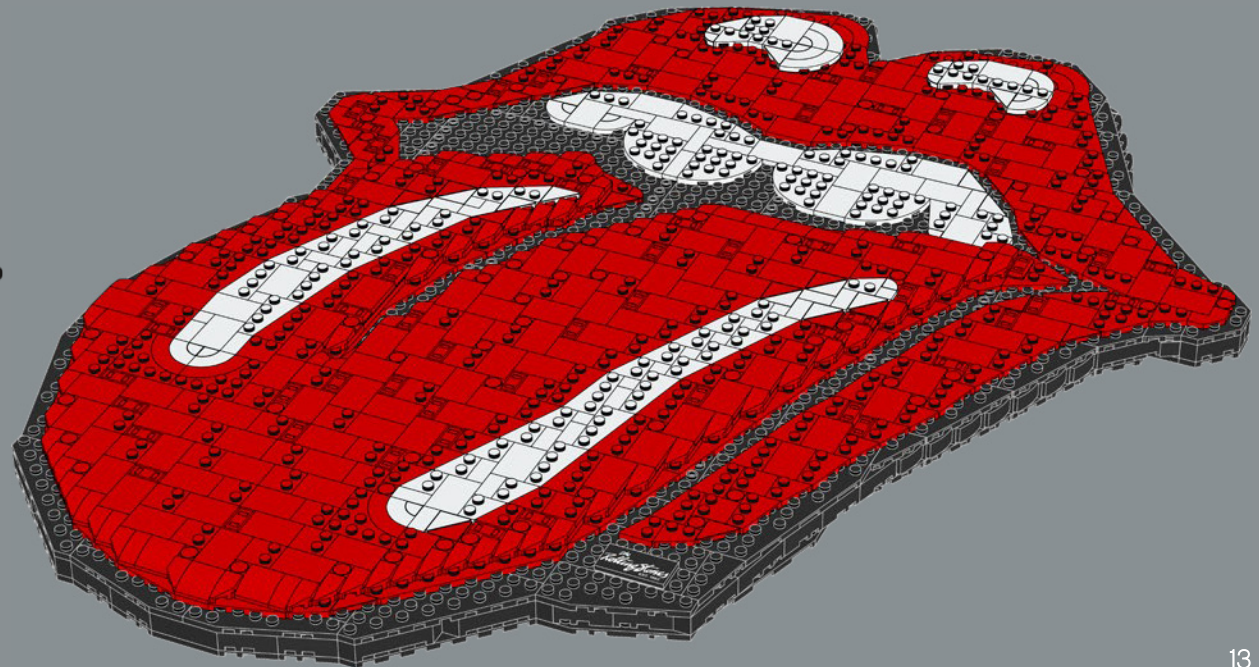
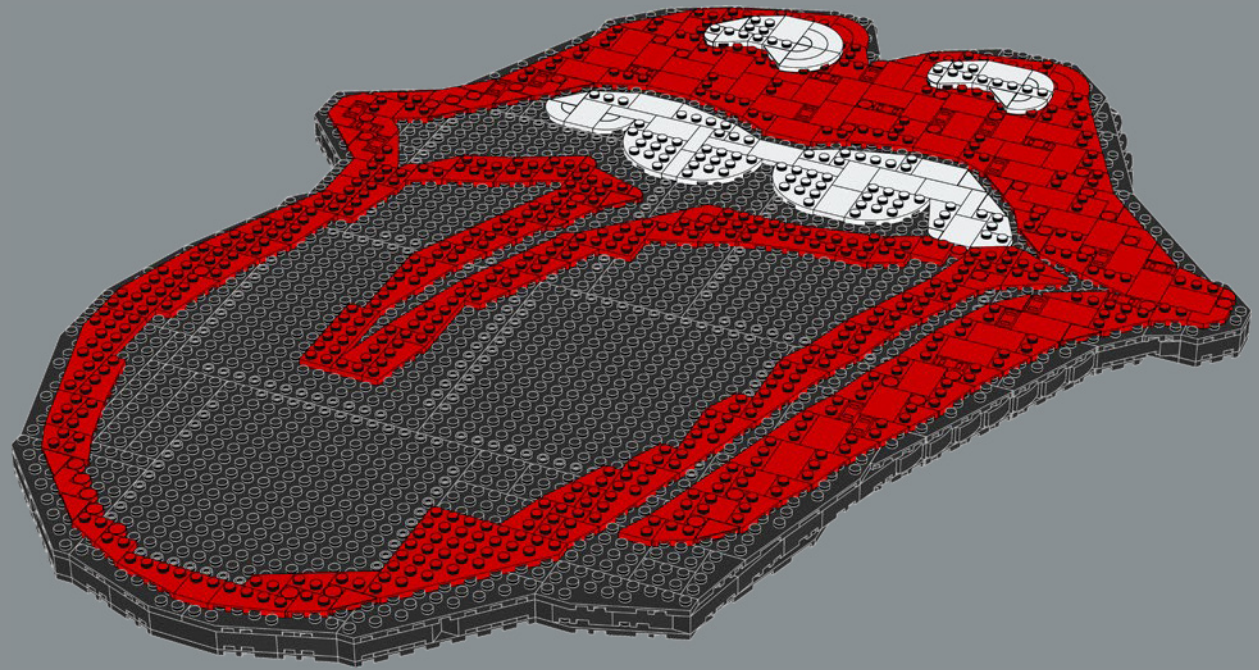

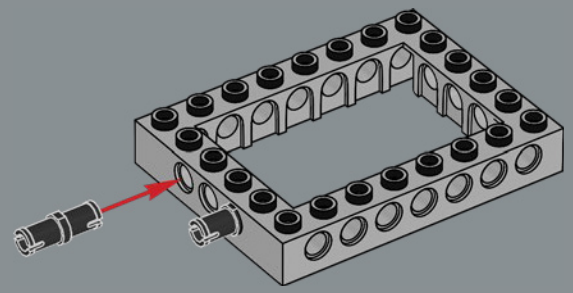
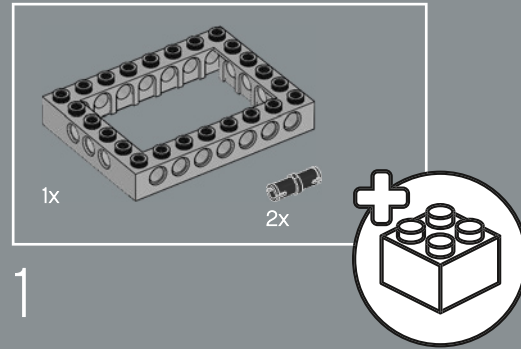
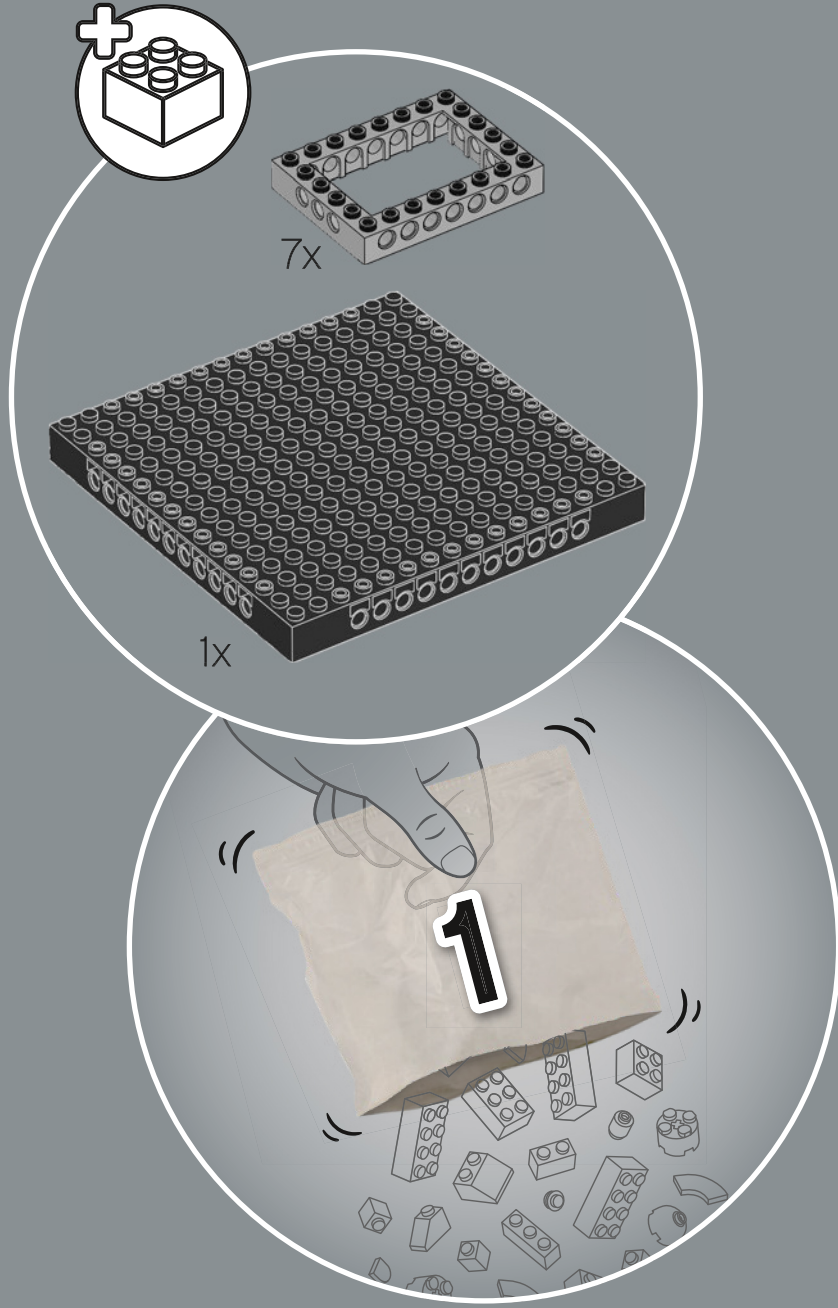

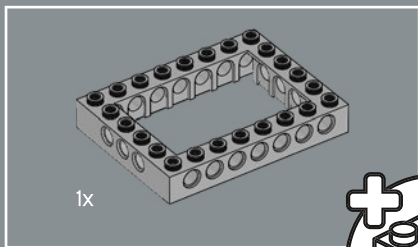

2

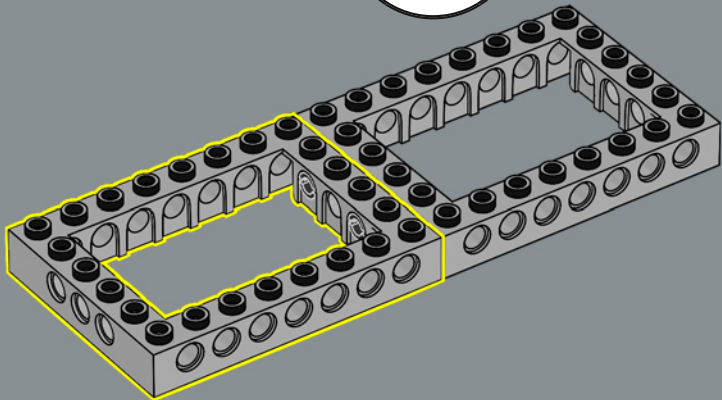
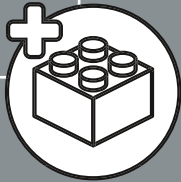

3

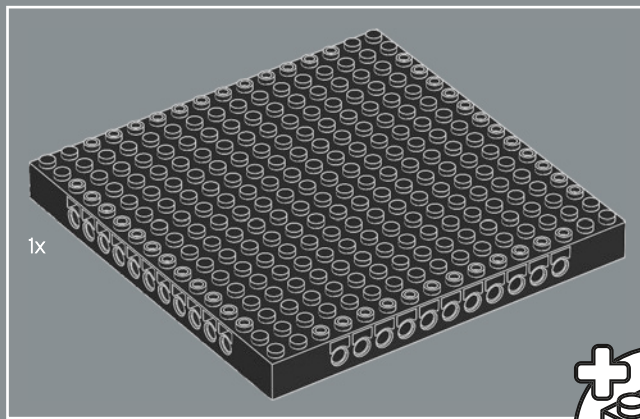
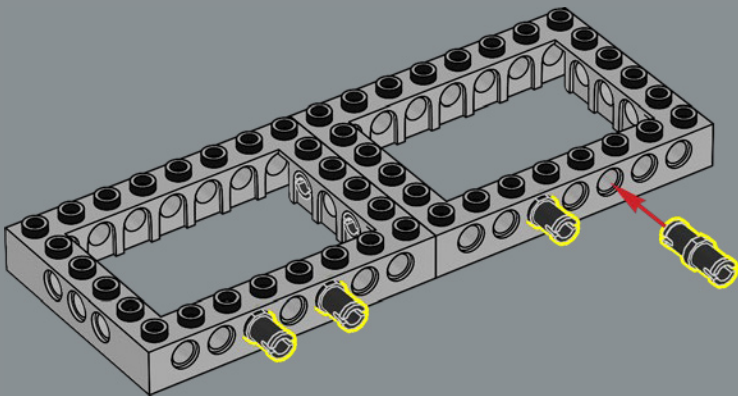

4

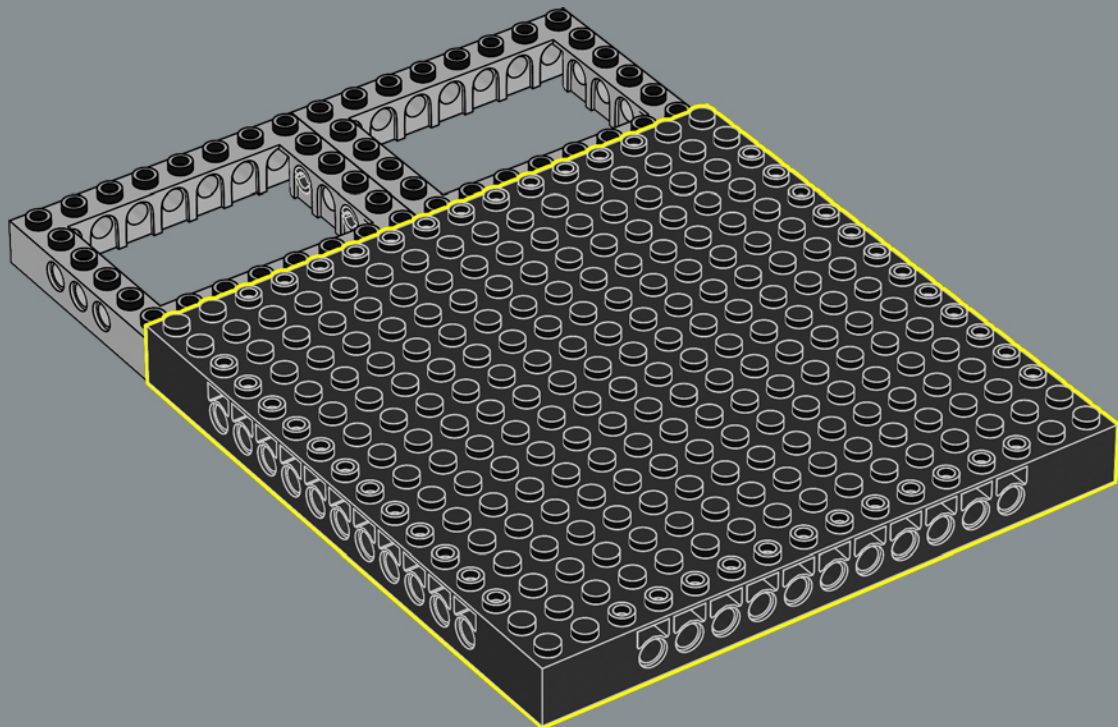
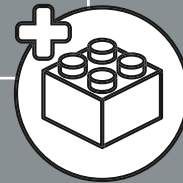

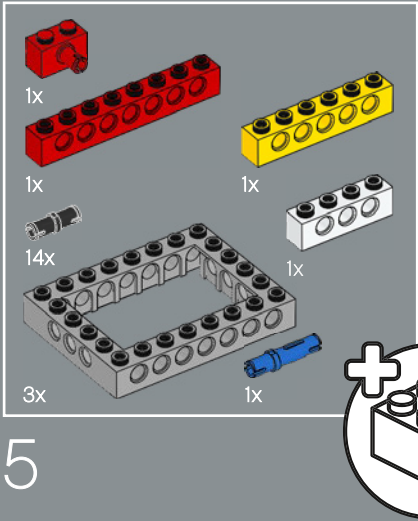
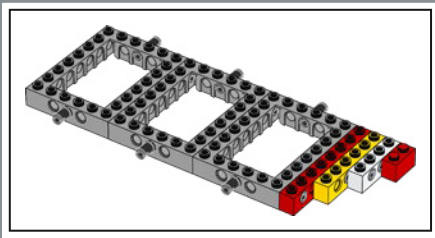

5

1

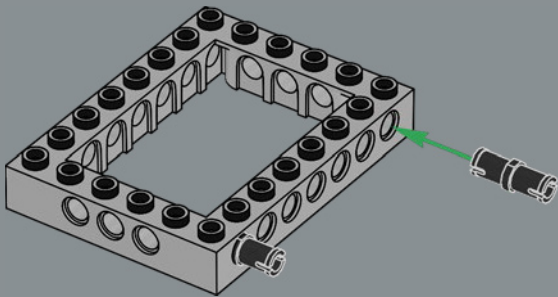

2

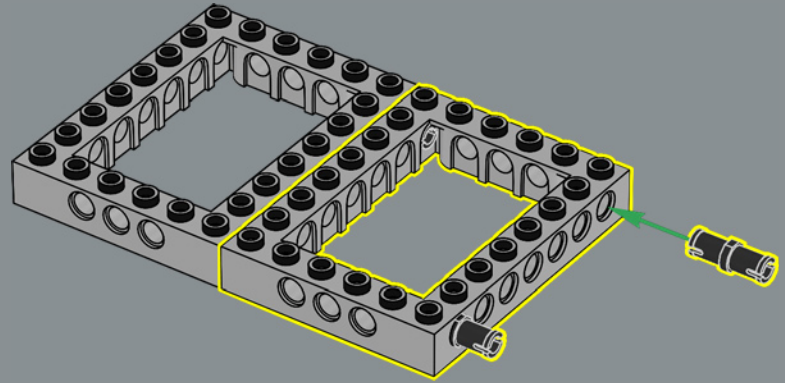

3

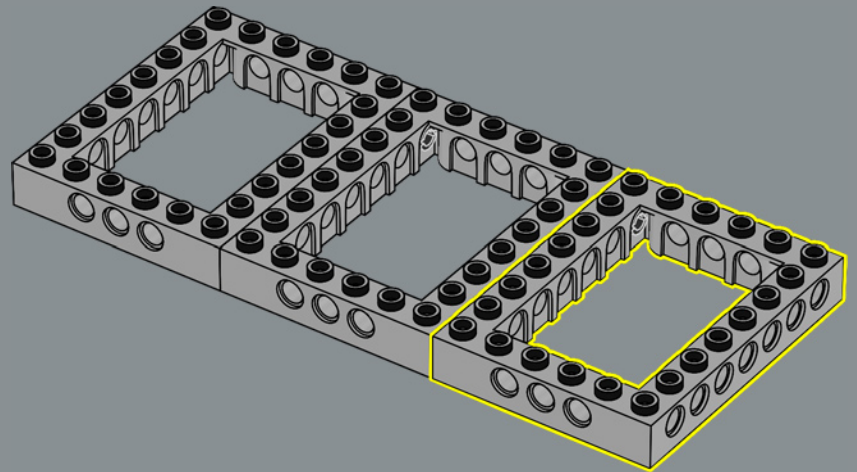

4

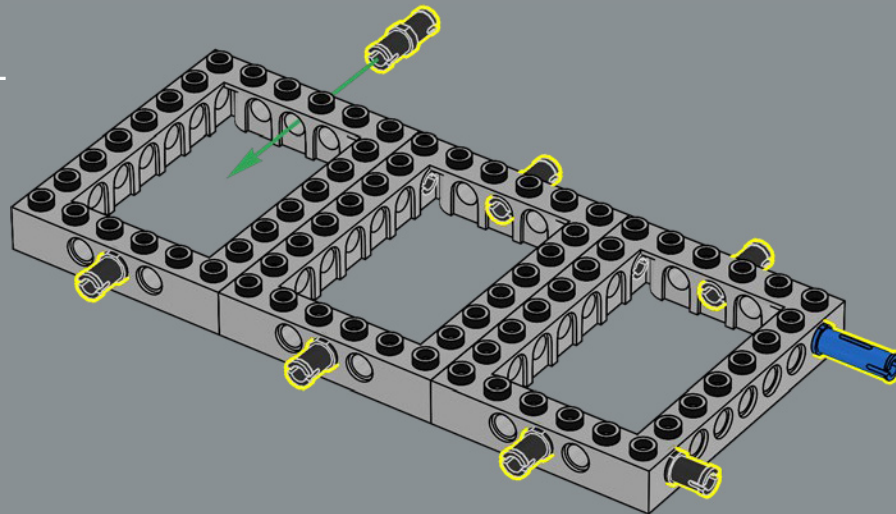

5

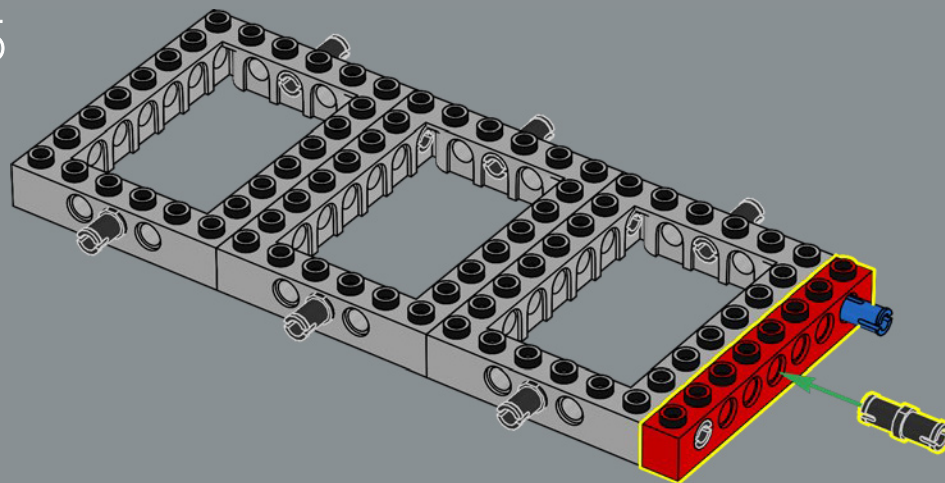

6

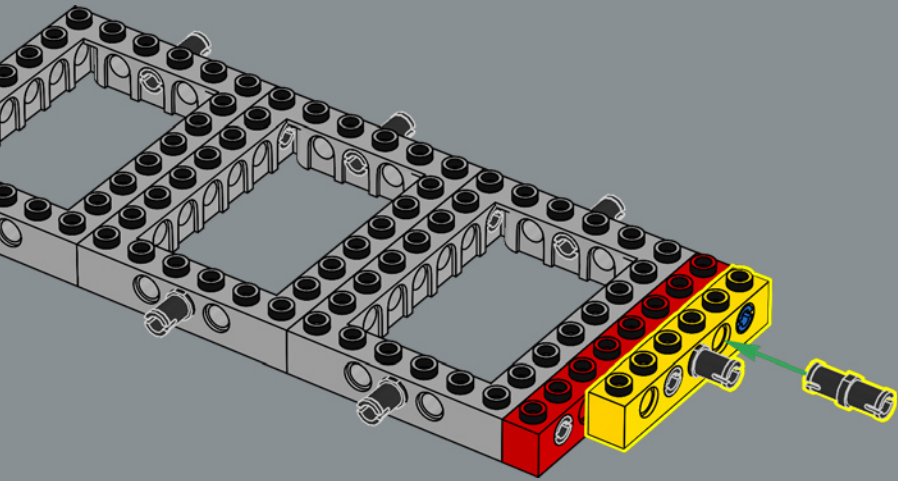

7

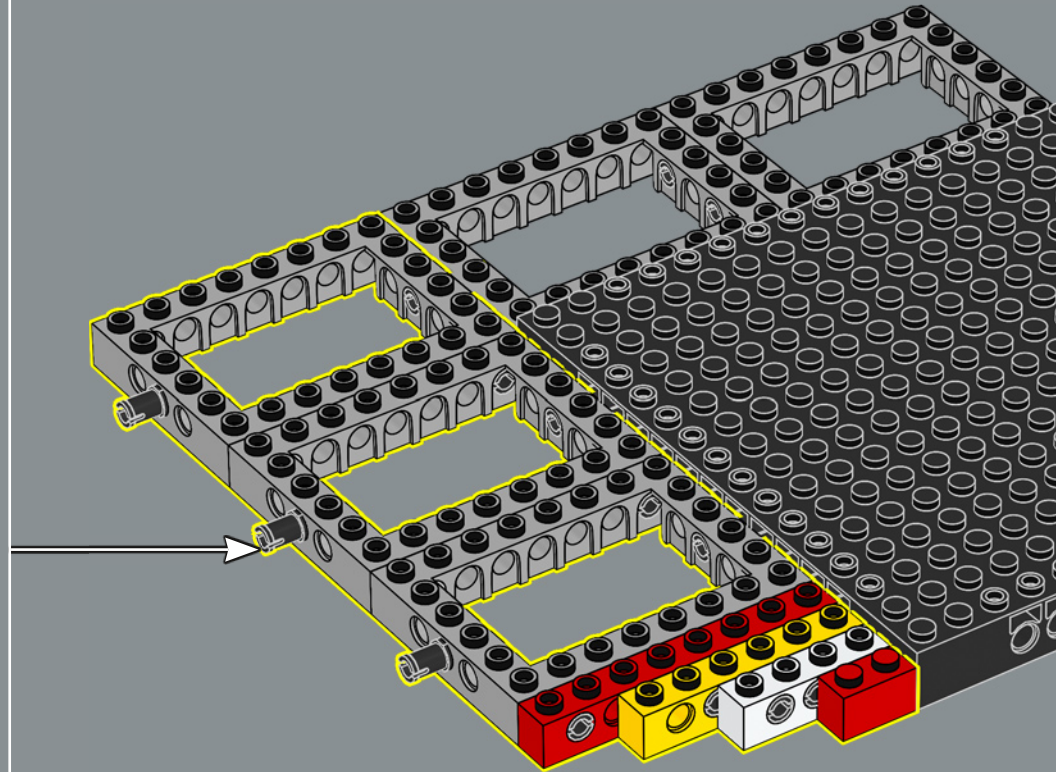
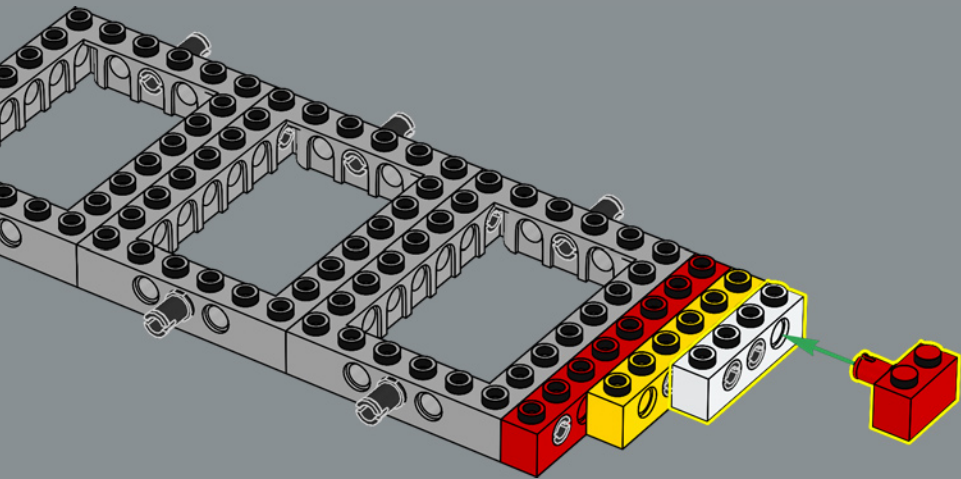

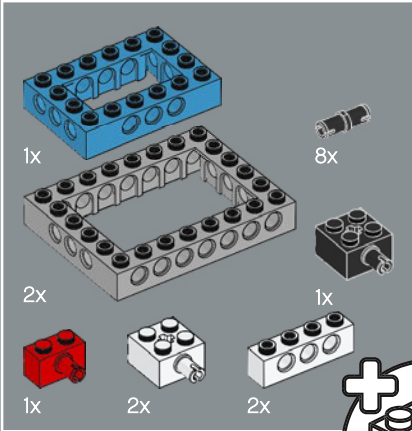
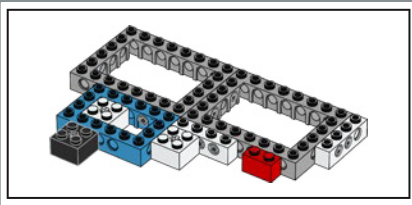

6

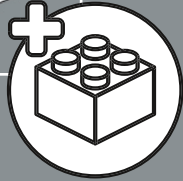

1

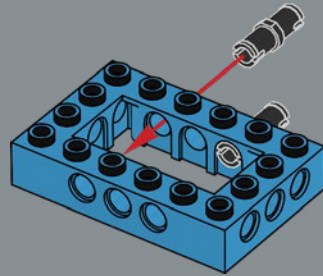

2

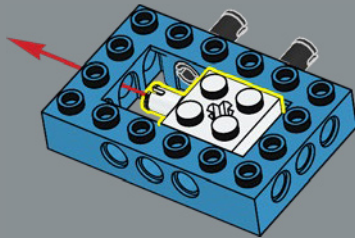

3

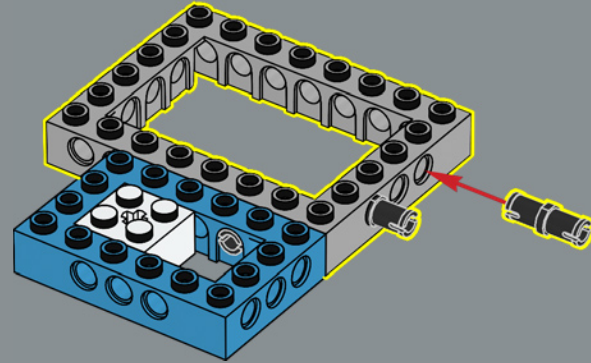

4

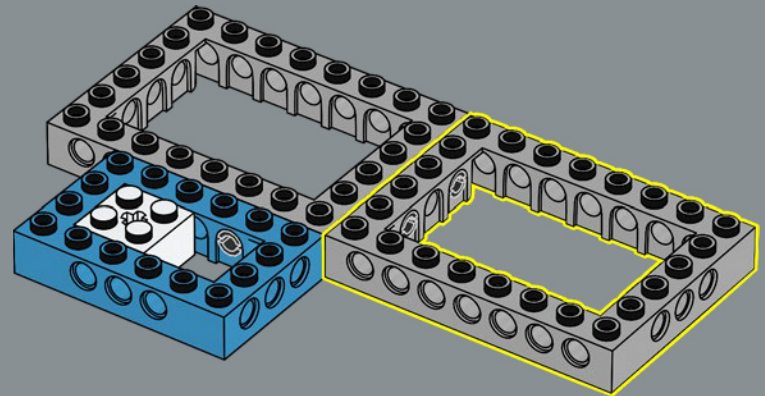

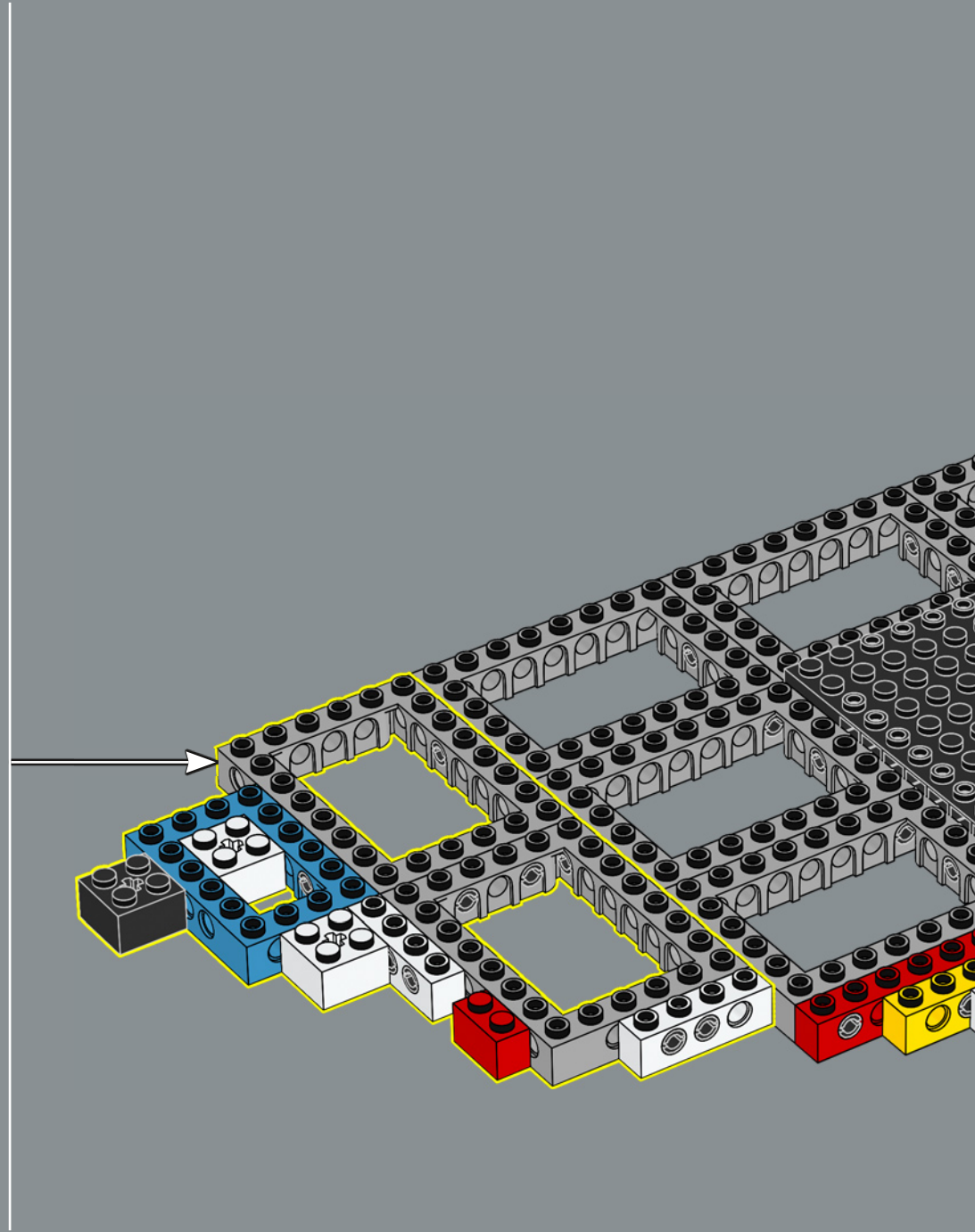
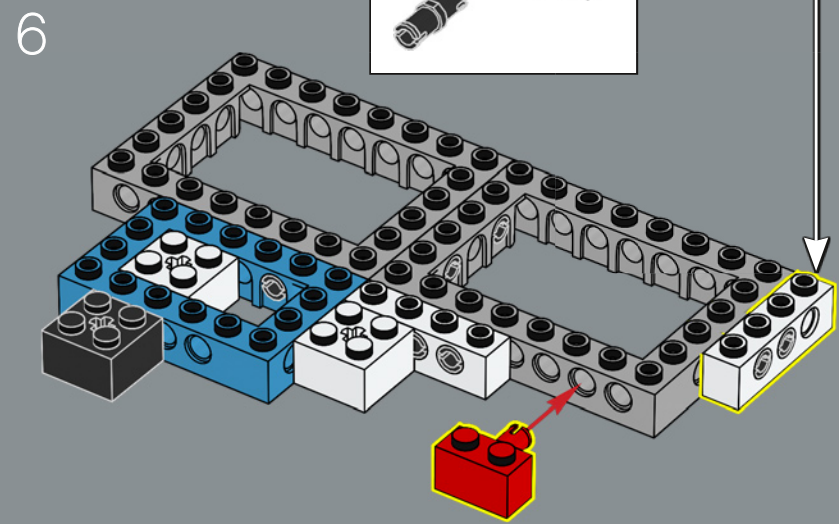
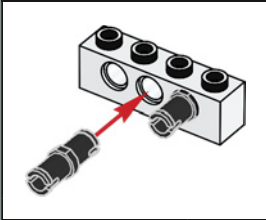
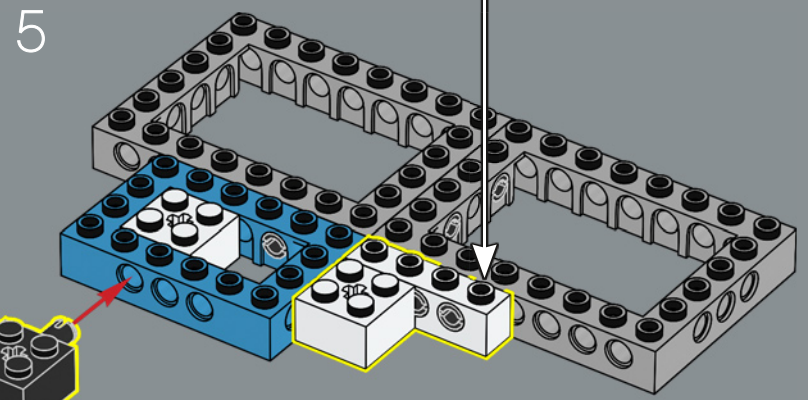
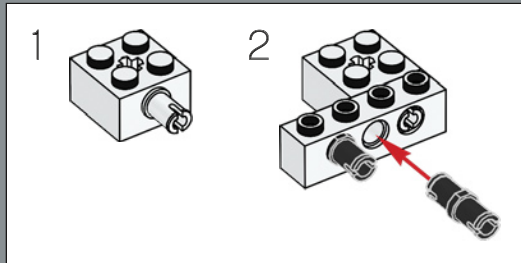

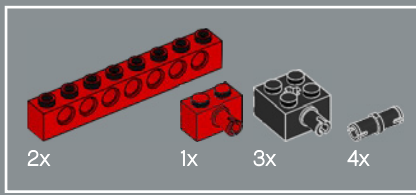

7

1

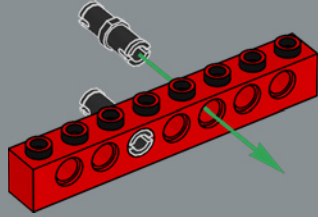

2

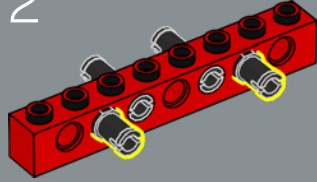

3

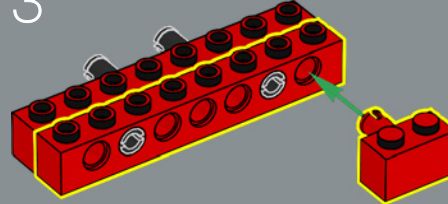

4

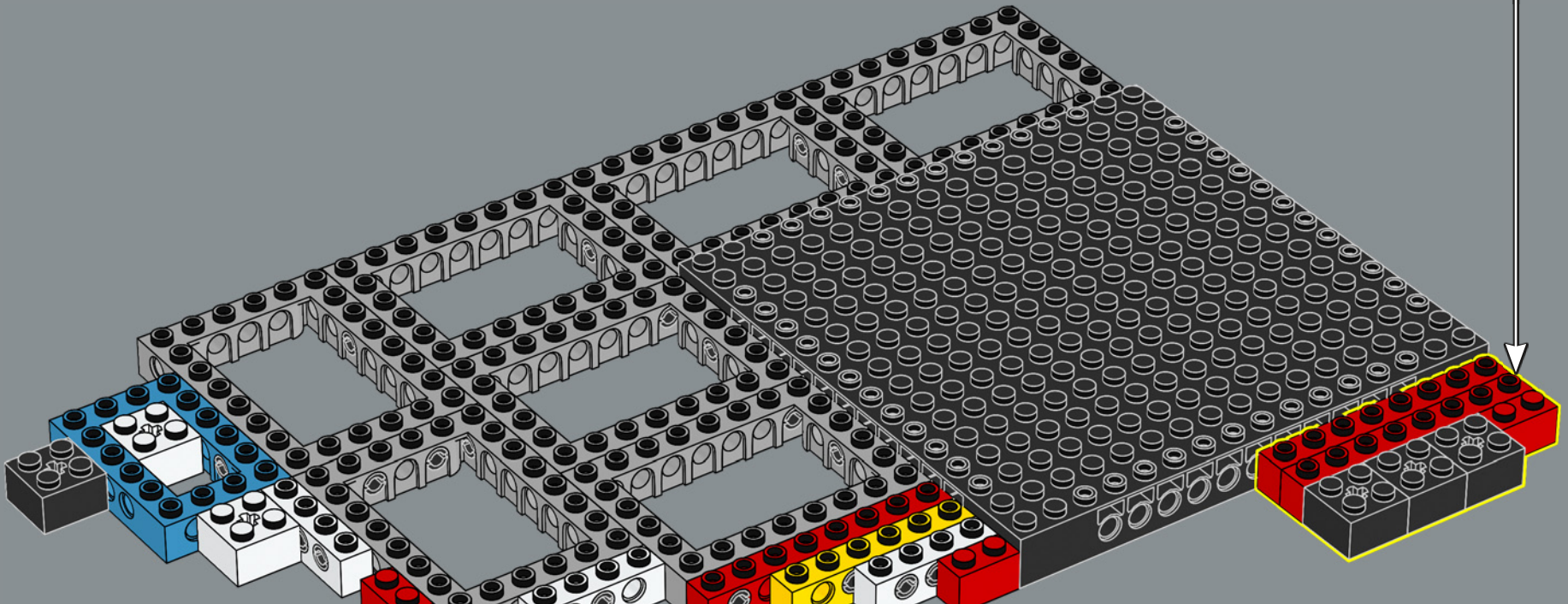
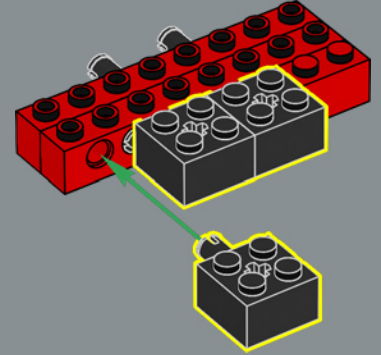

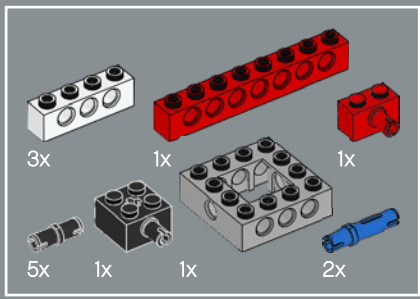

8

1

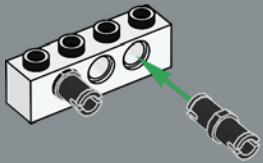

2

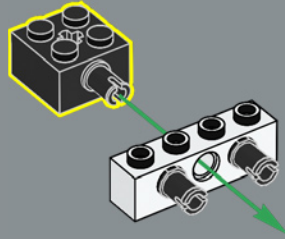

3

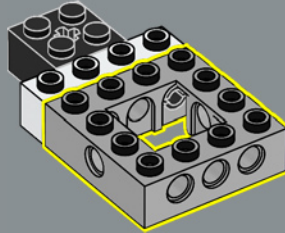

4

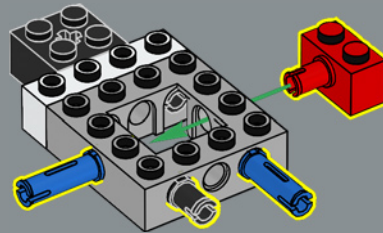

5

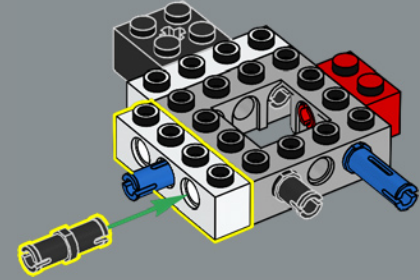

6

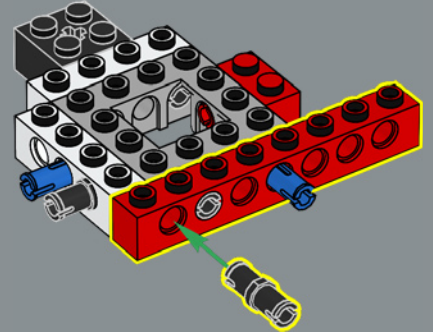

7

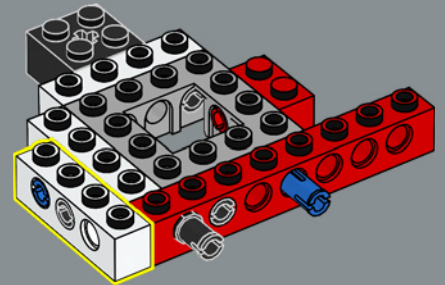

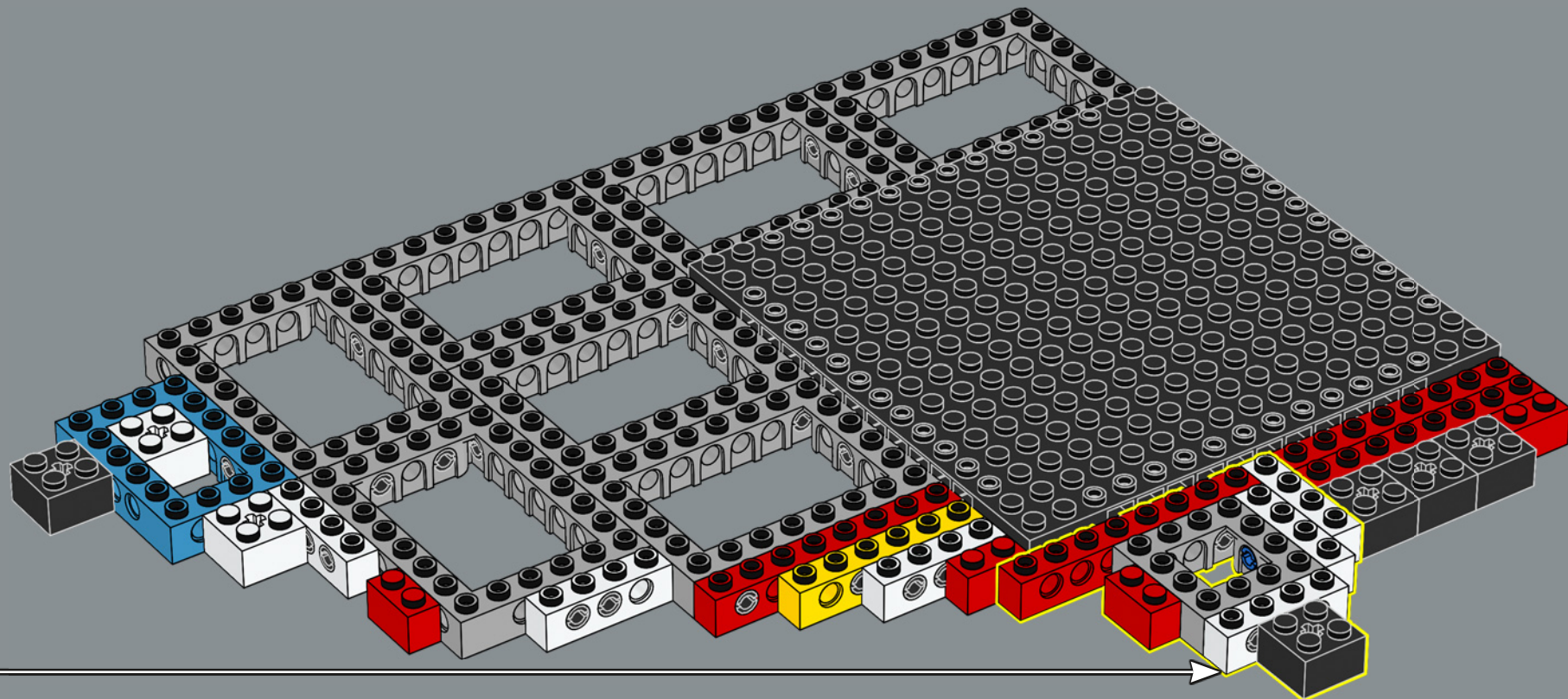

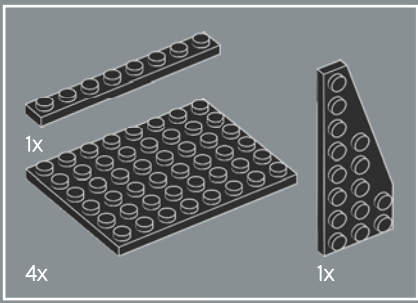

9

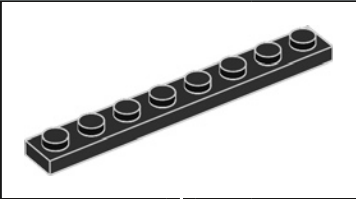
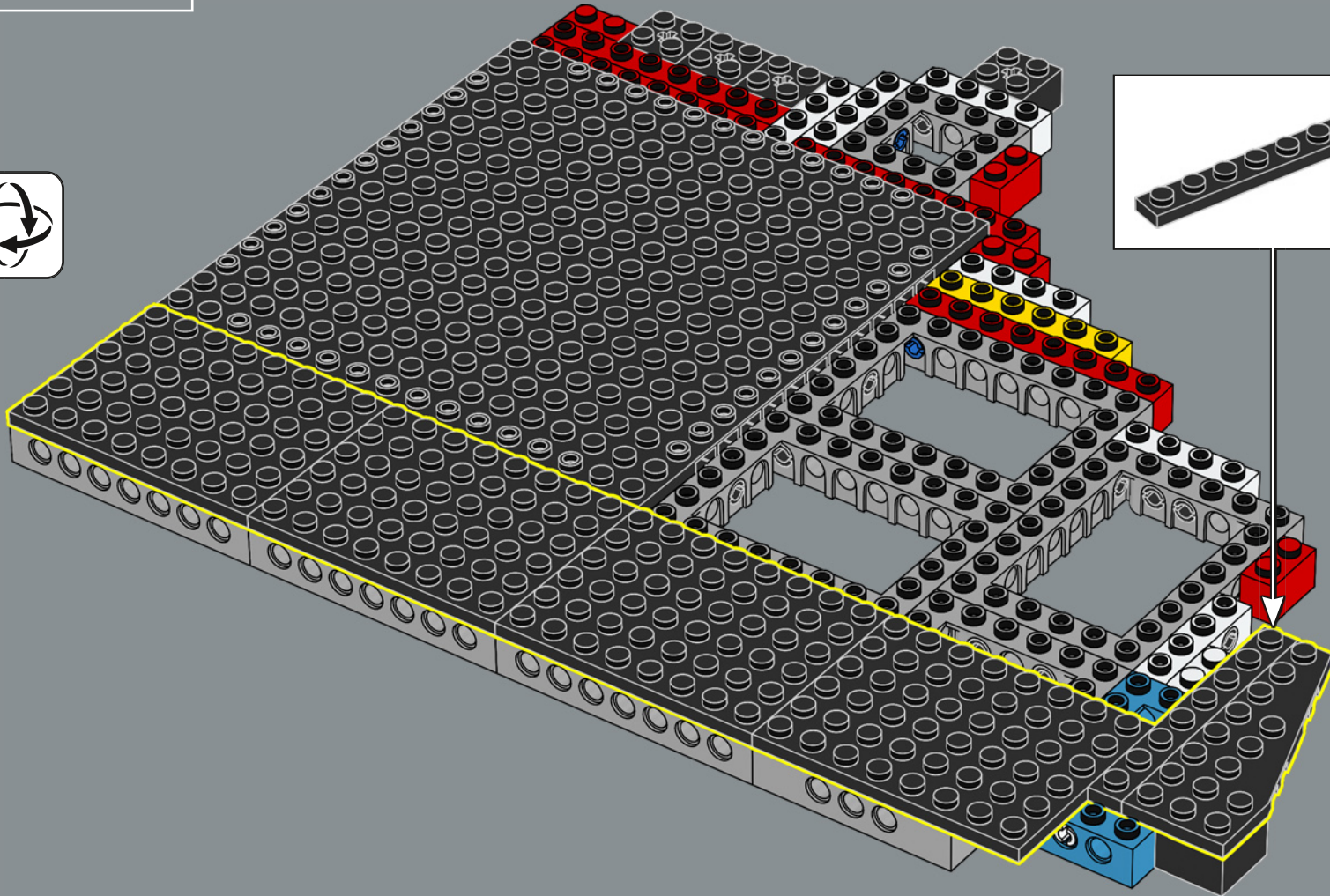

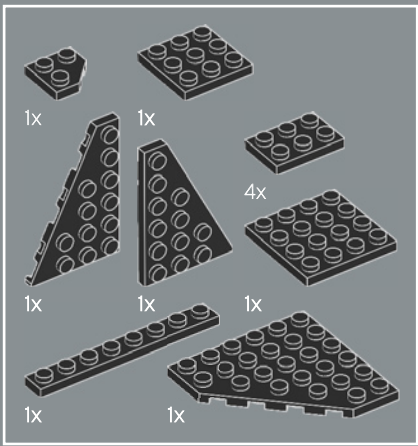

11

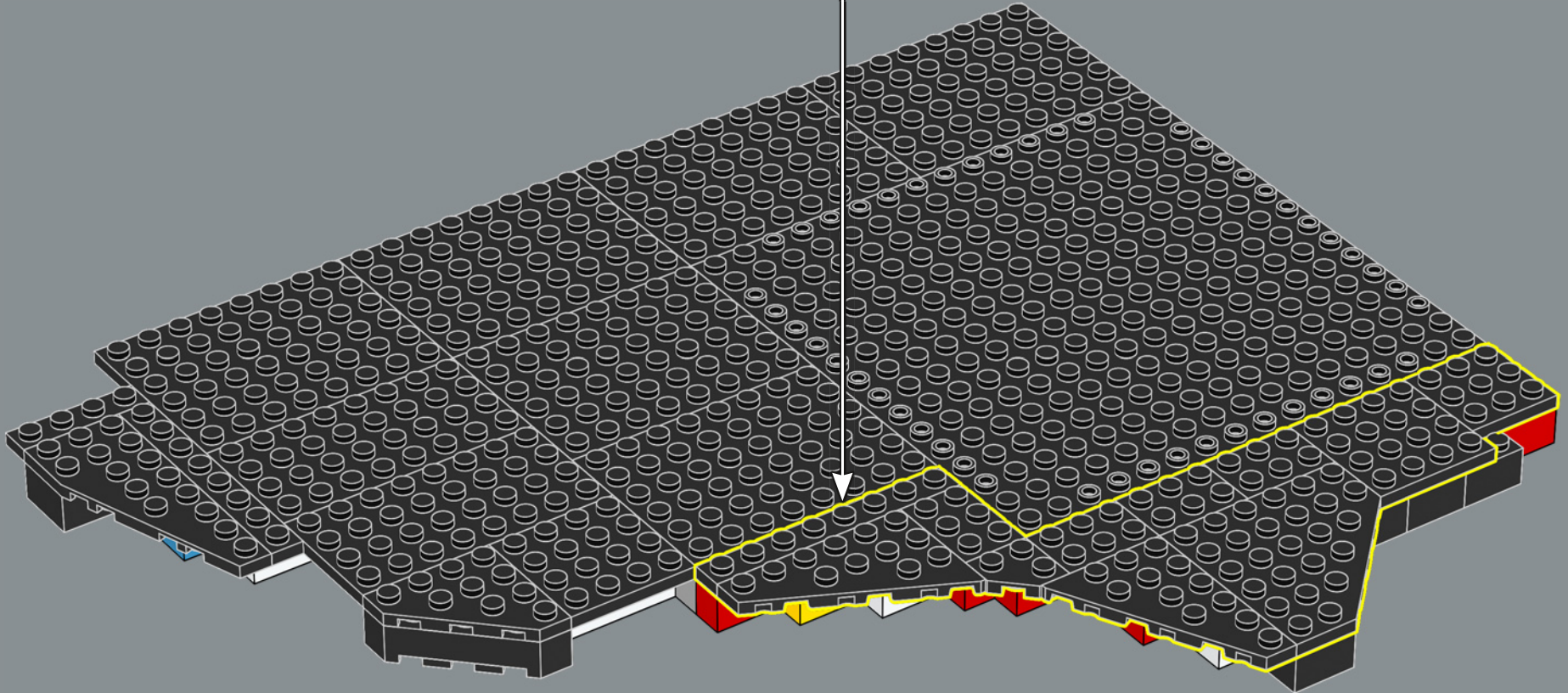
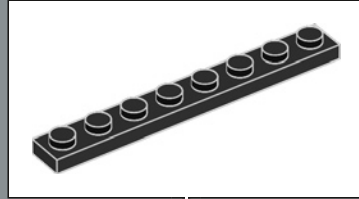

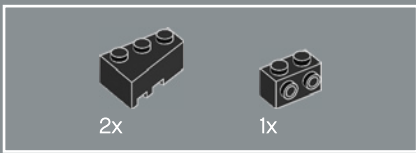

12

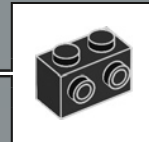
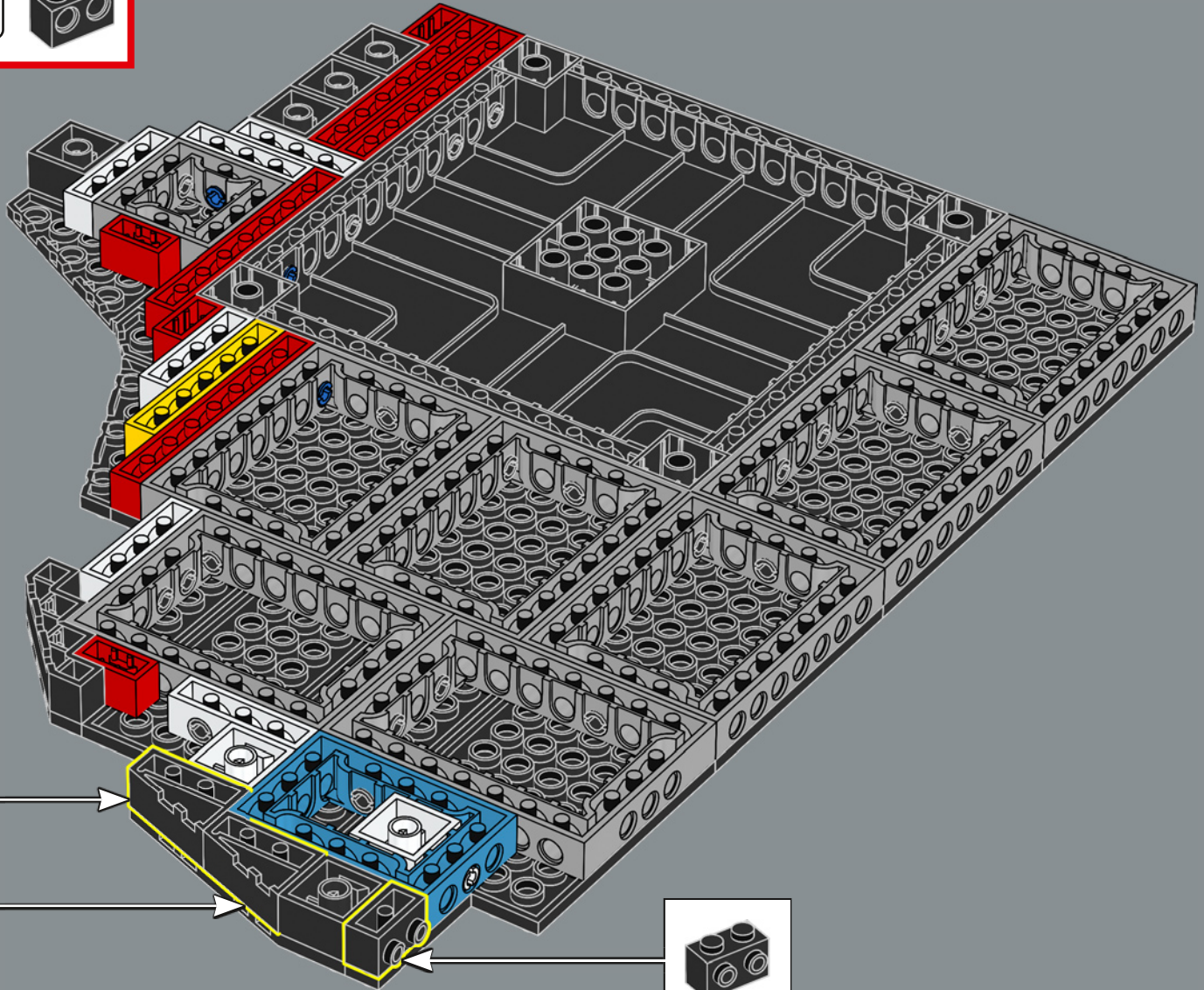
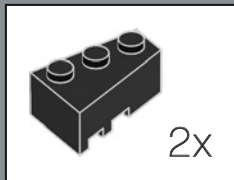
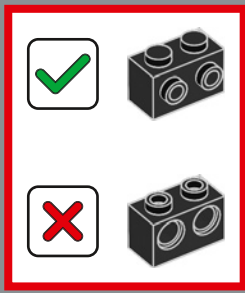

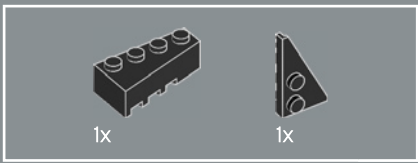

13

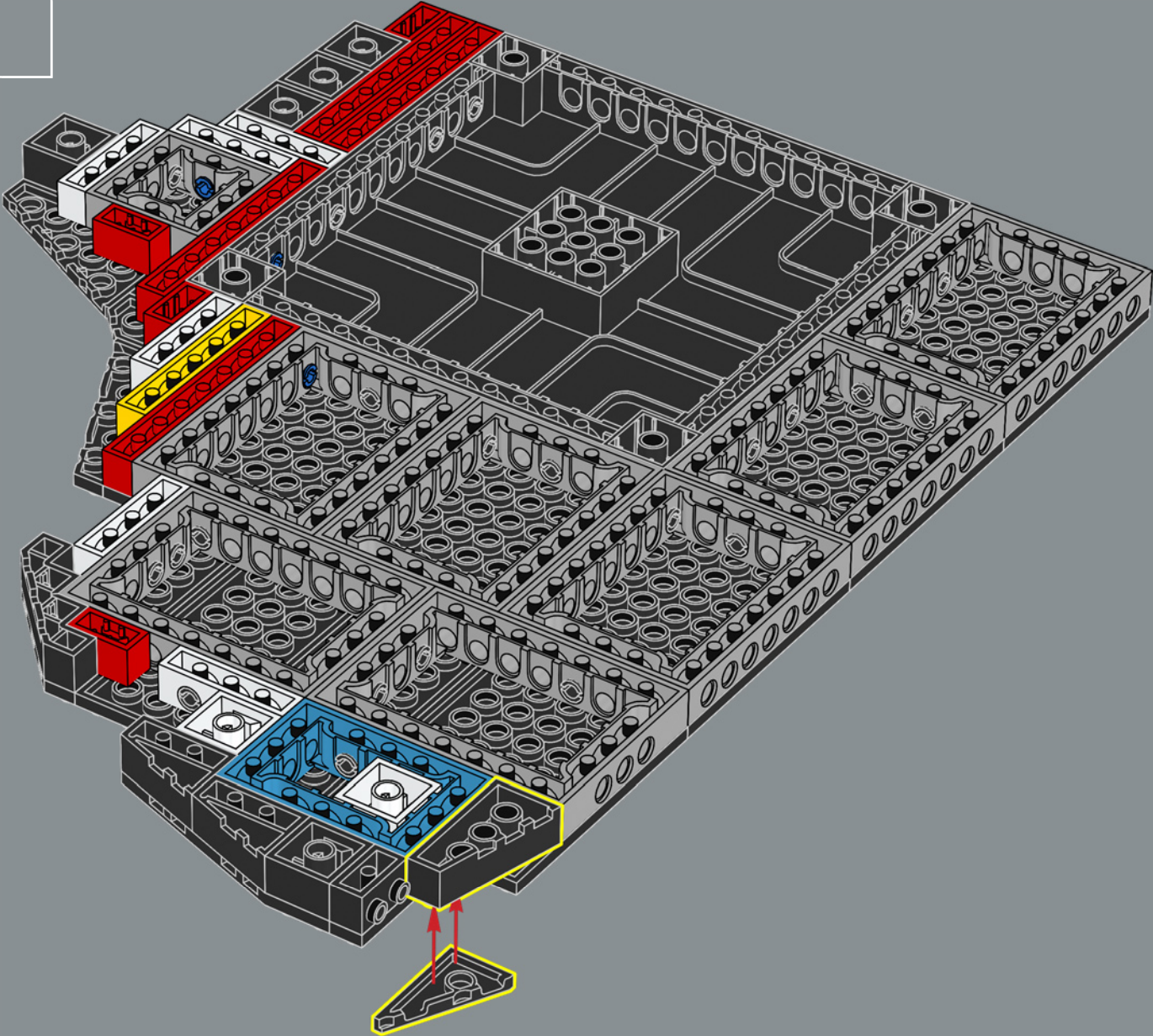

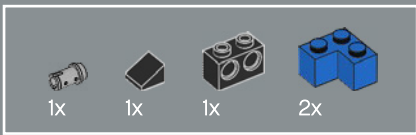

14

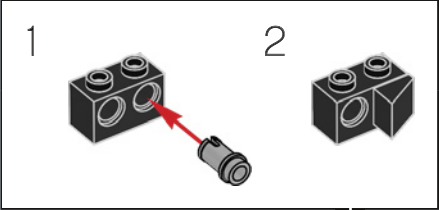
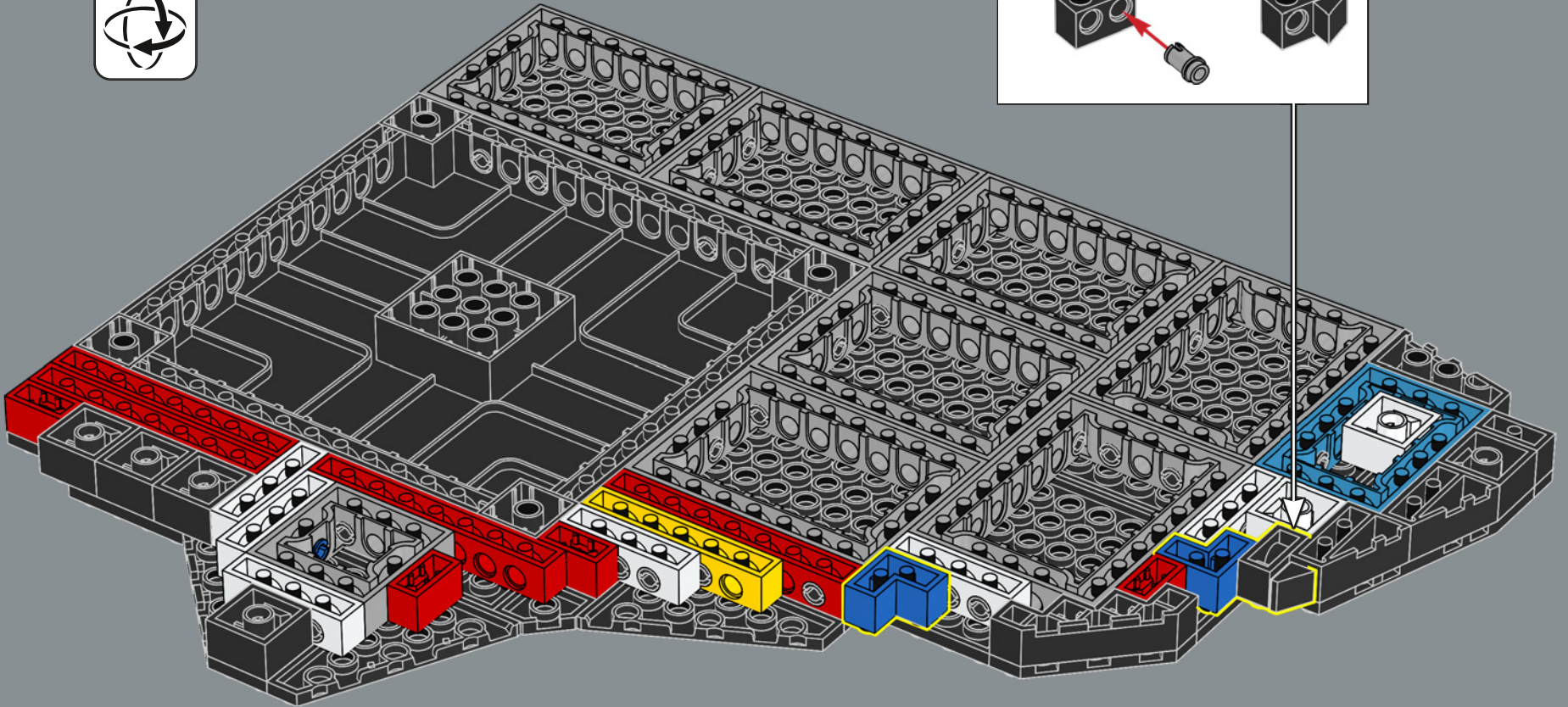

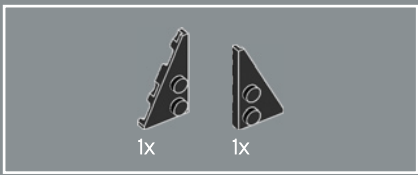

15

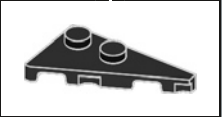
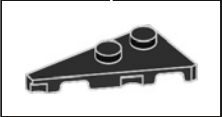
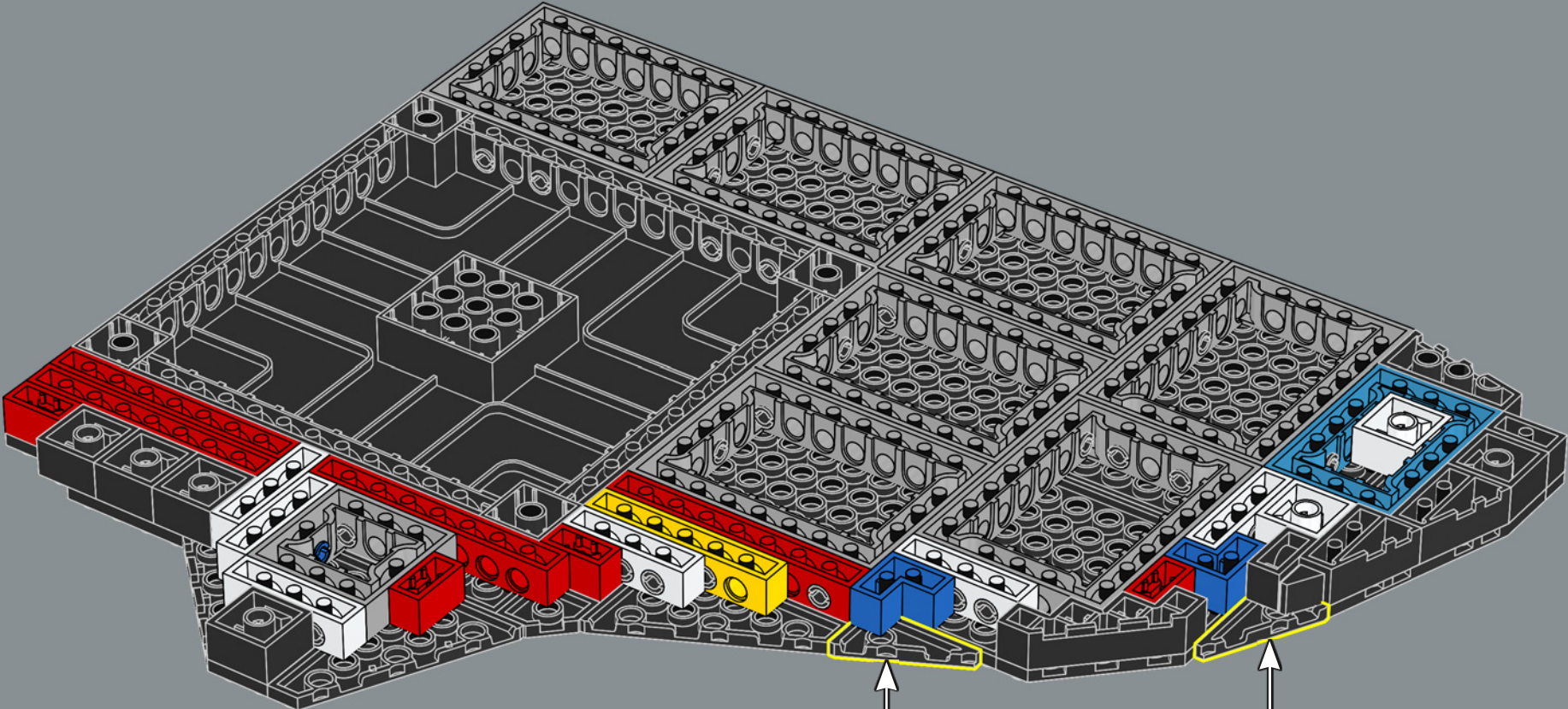

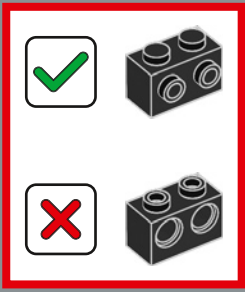
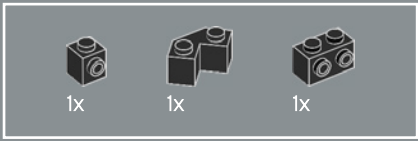

16

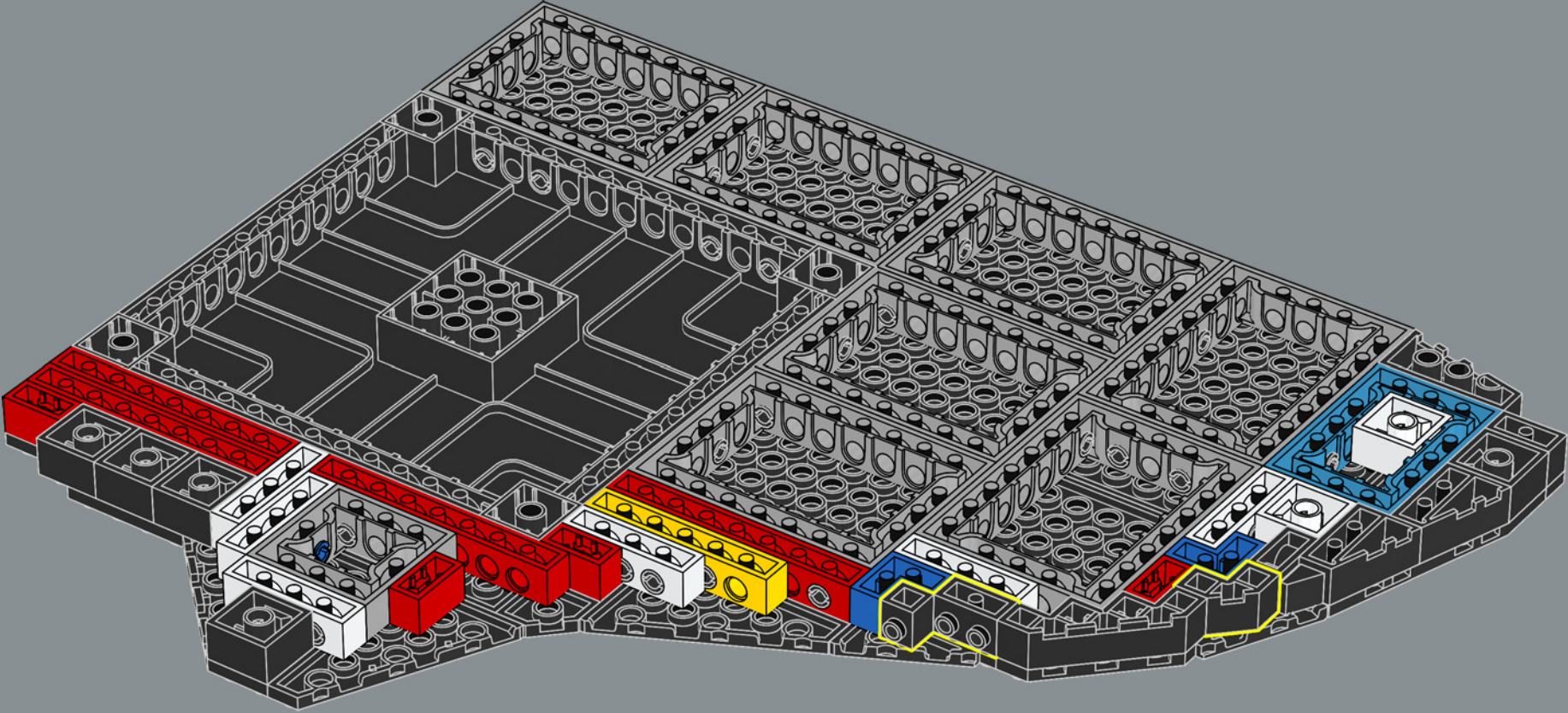

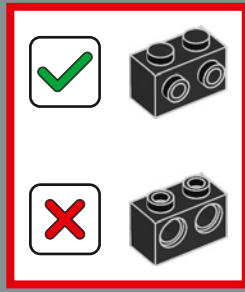
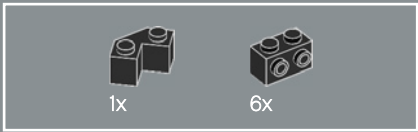

17

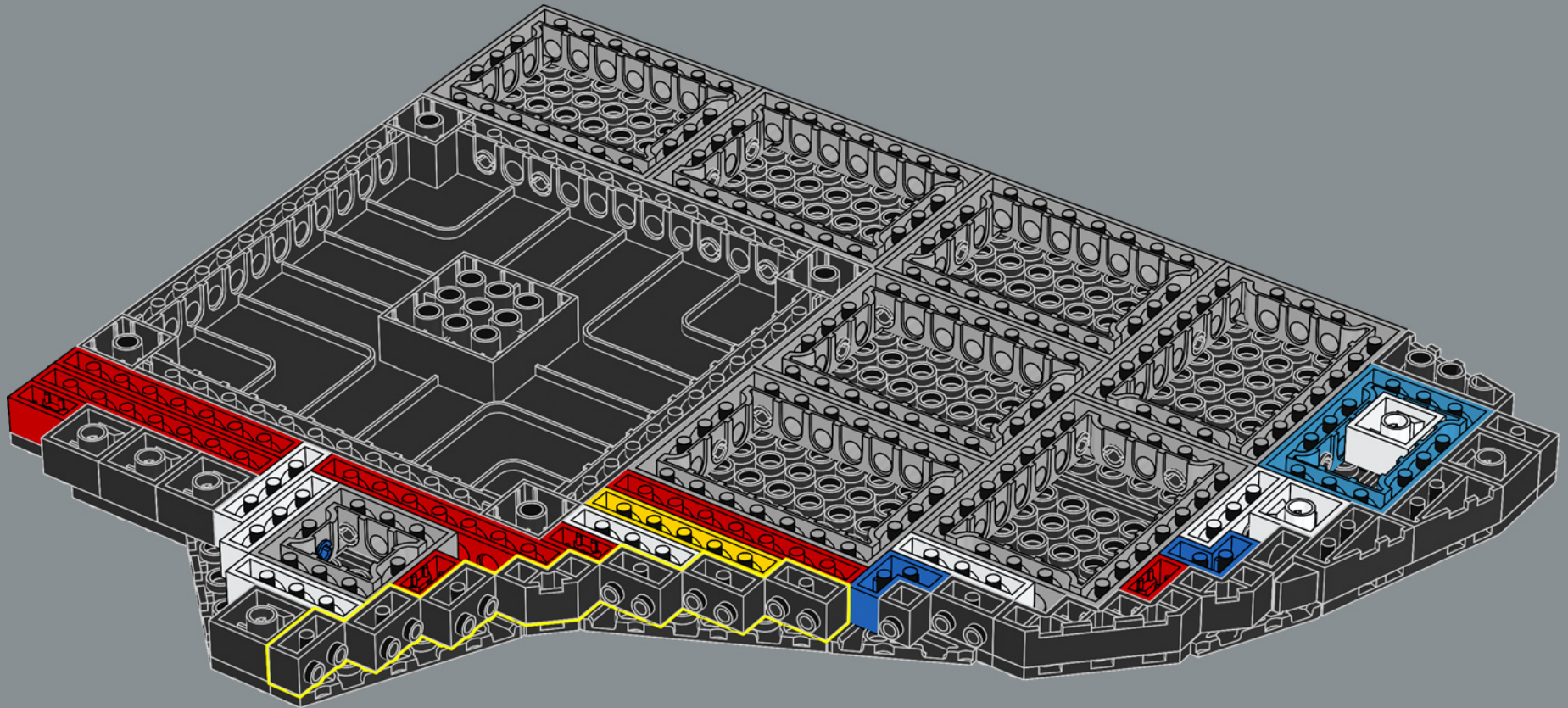



18

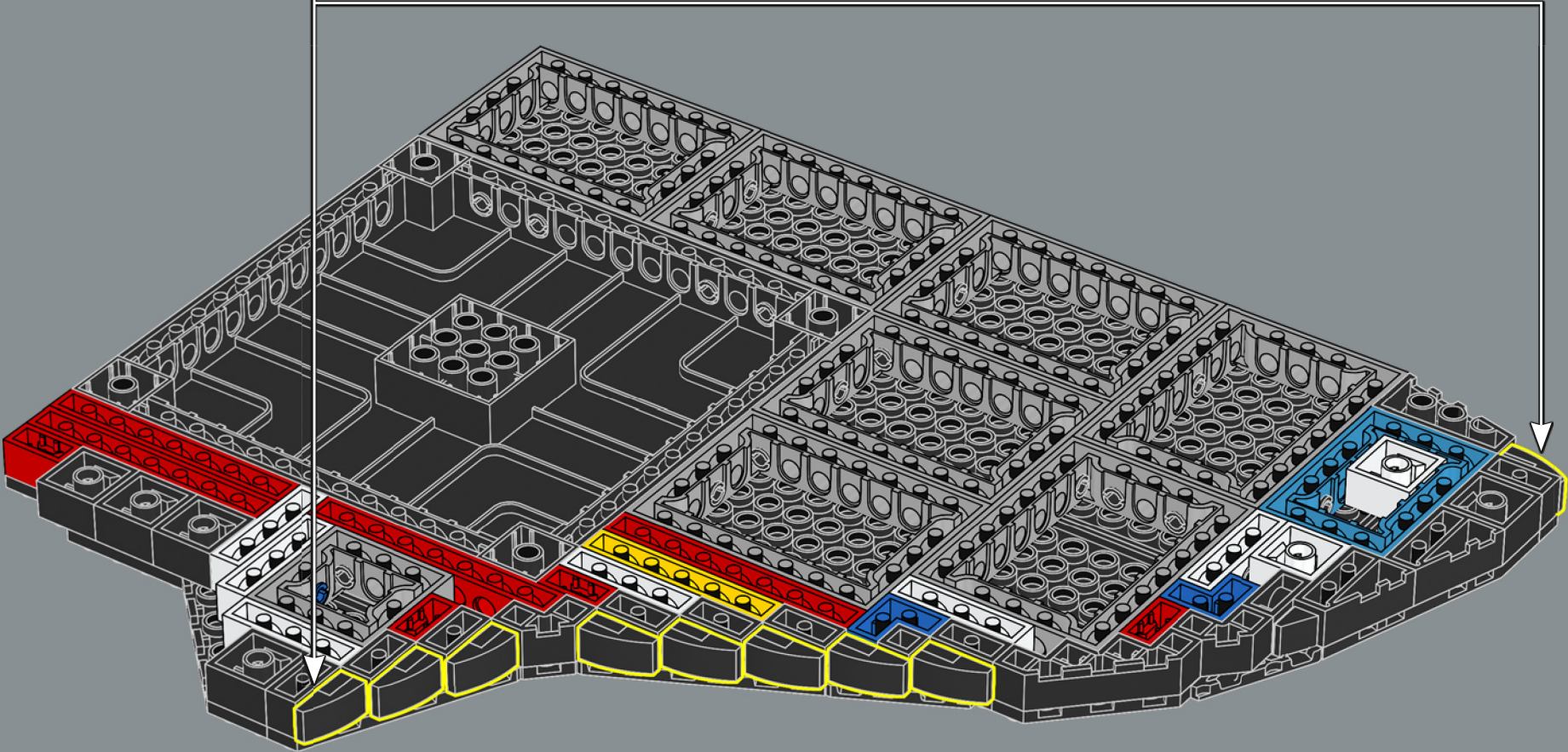
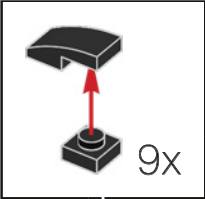

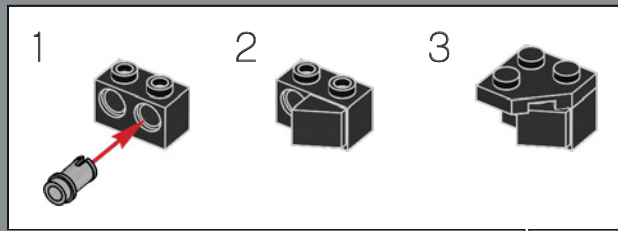
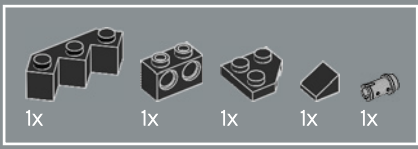

19

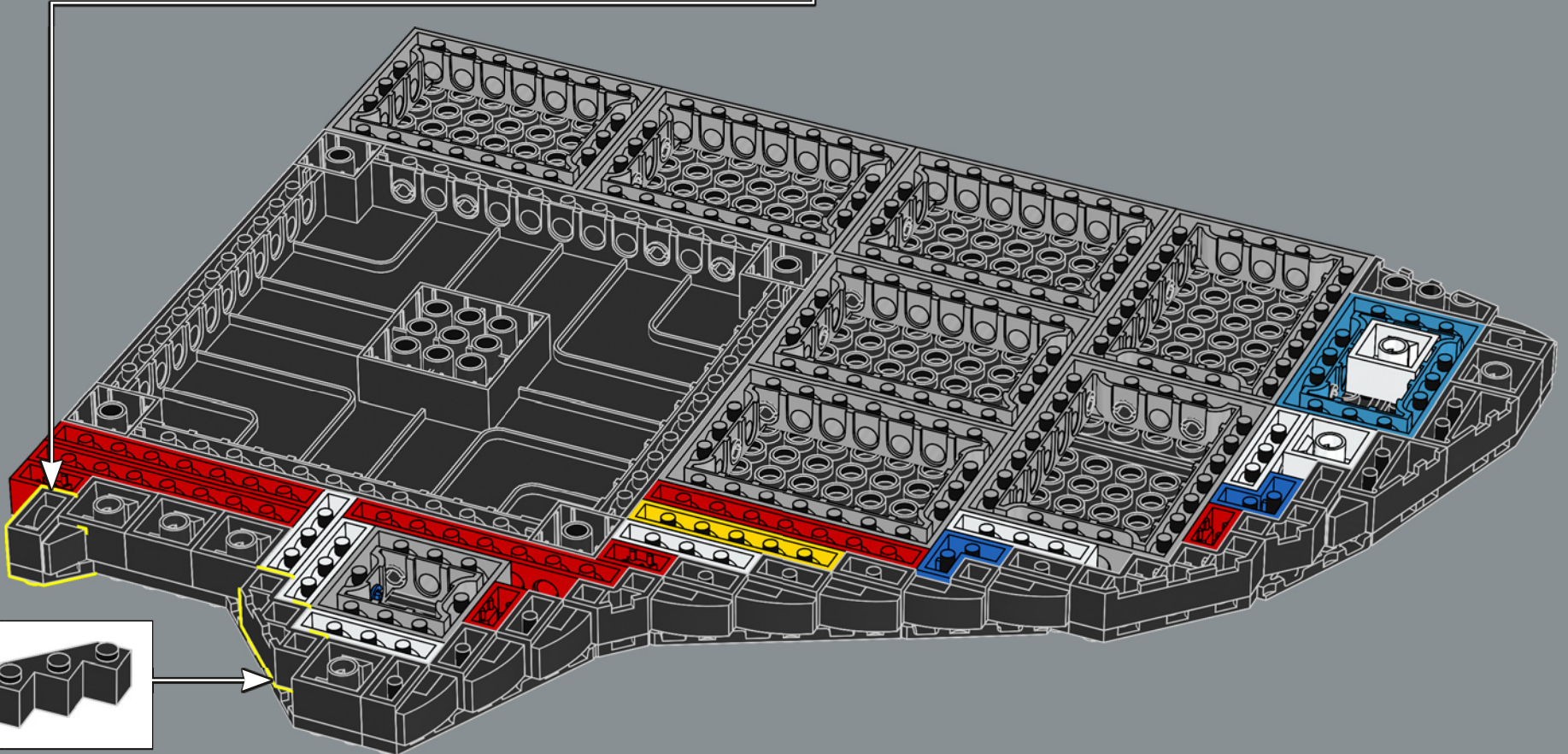

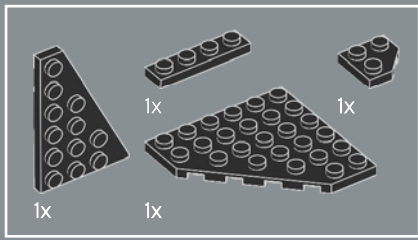

20

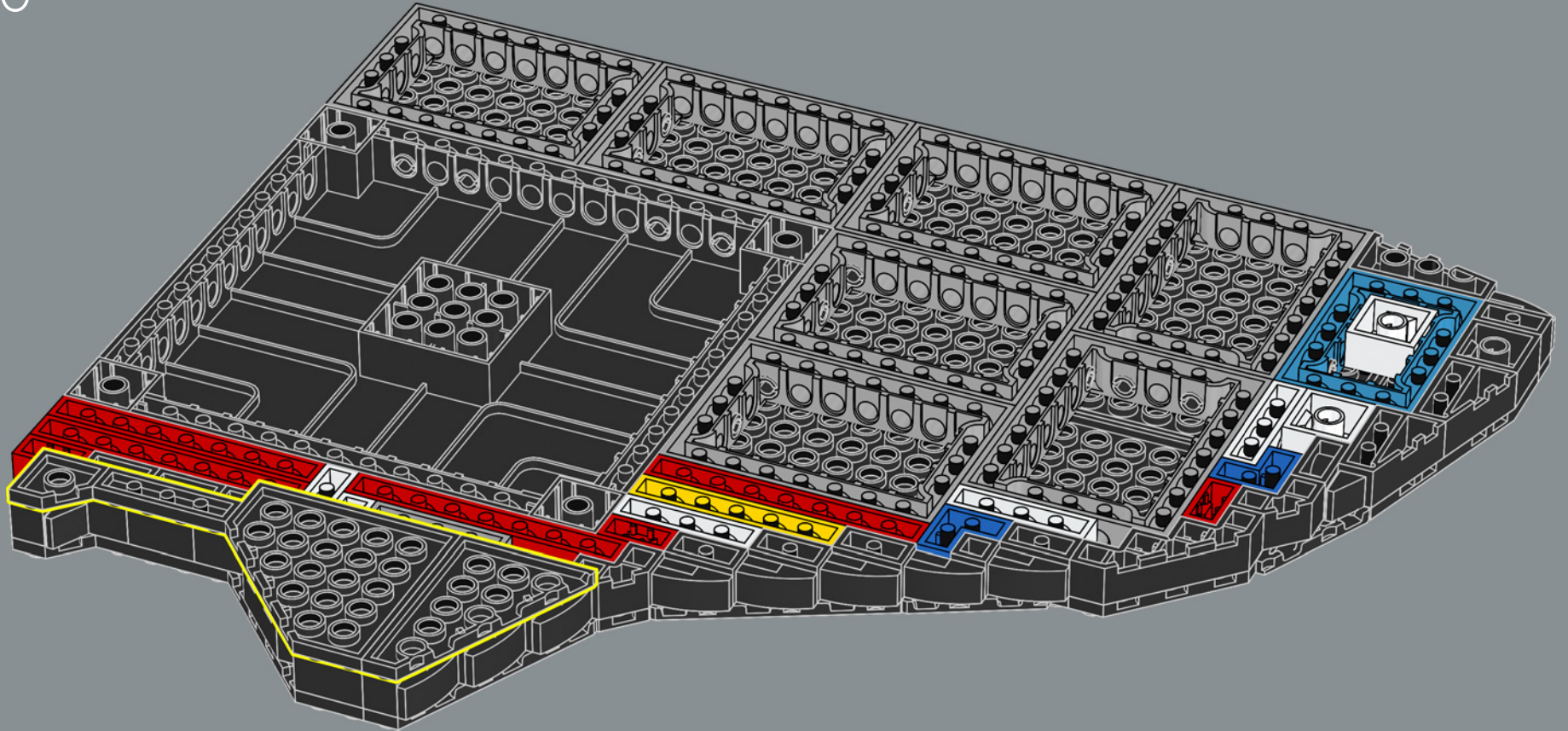

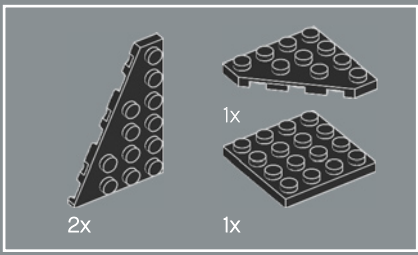

21

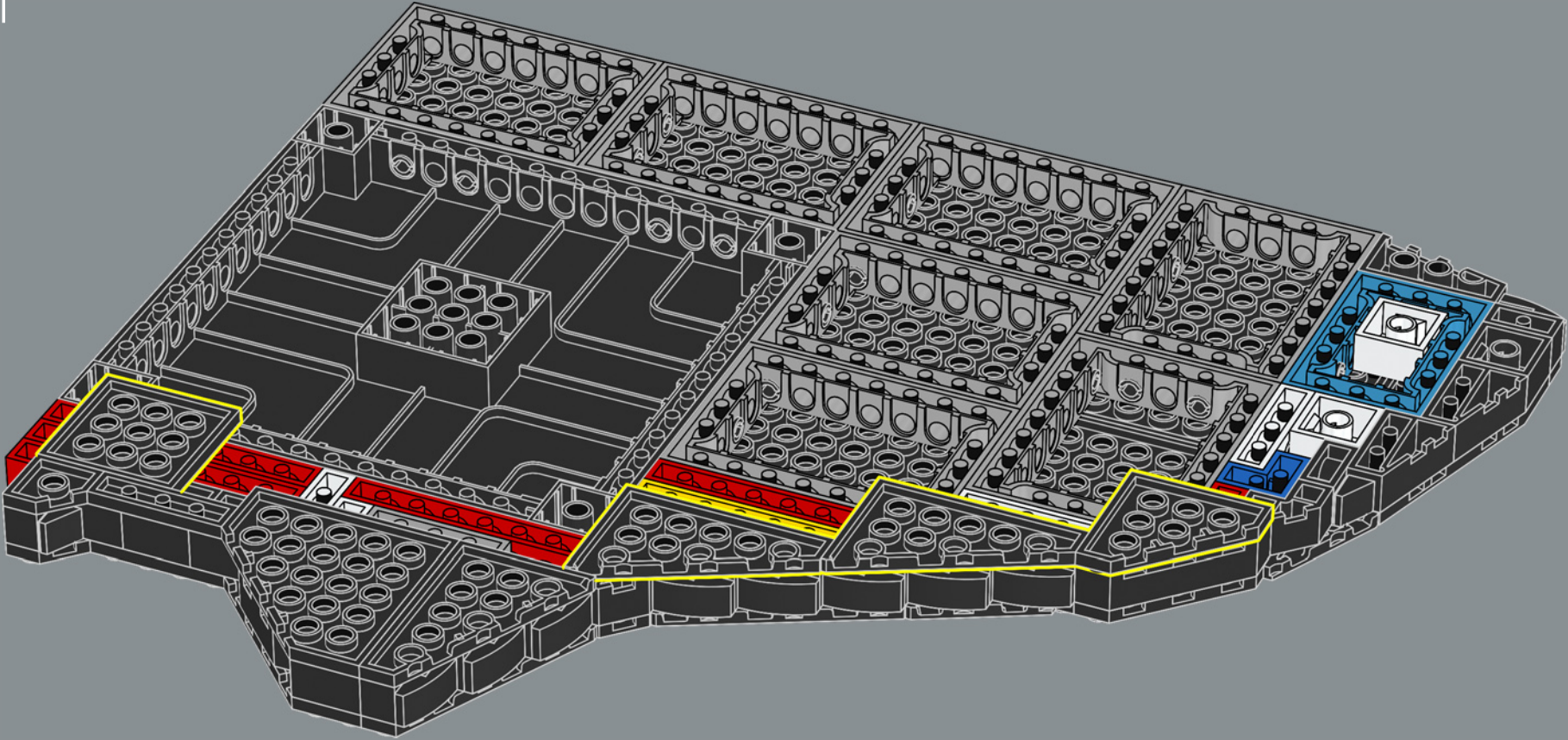

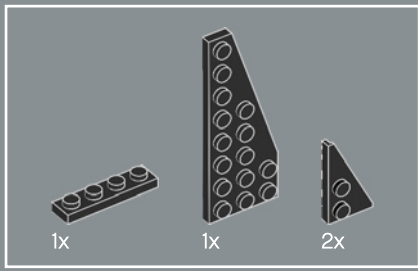

22

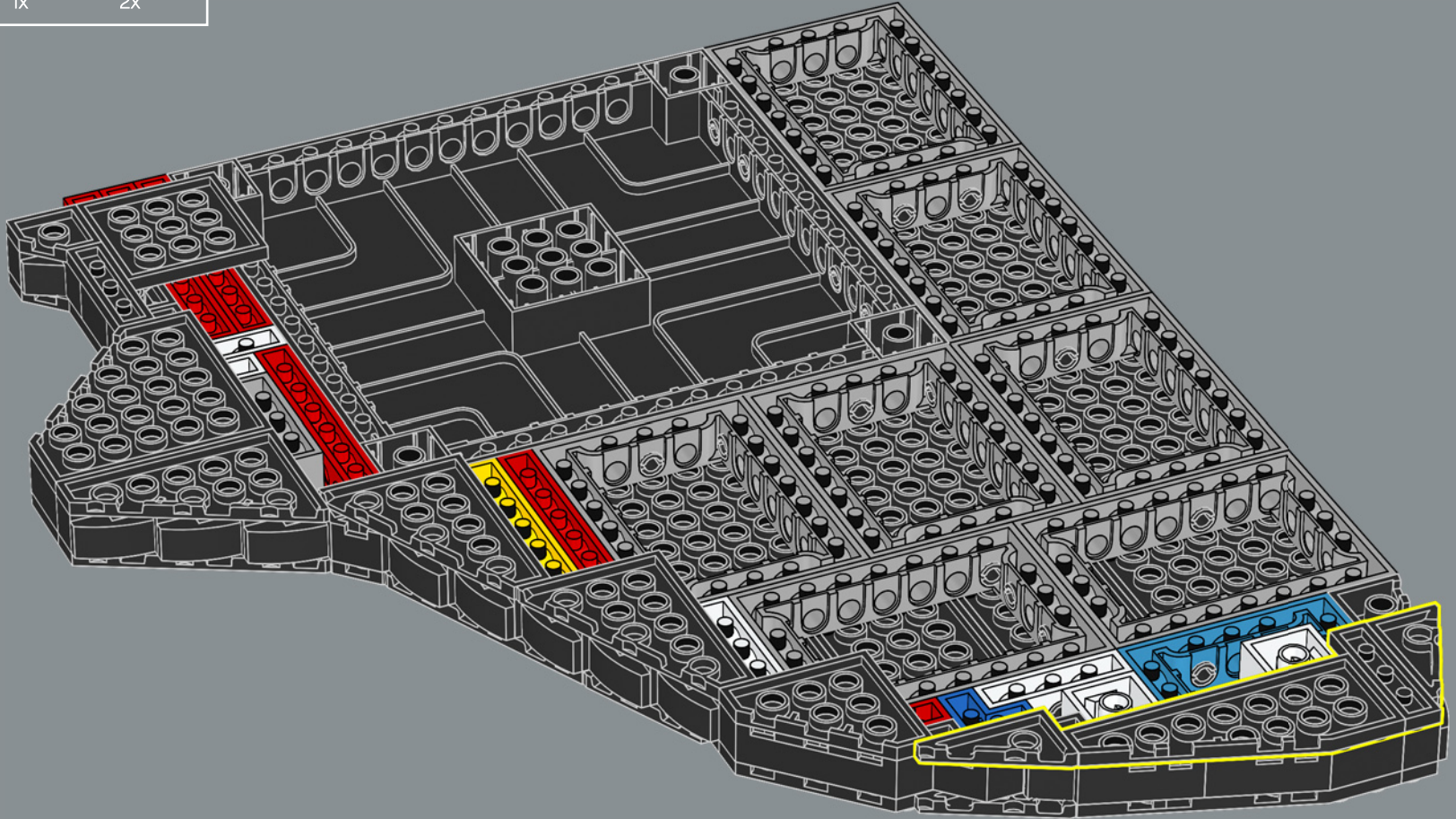

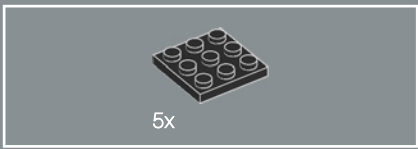

23

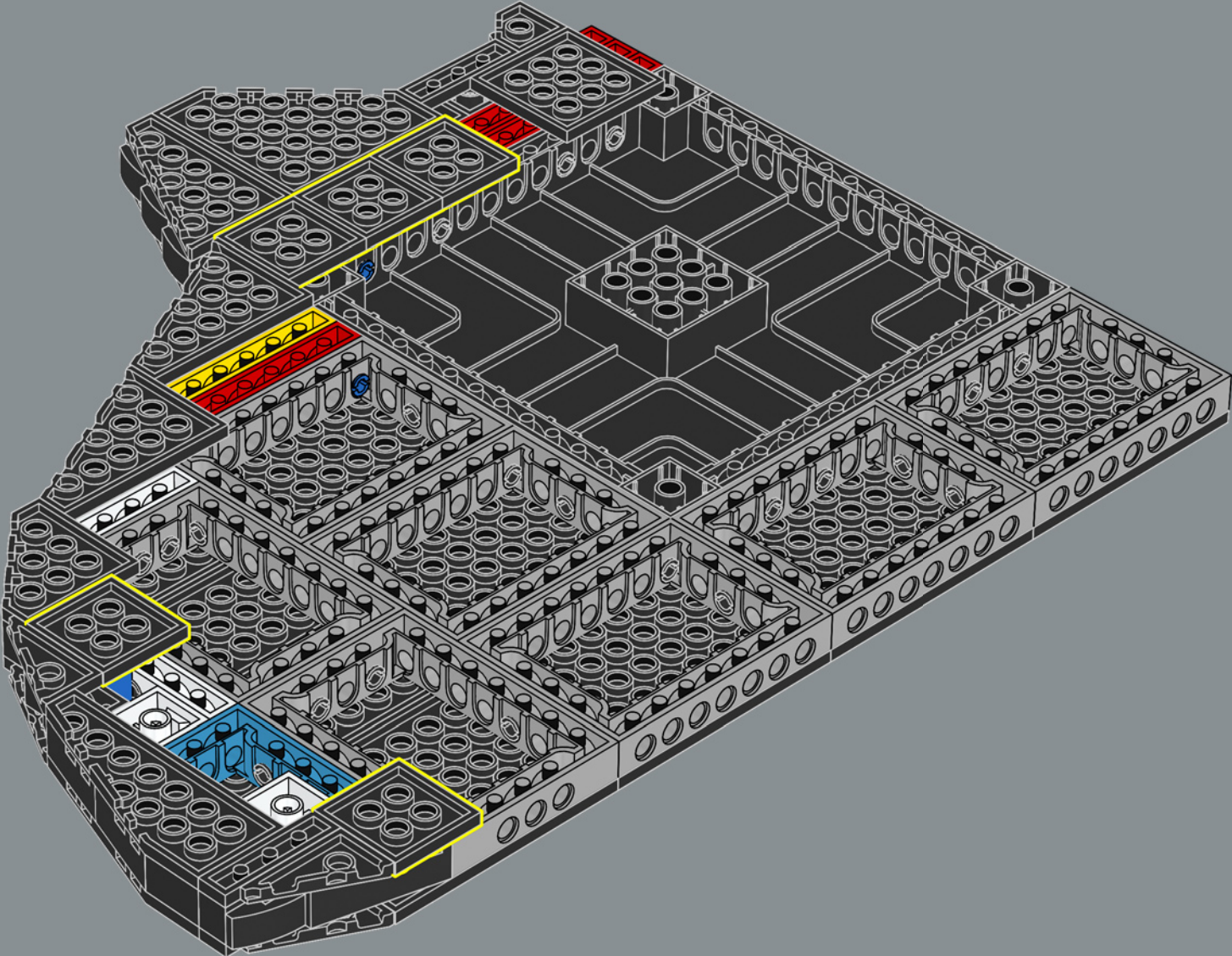

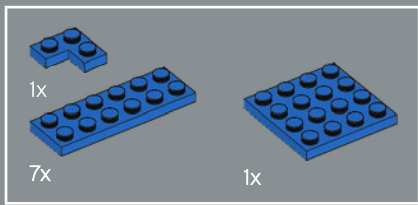

24

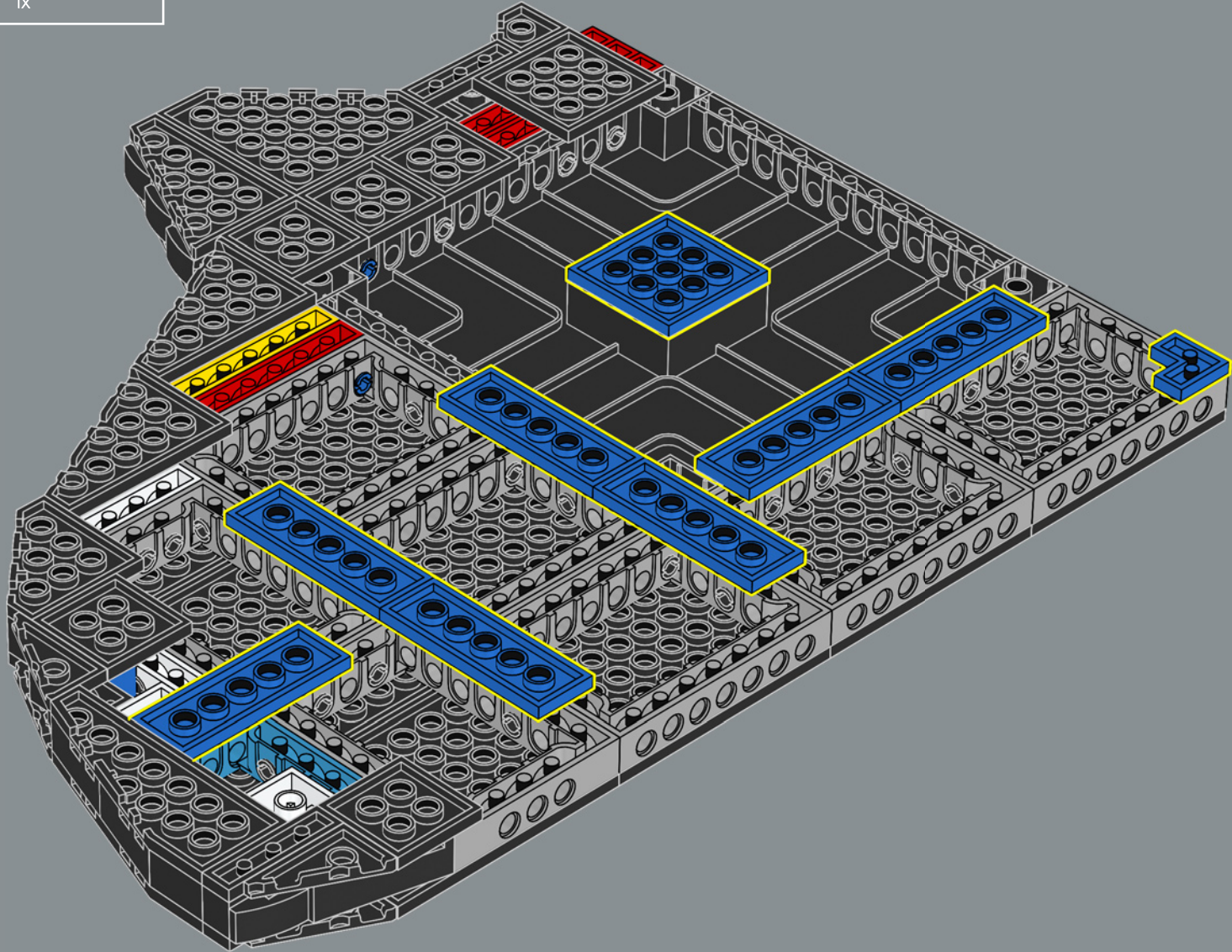

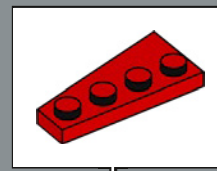
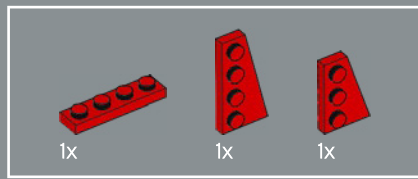

25

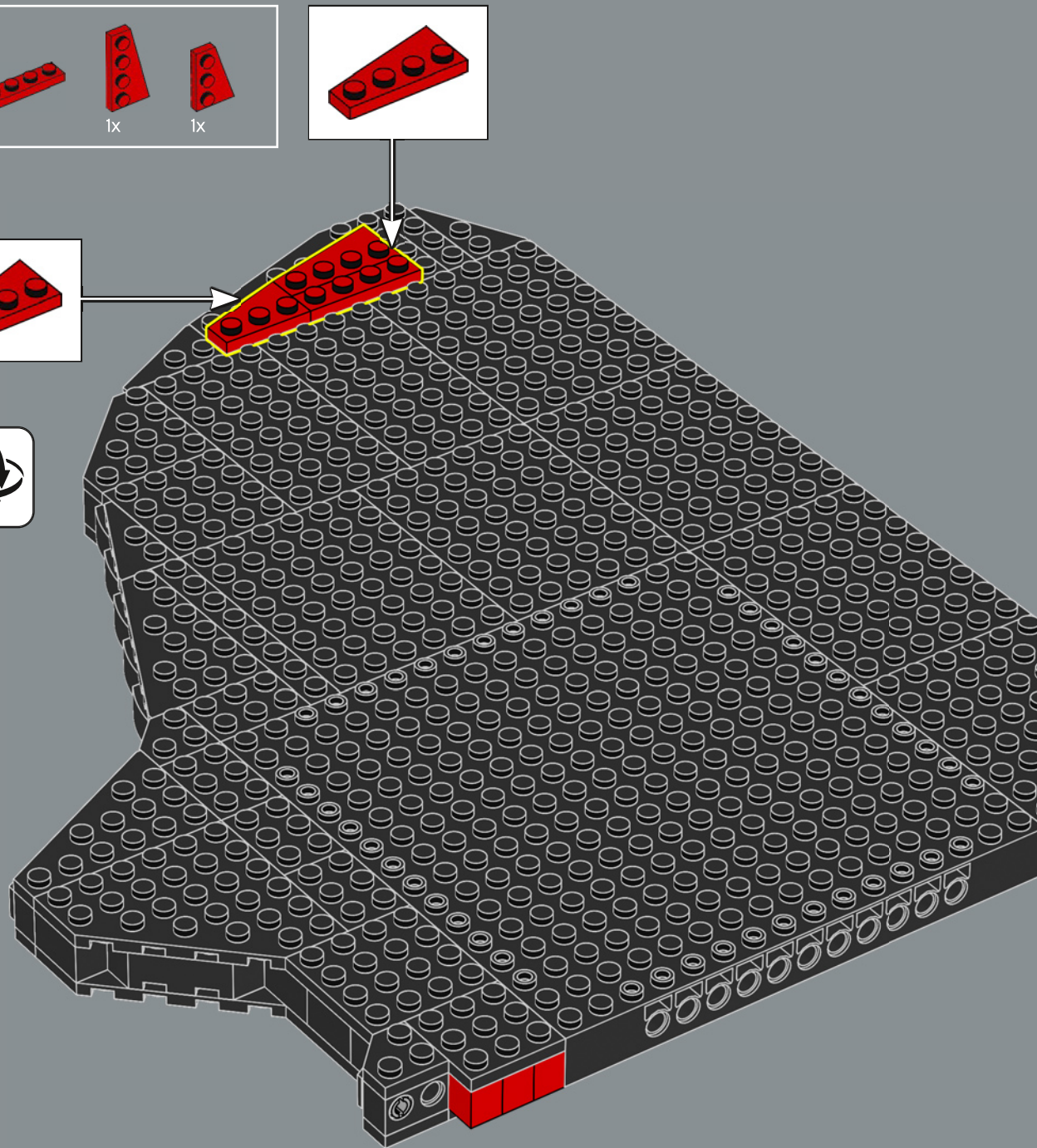
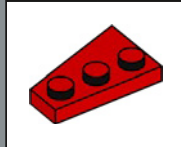

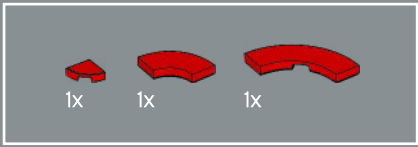

26

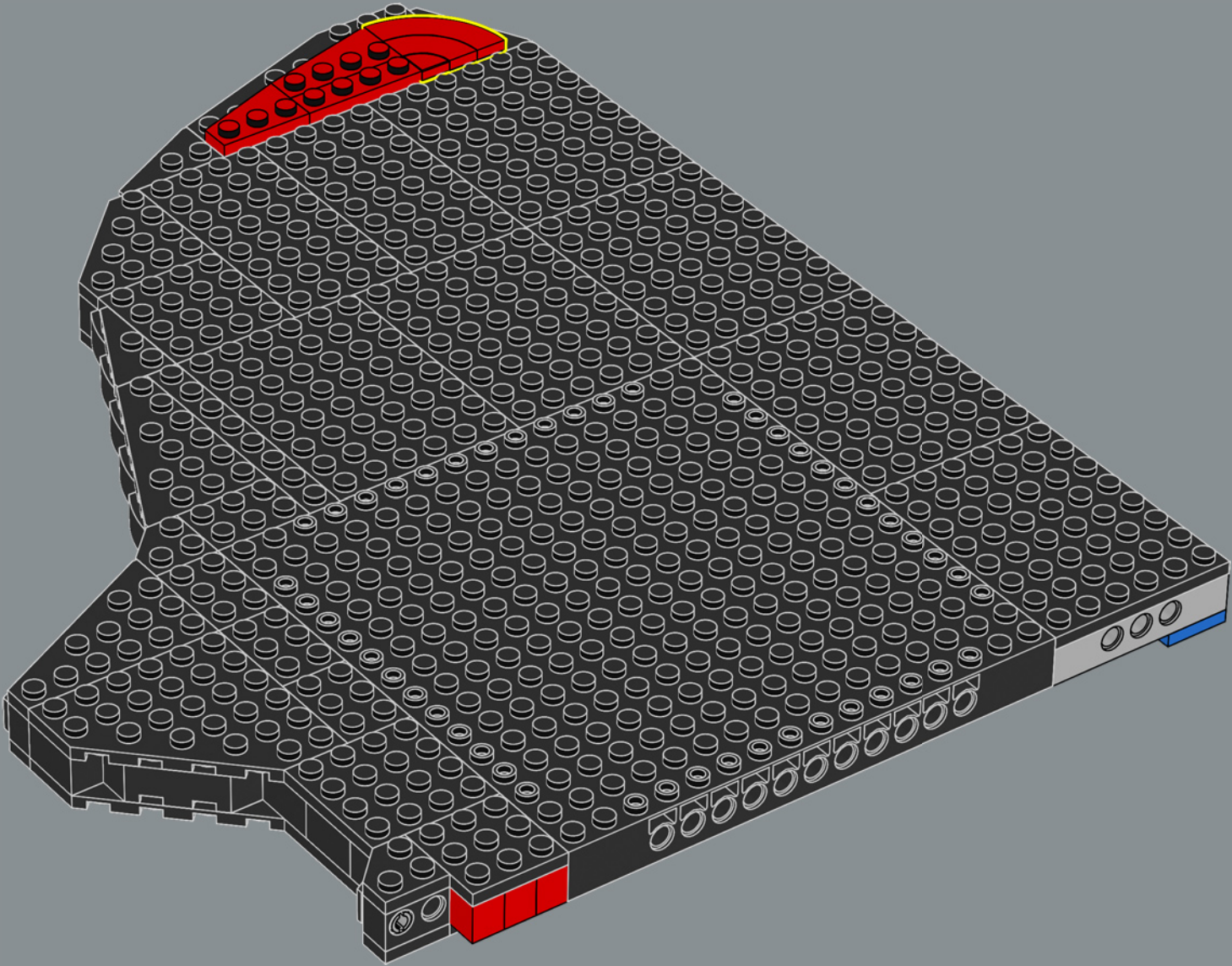

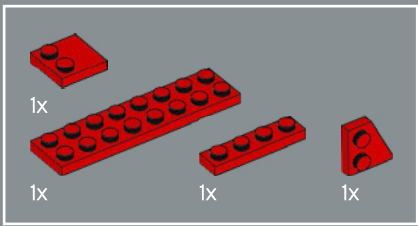

27

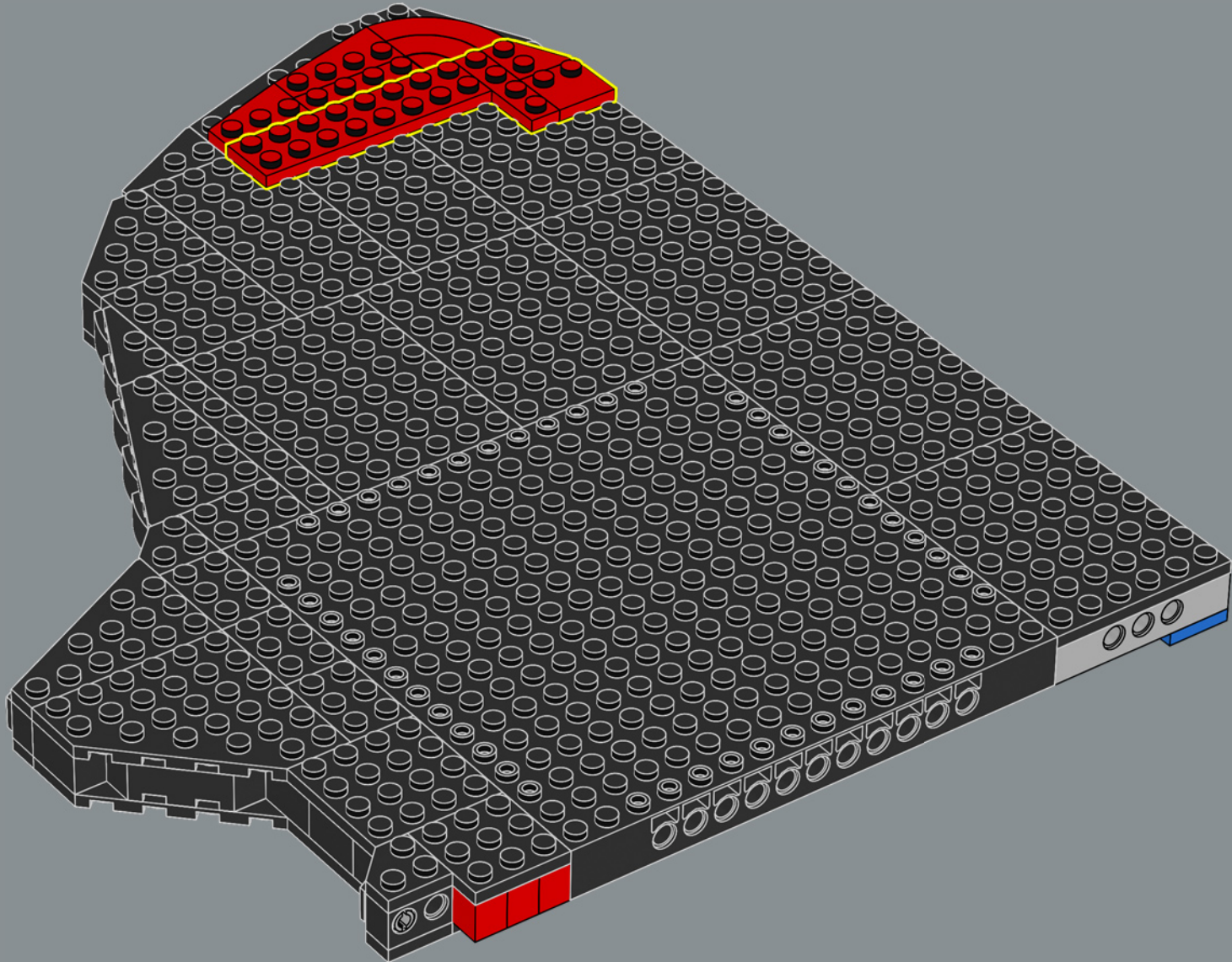

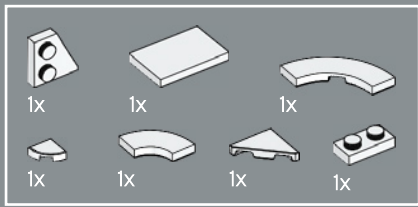

28

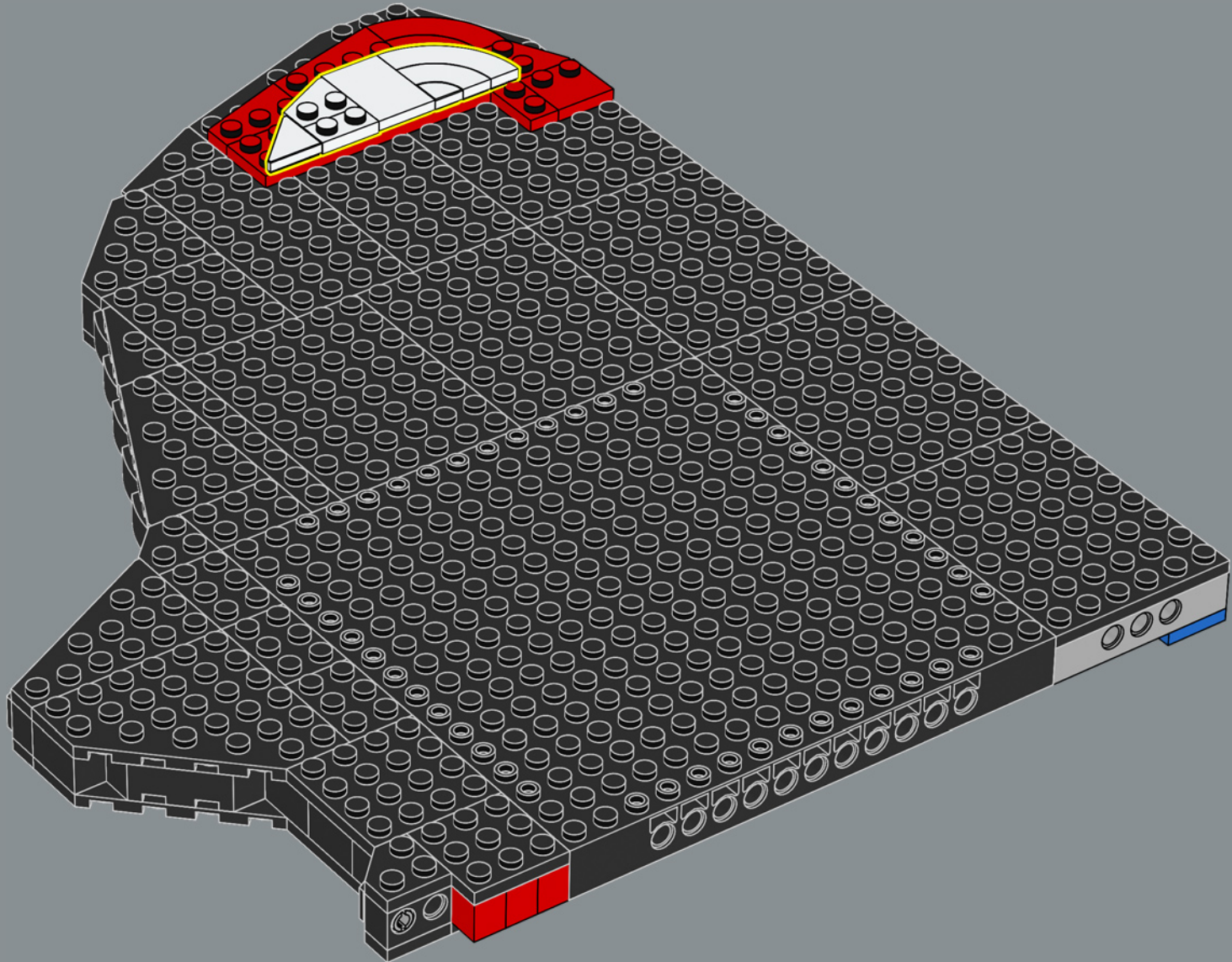

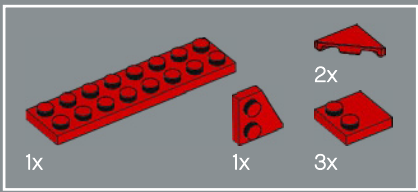

29

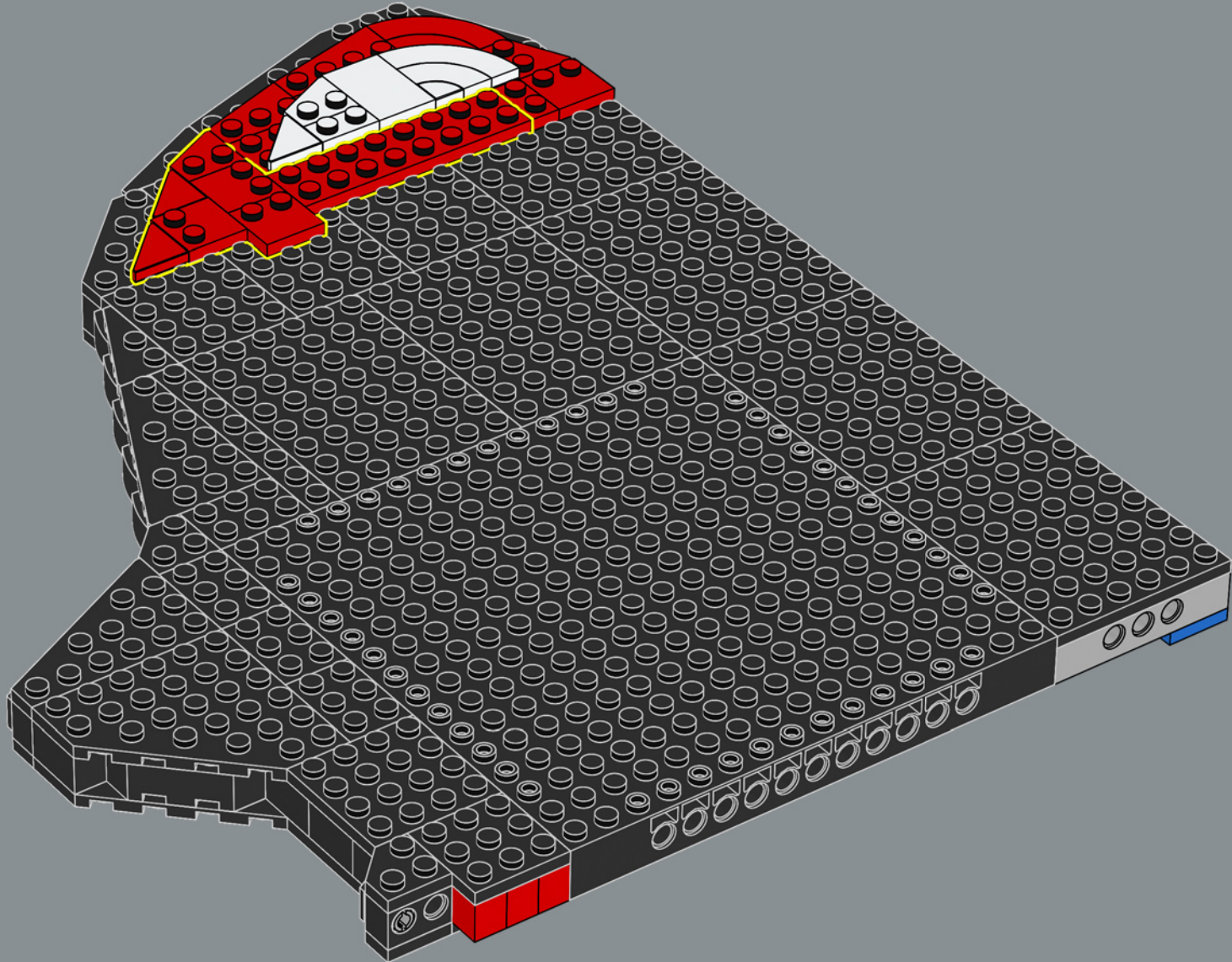

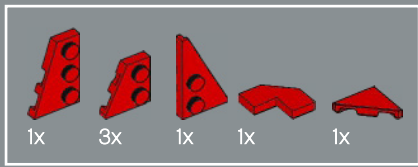

30

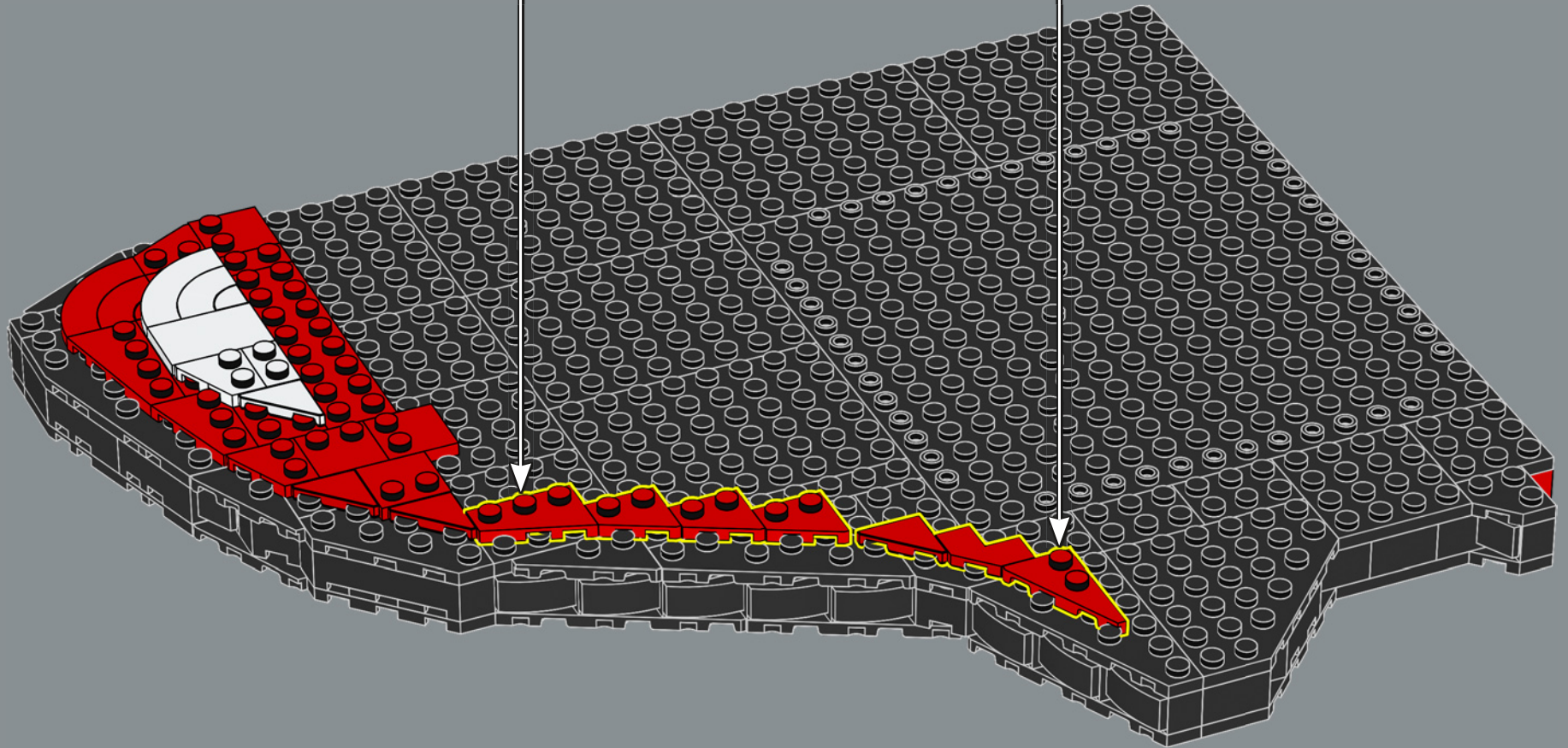
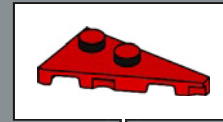
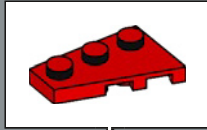

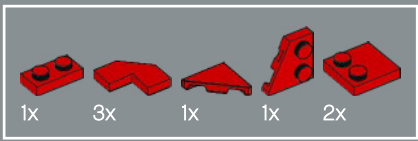

31

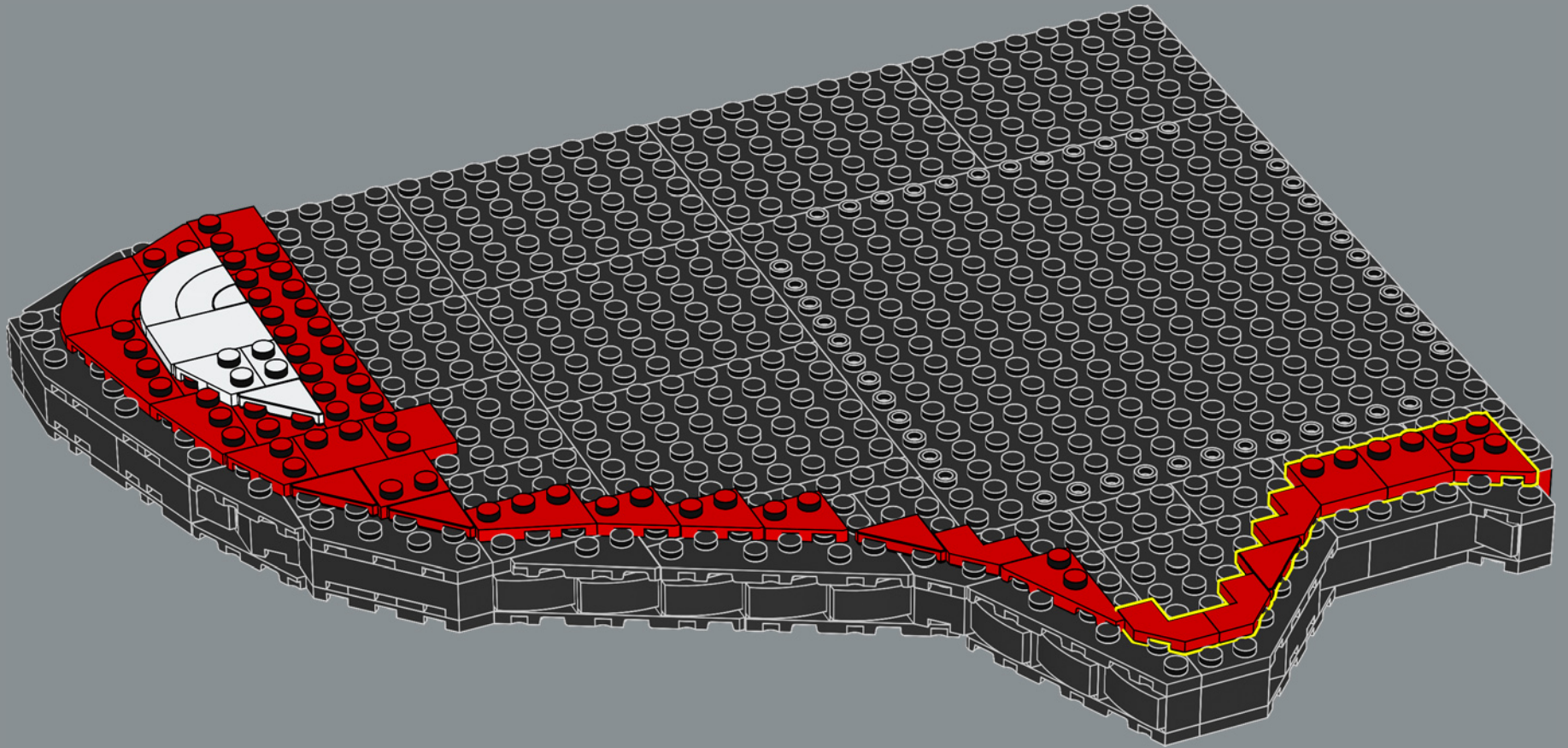

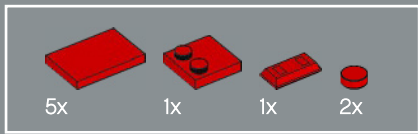

32

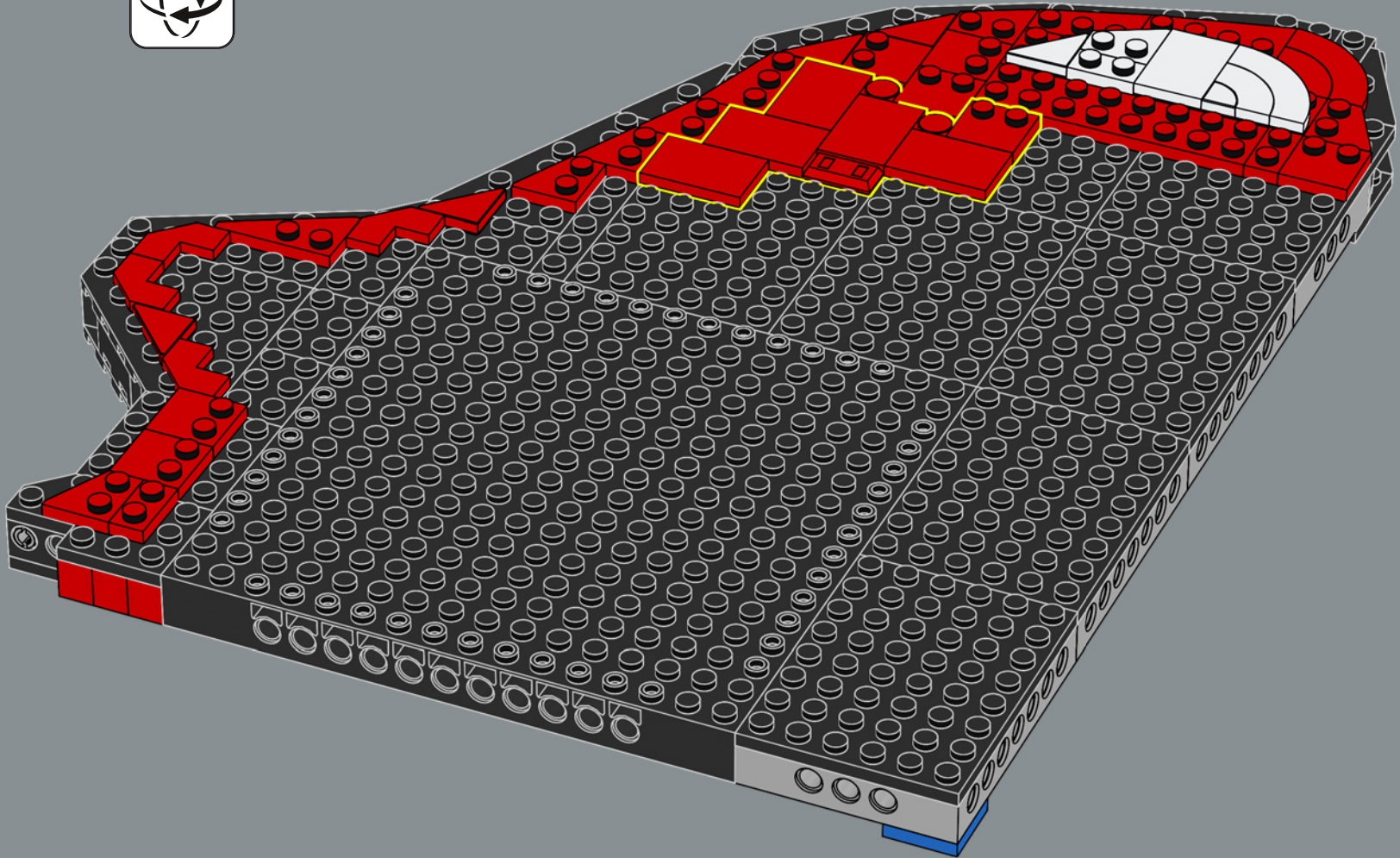

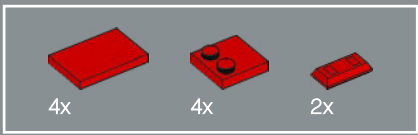

33

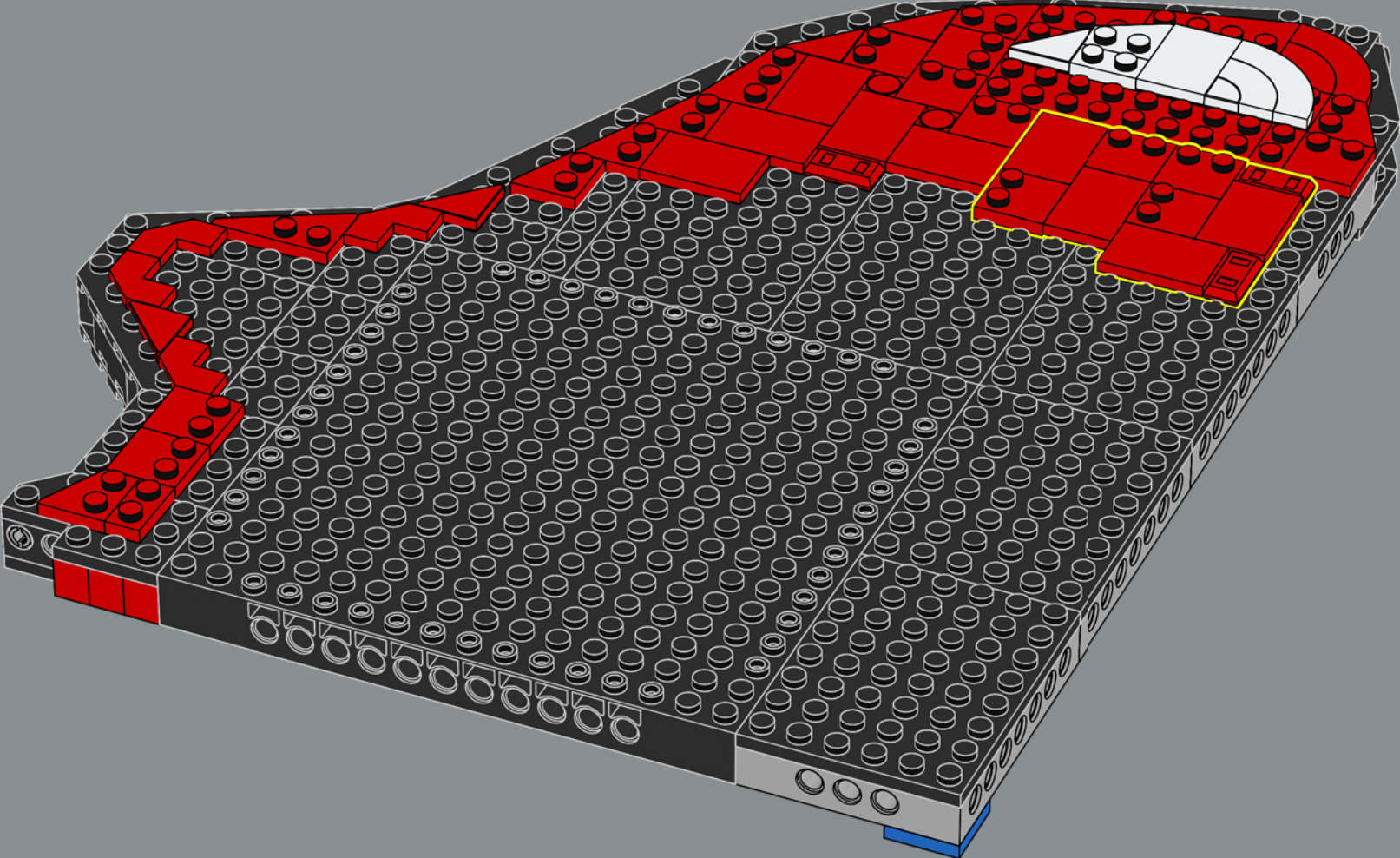

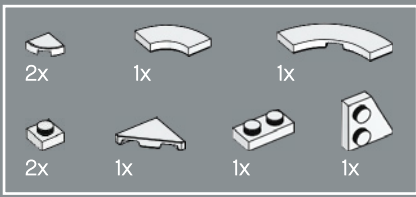

34

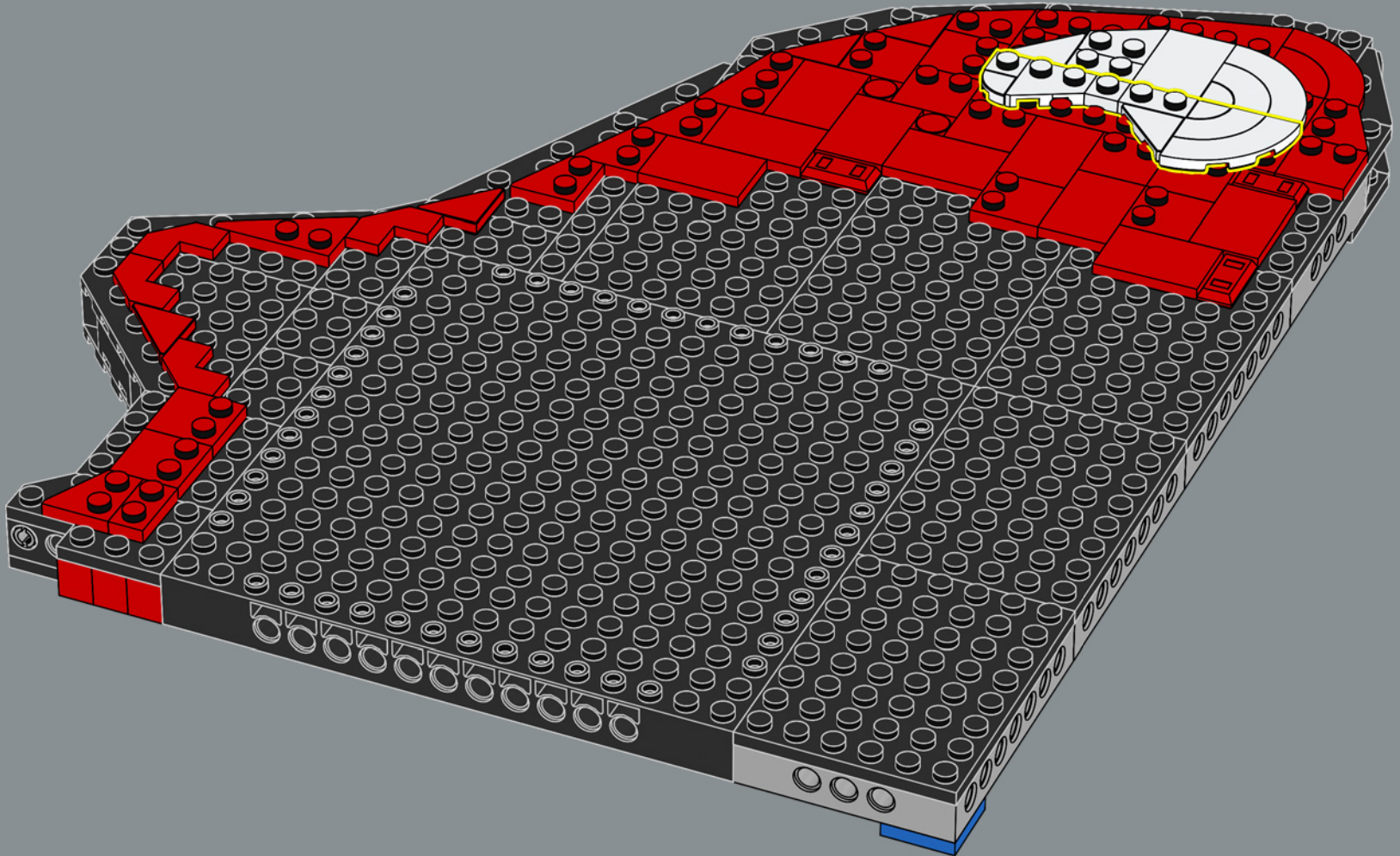

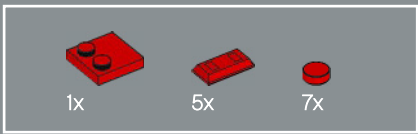

35

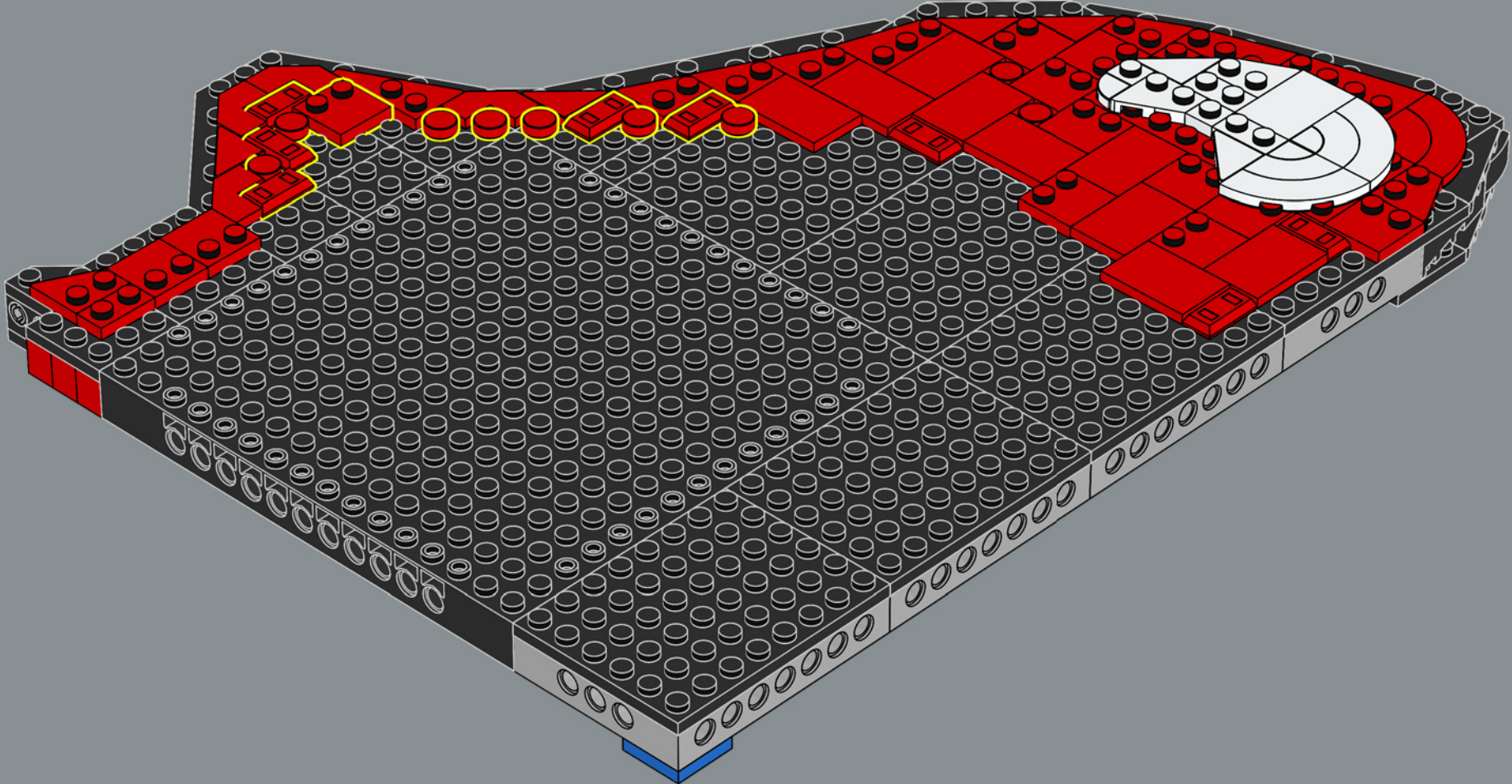

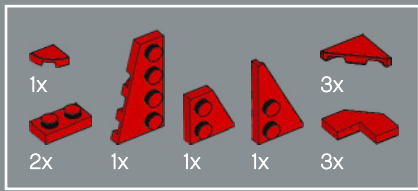

36

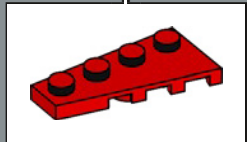
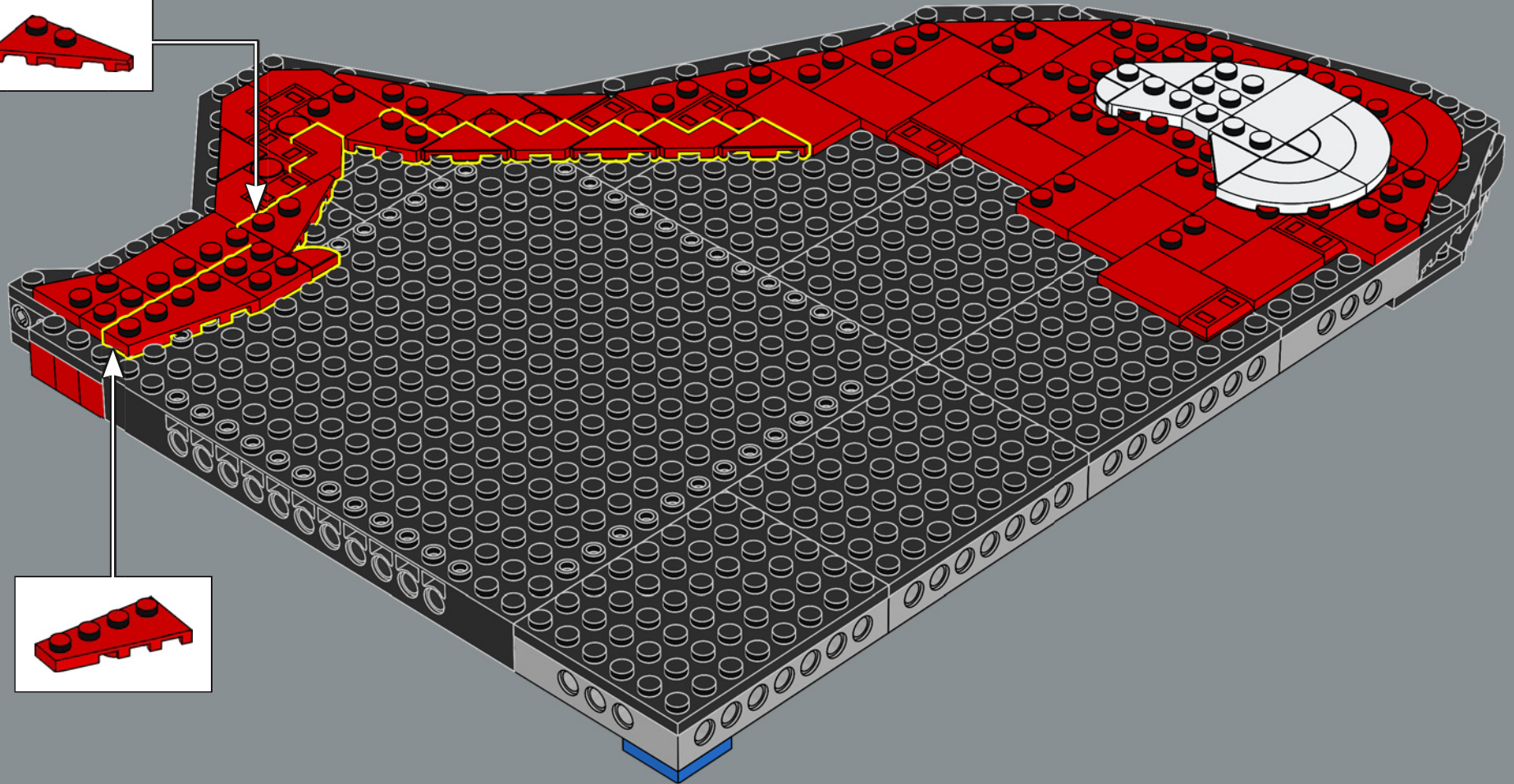
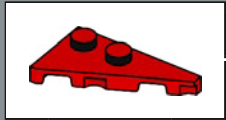

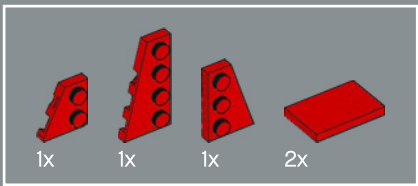

37

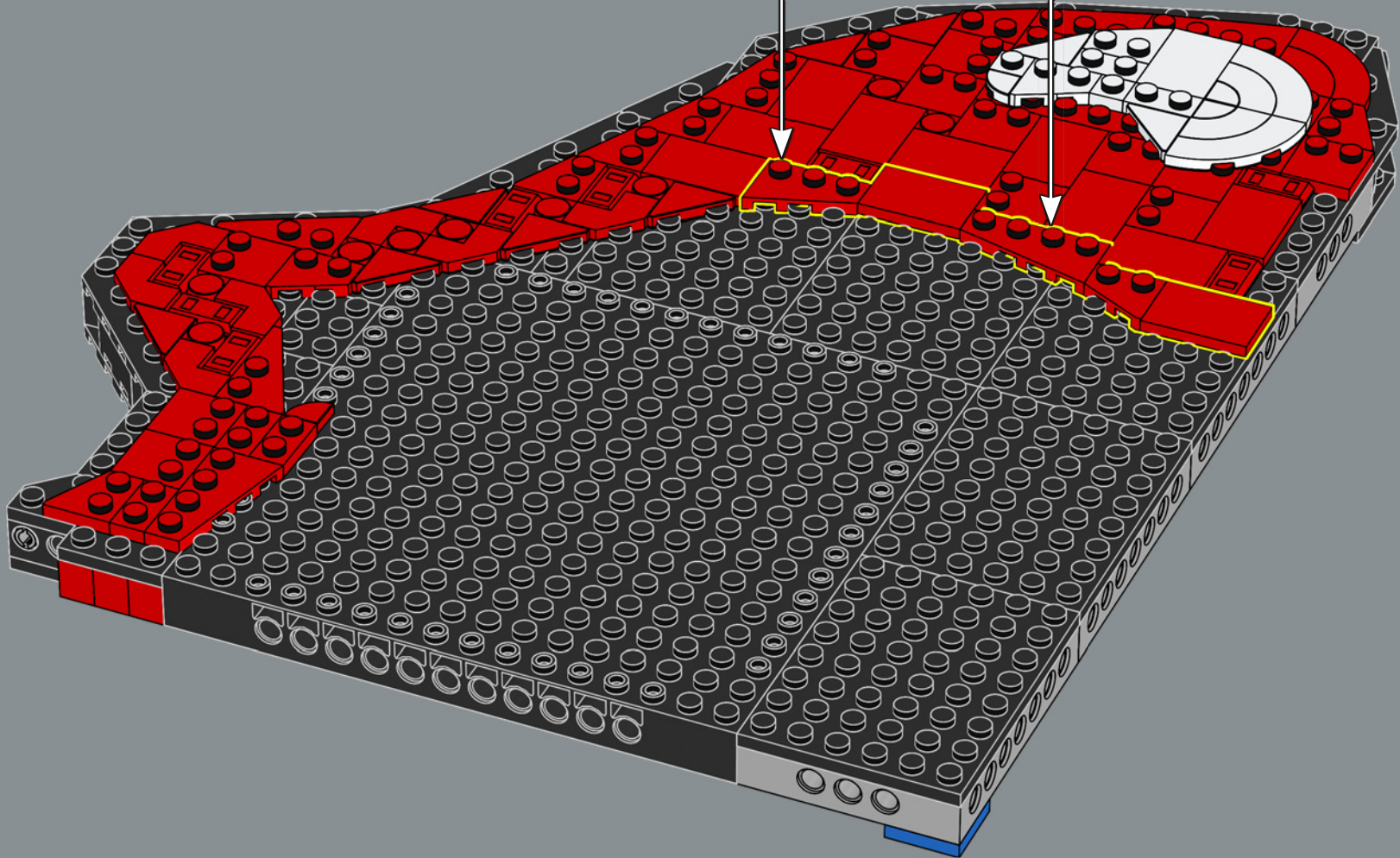
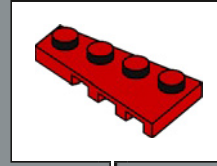

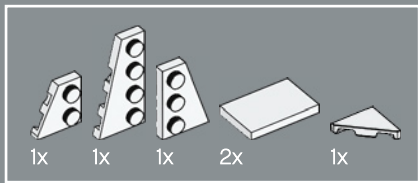

38

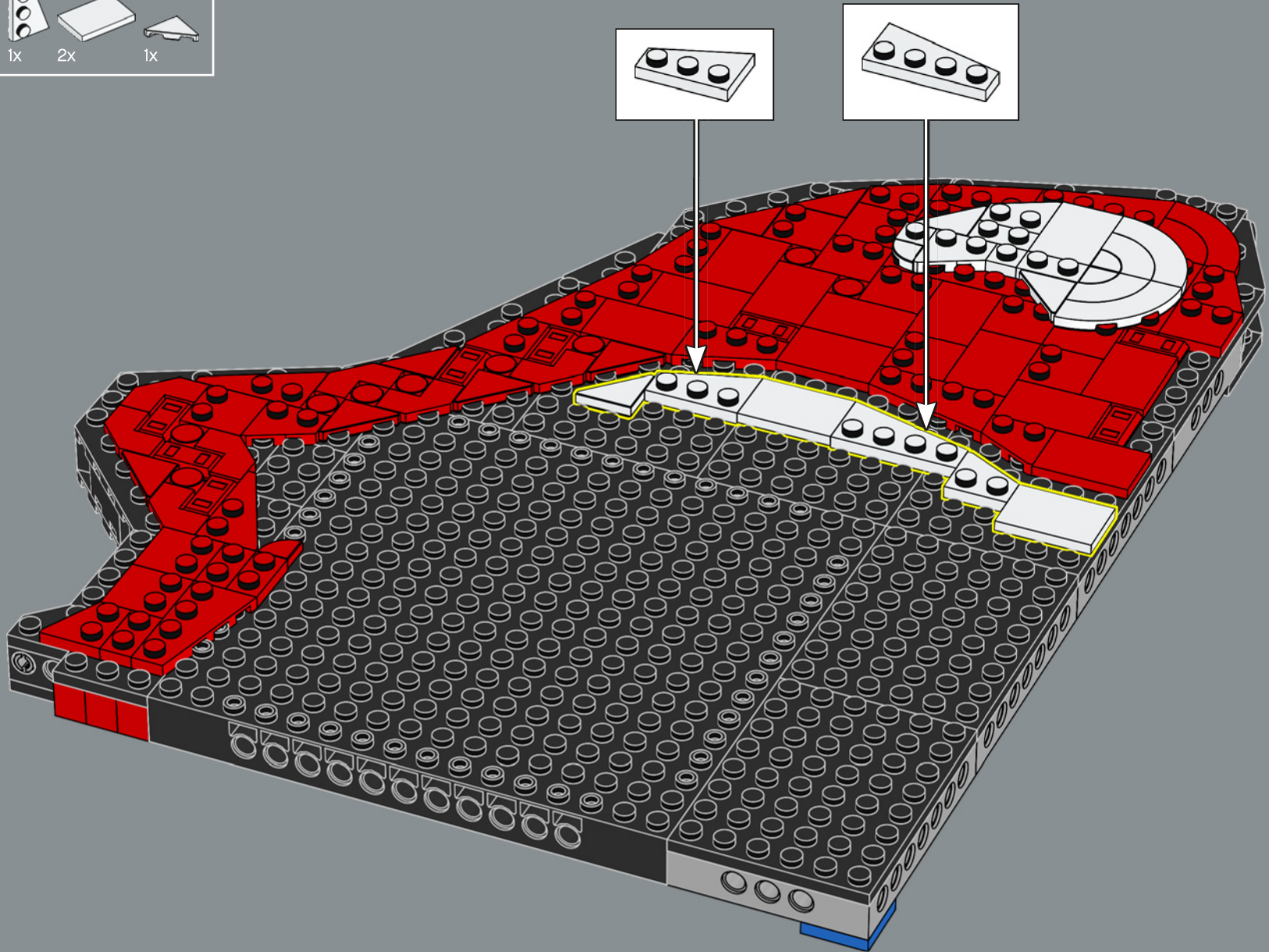

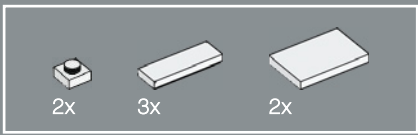

39

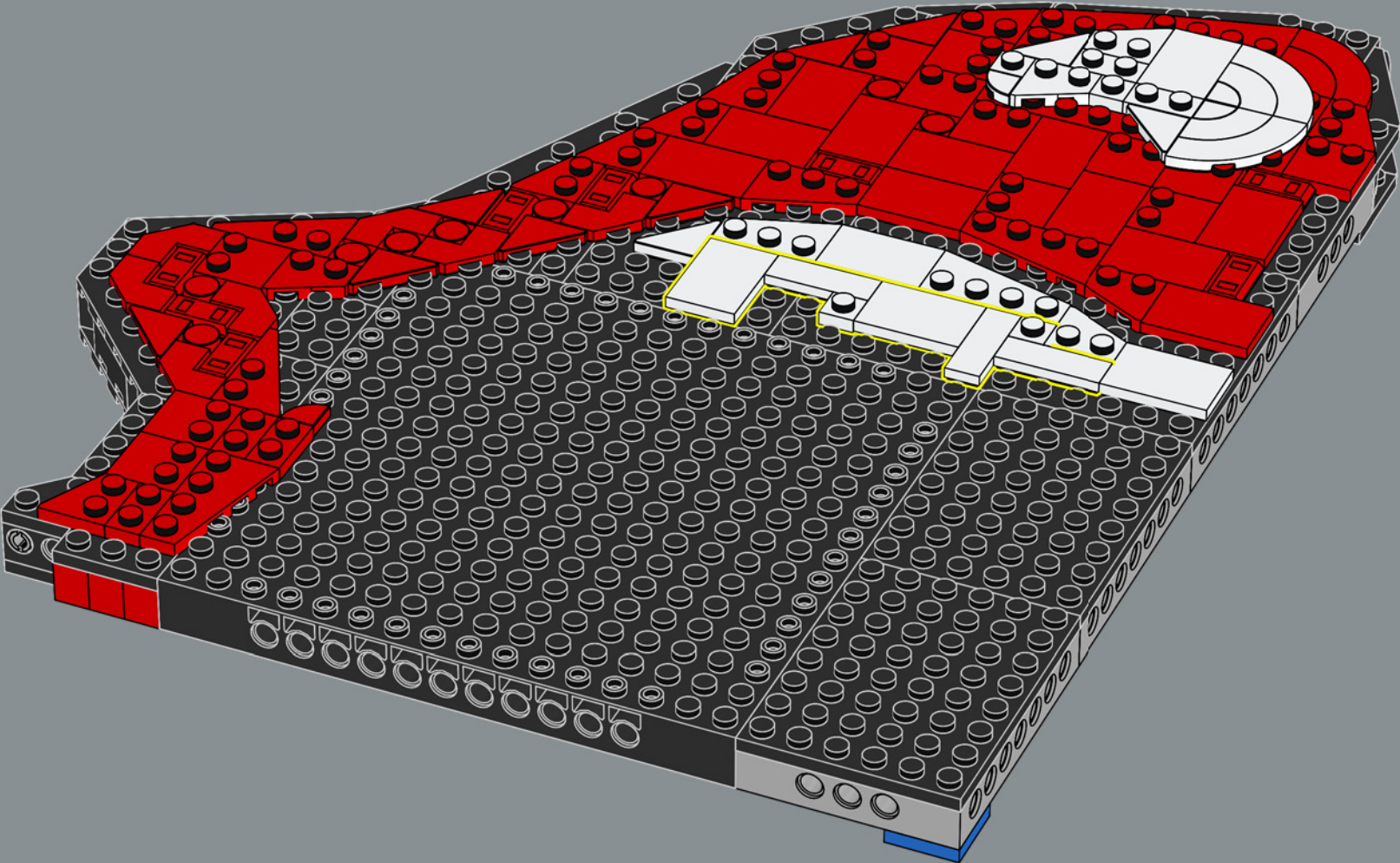

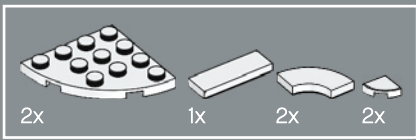

40

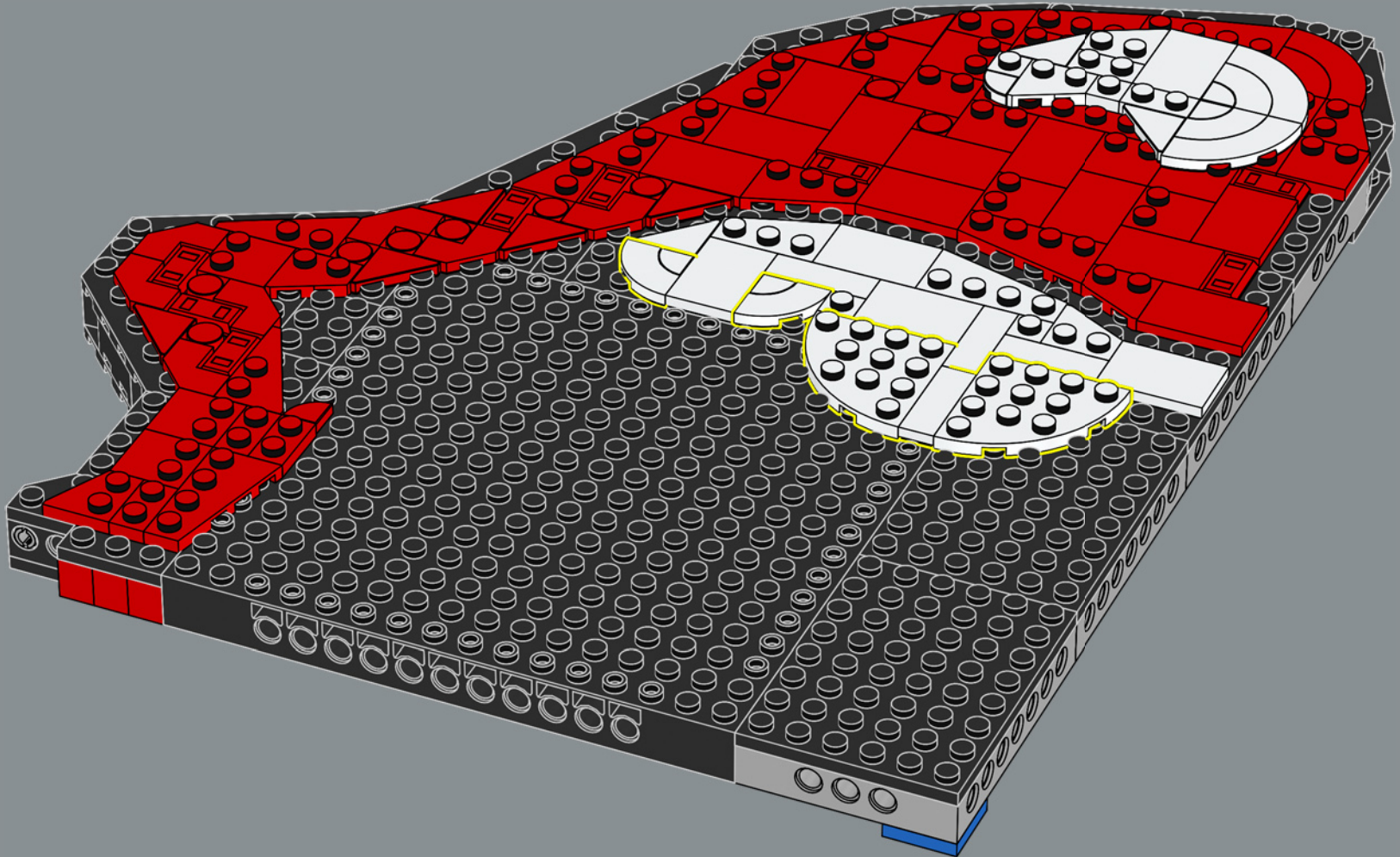

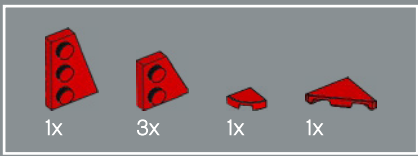

41

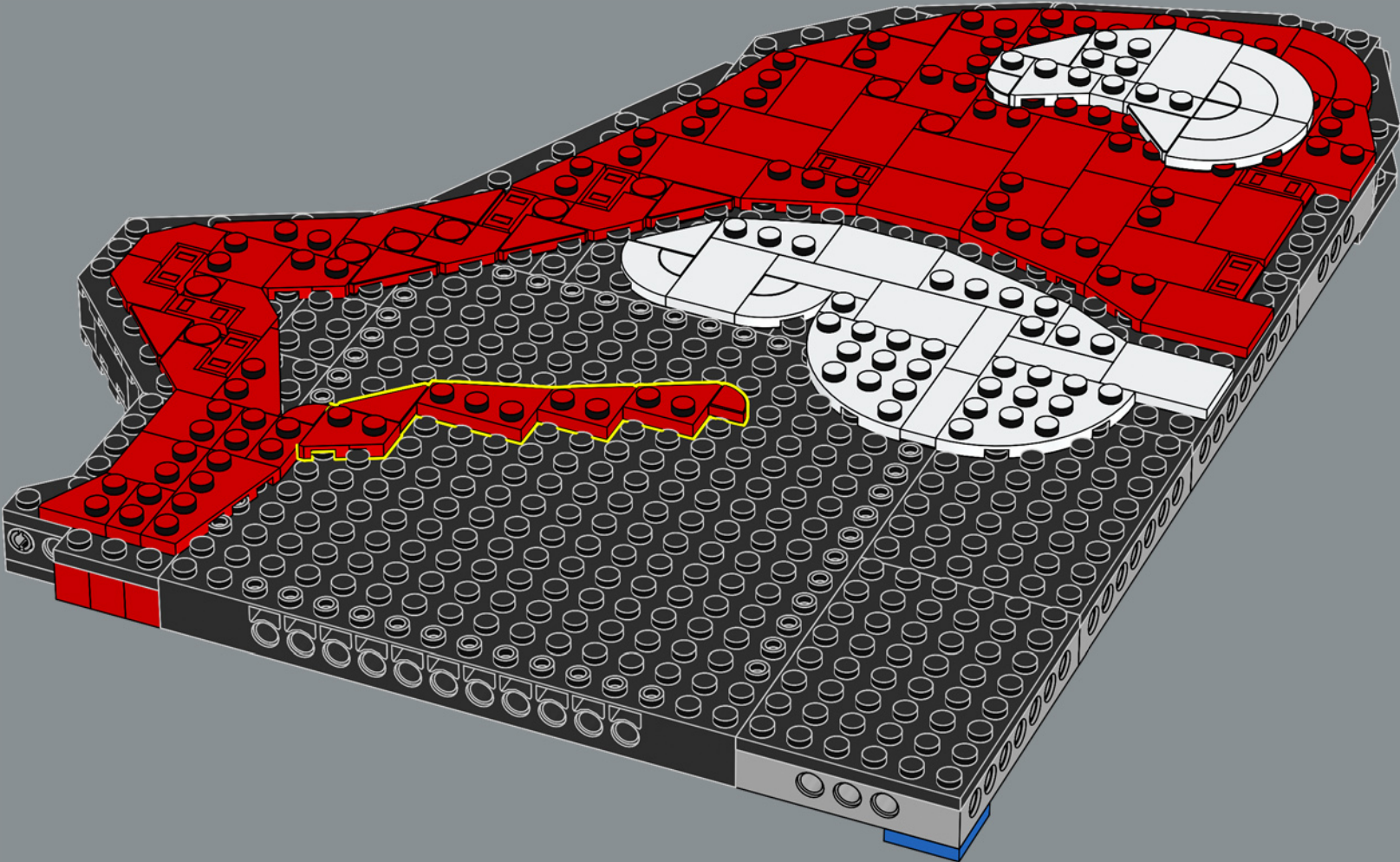

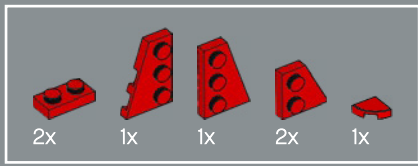

42

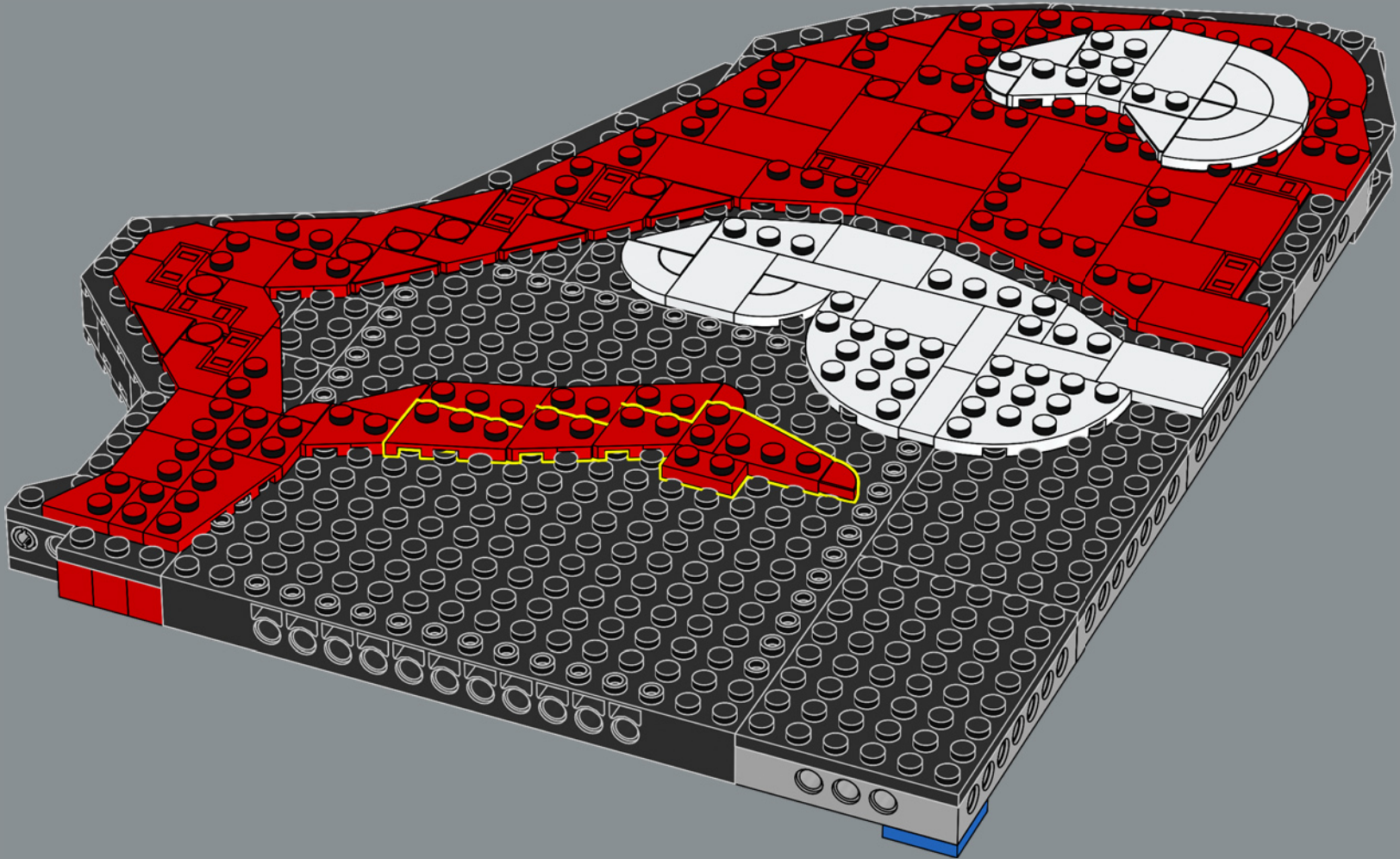



4x

43

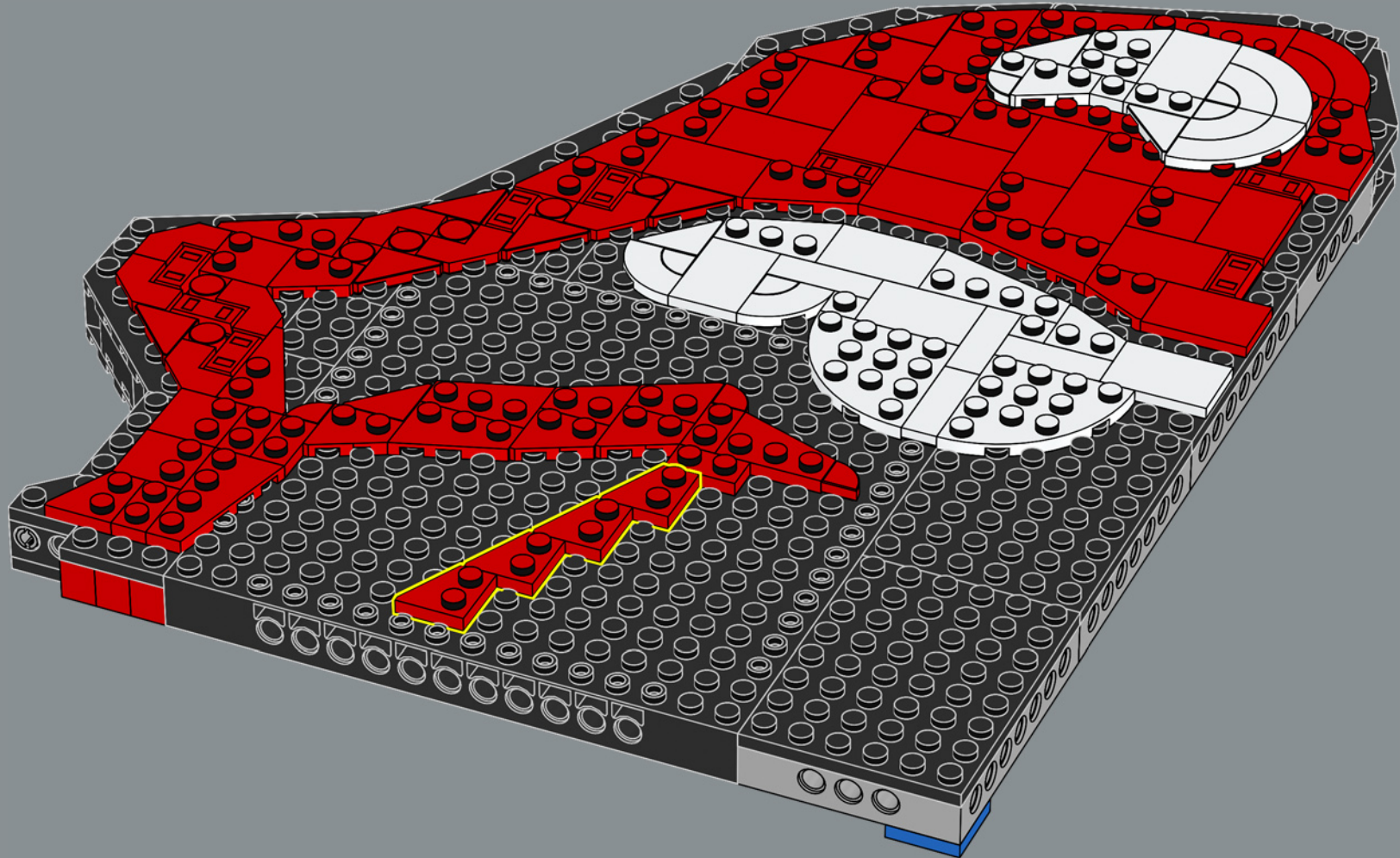

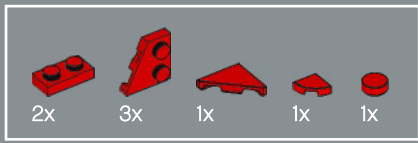

44

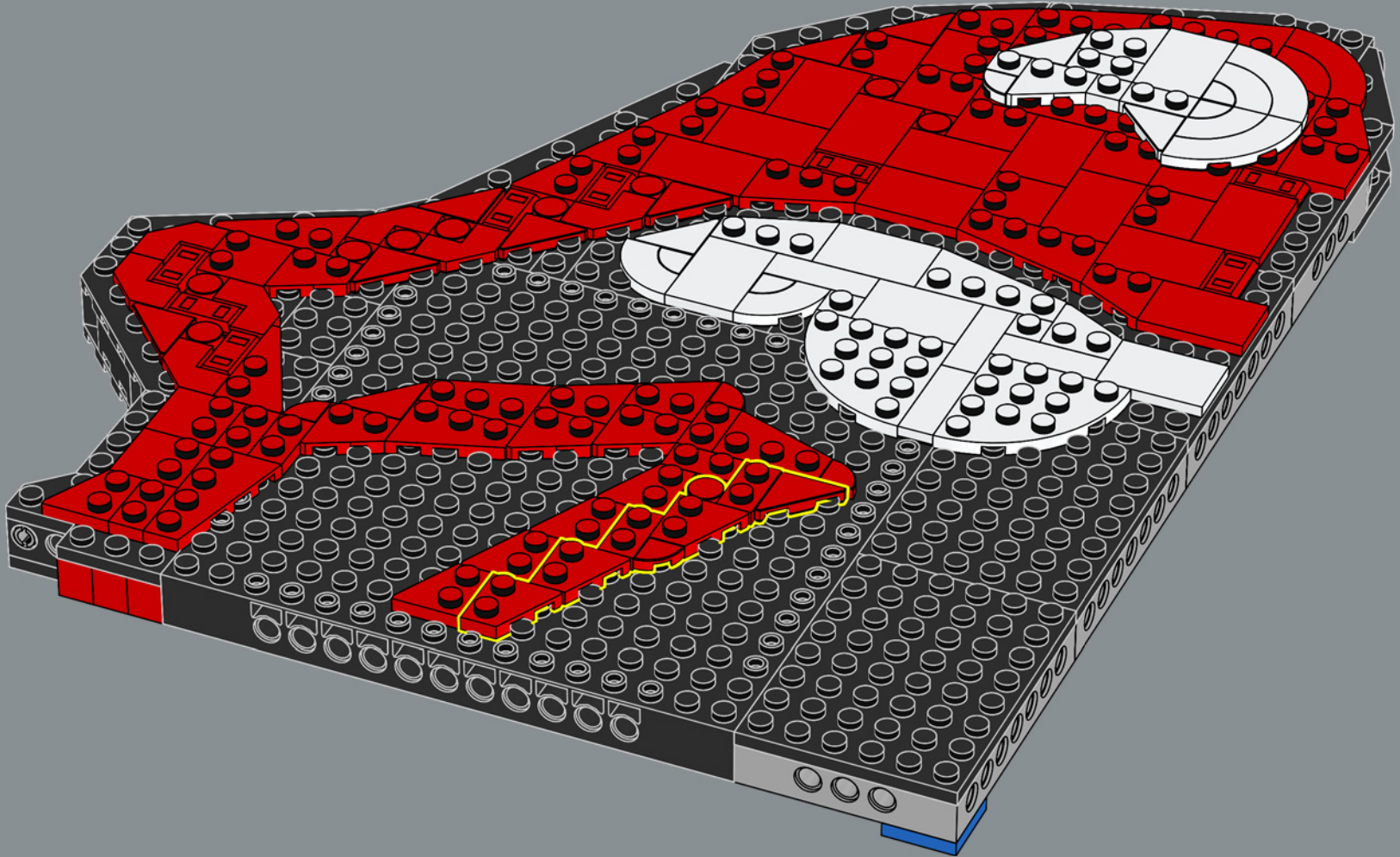

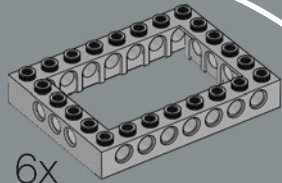
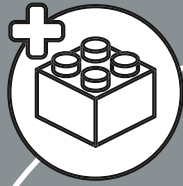

6x

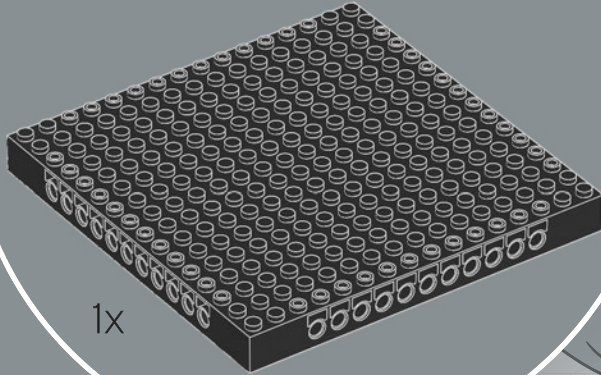

1x



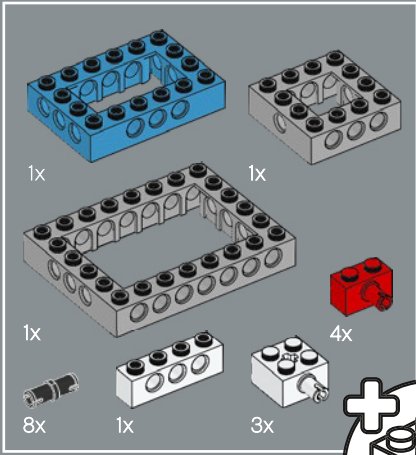
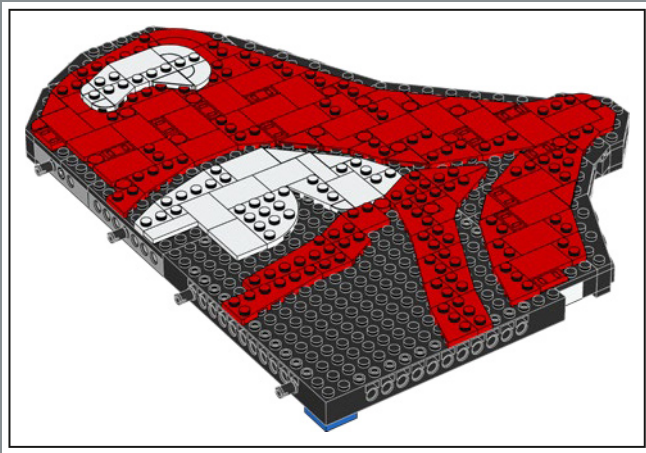

45

1

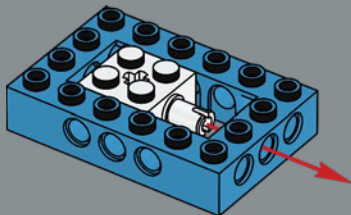

2

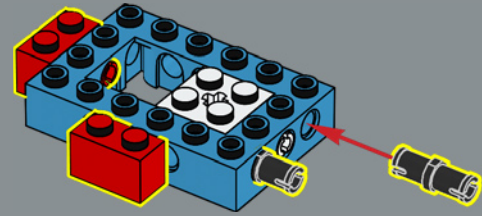

3

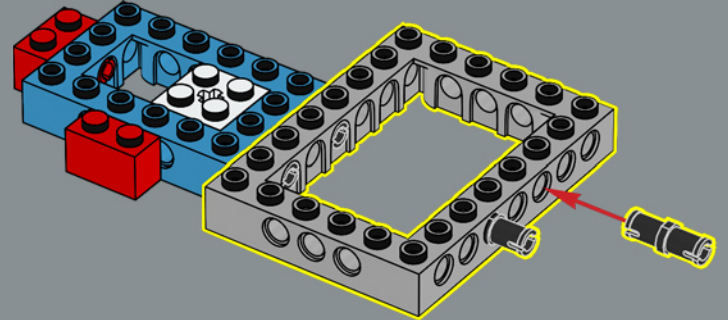

4

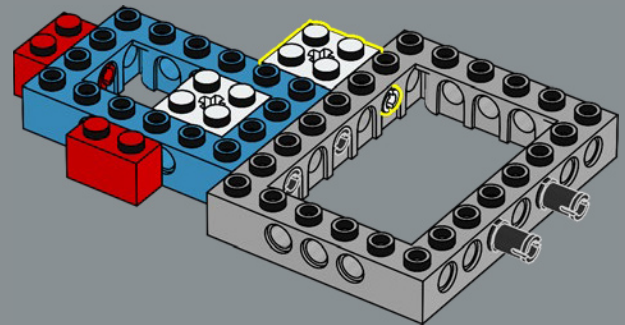

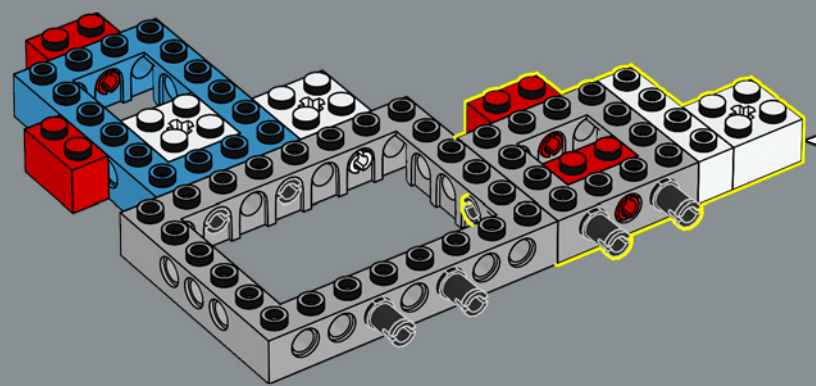
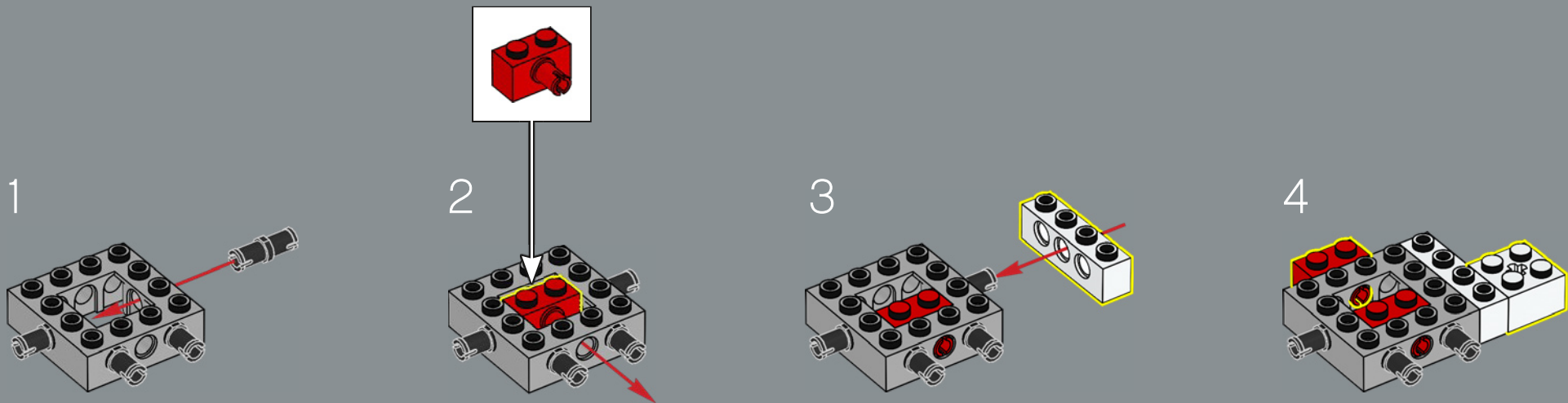

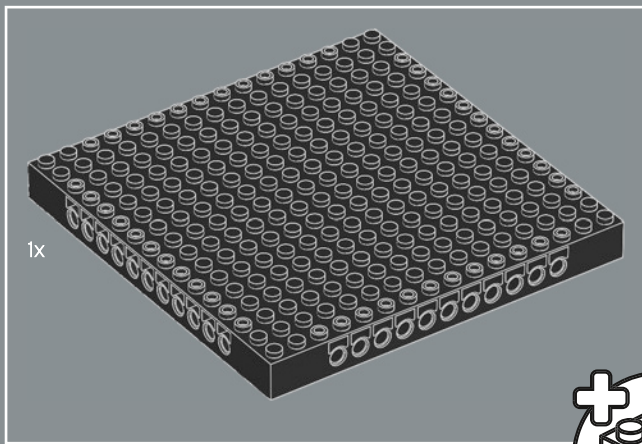

1x

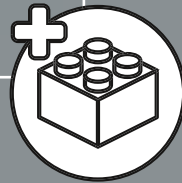

46

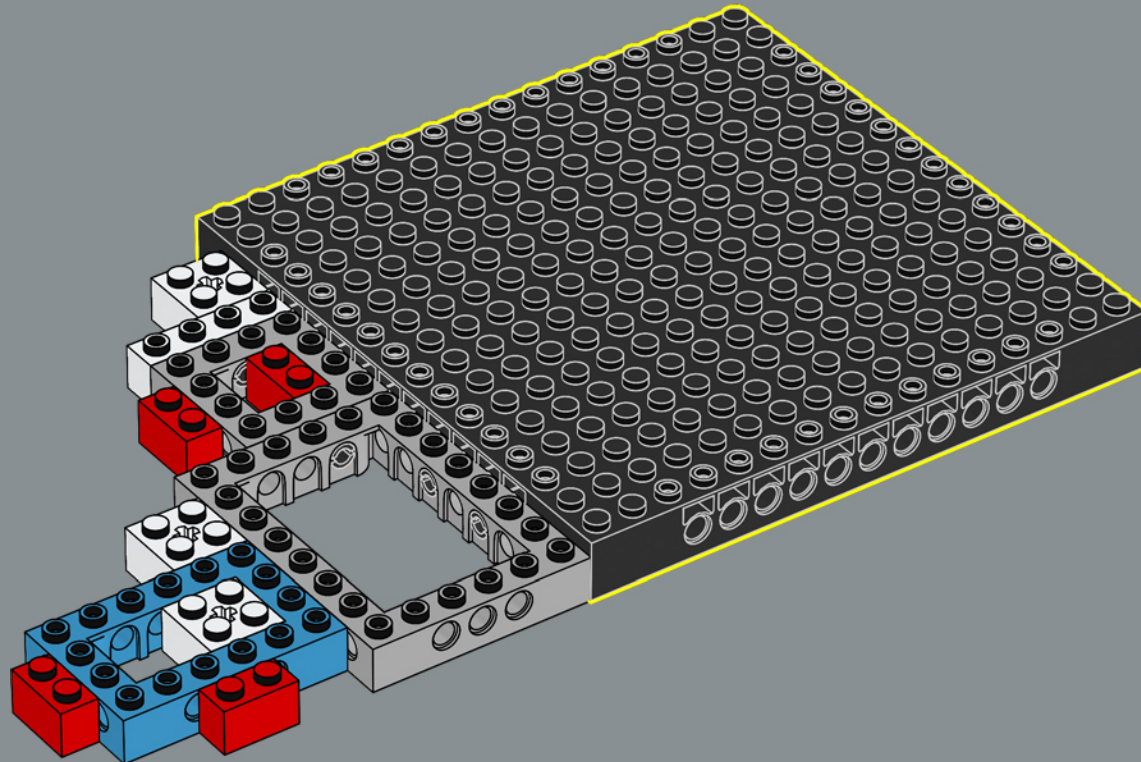

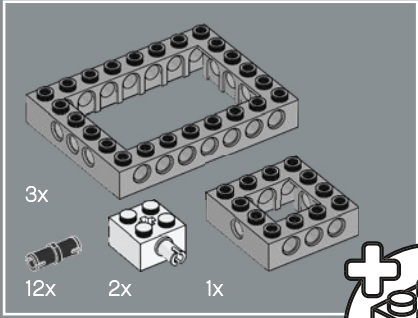
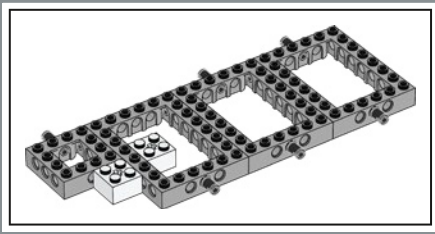

47

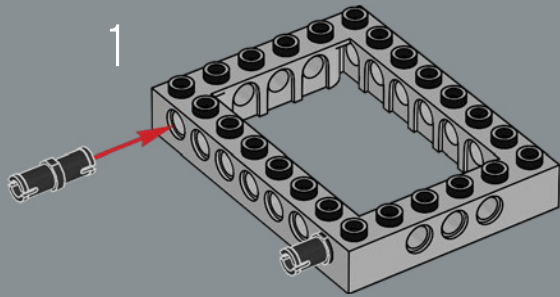

2

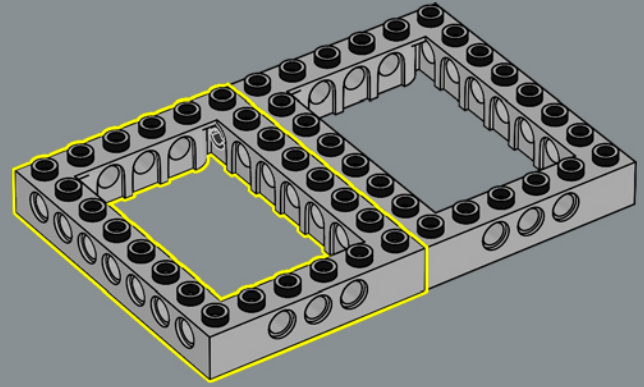

3

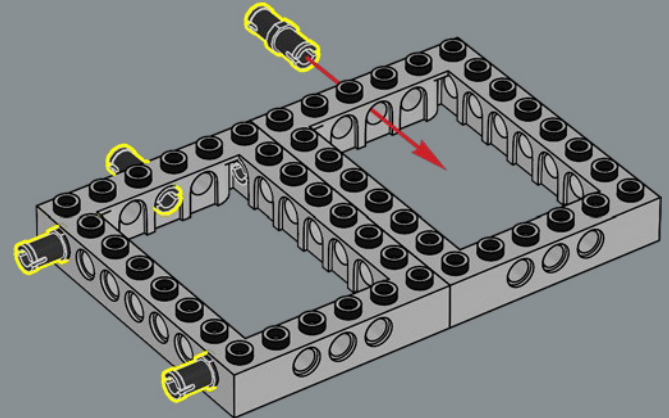

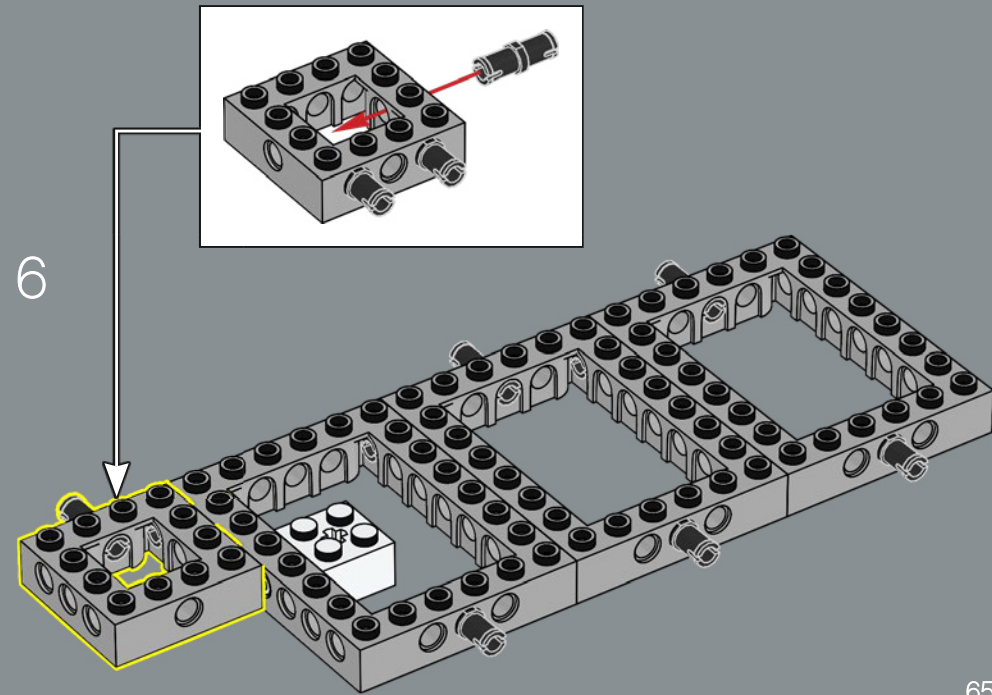
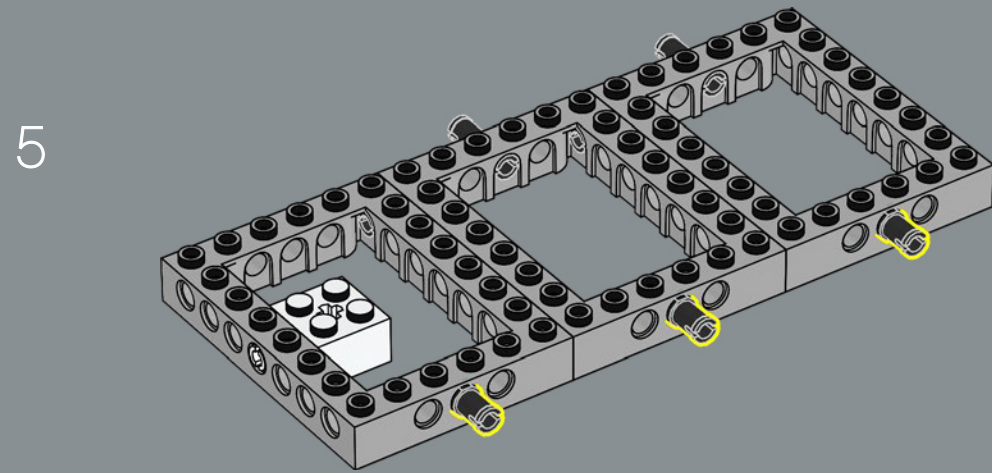
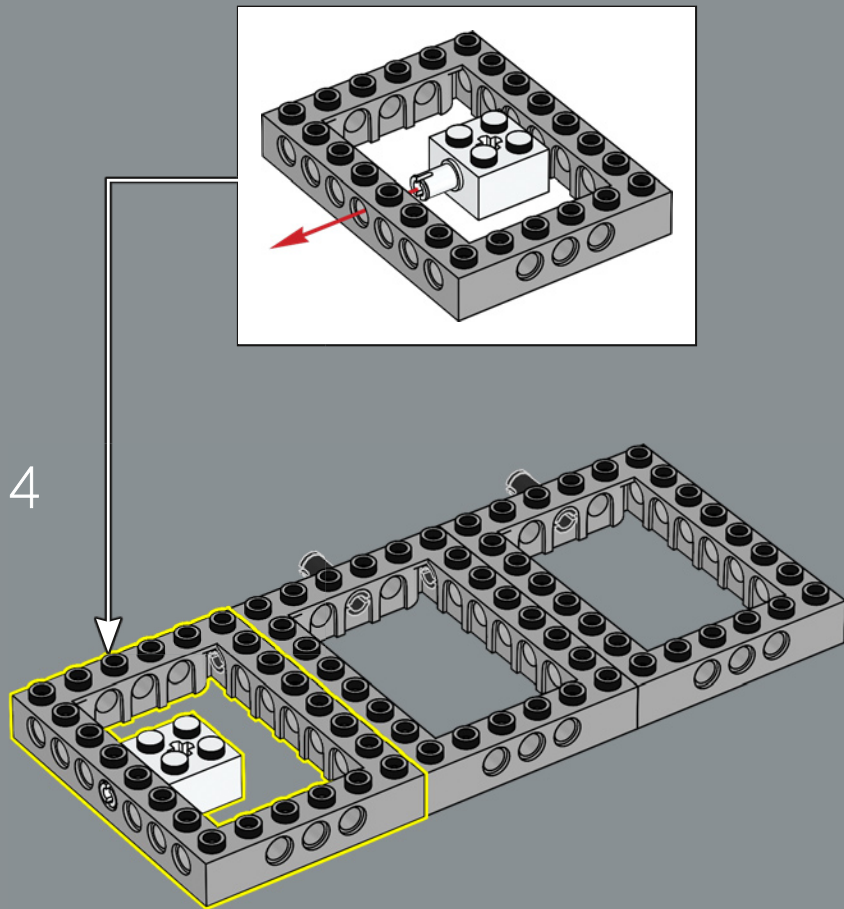

7

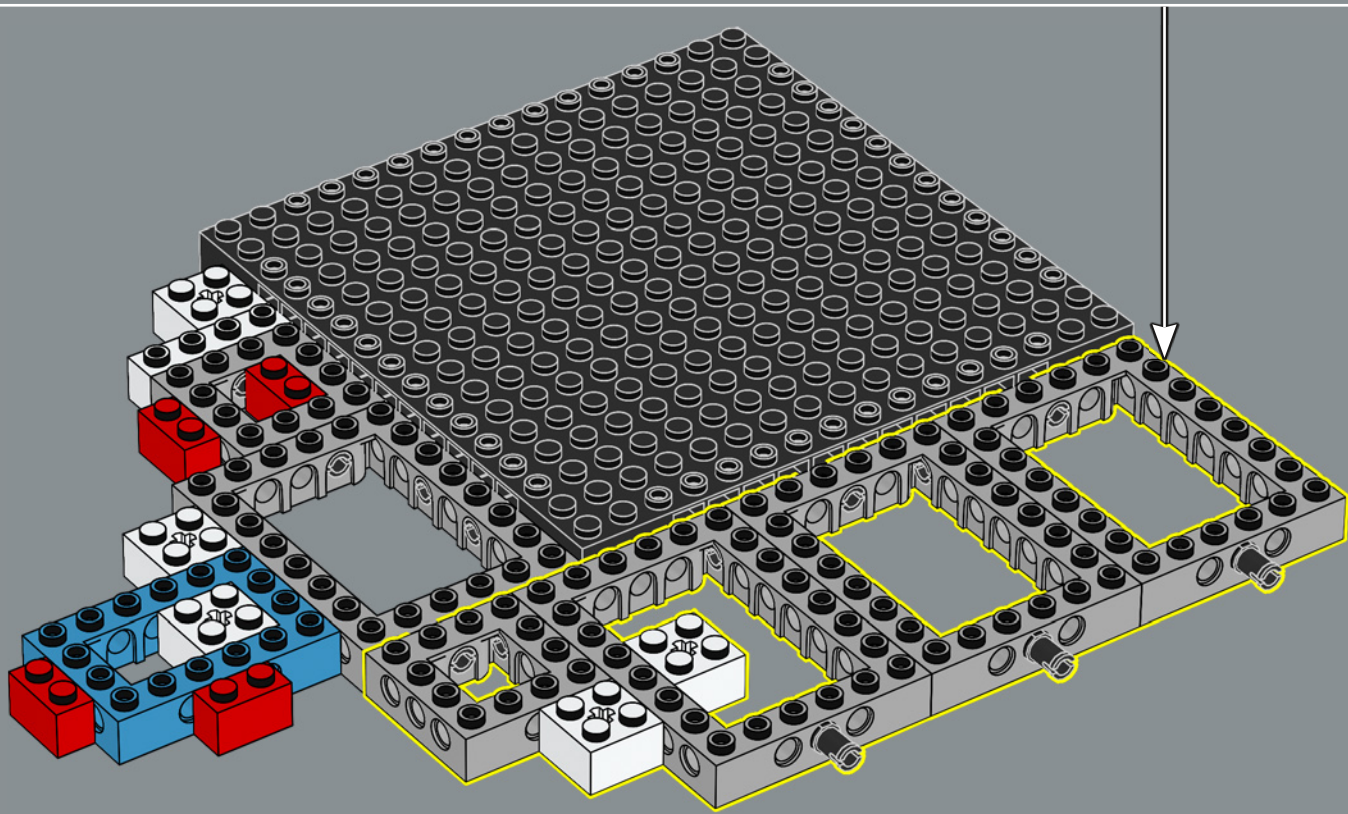
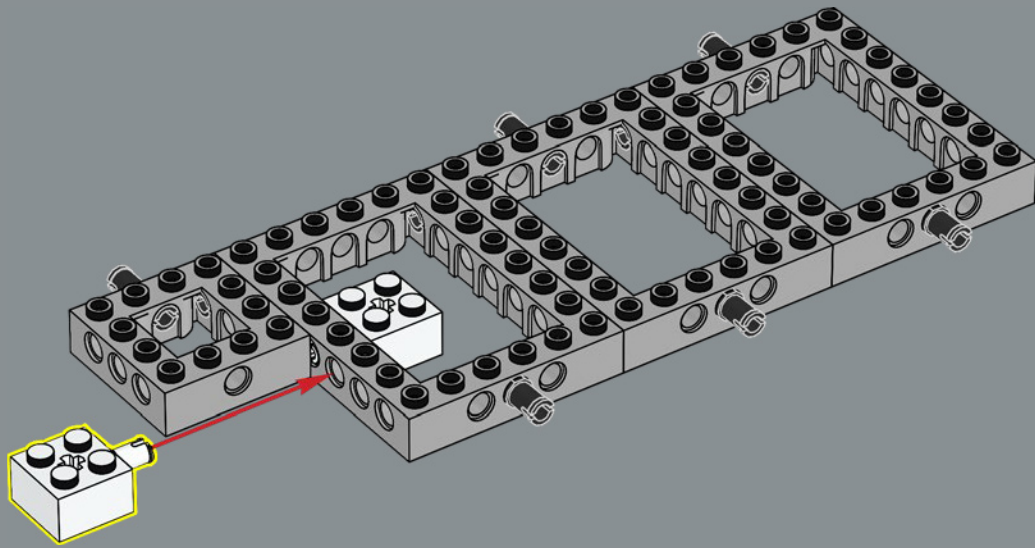

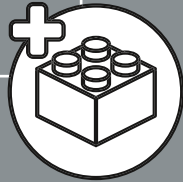
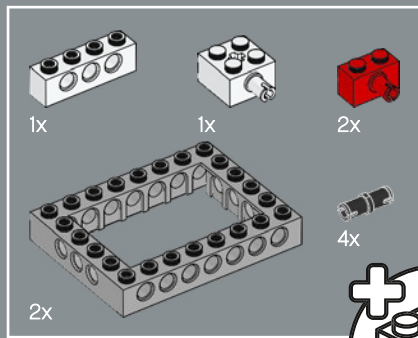

48

1

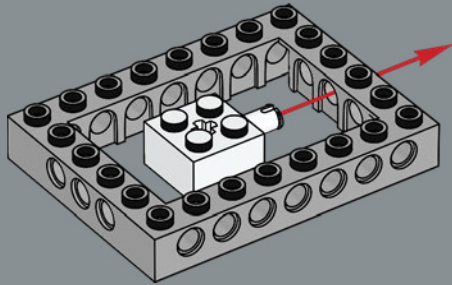

2

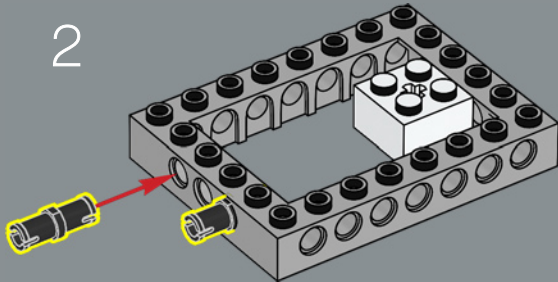

3

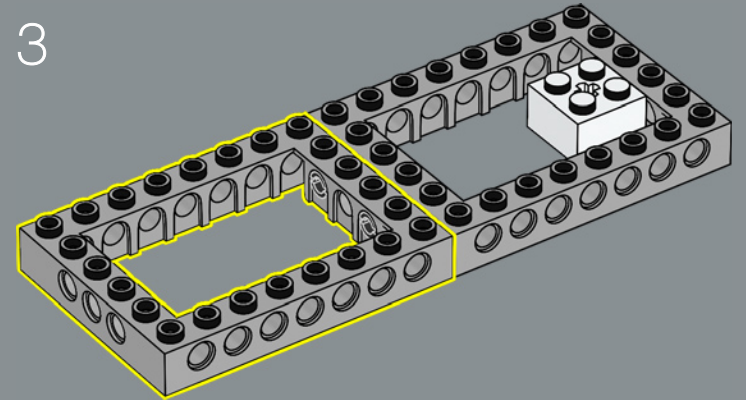

4

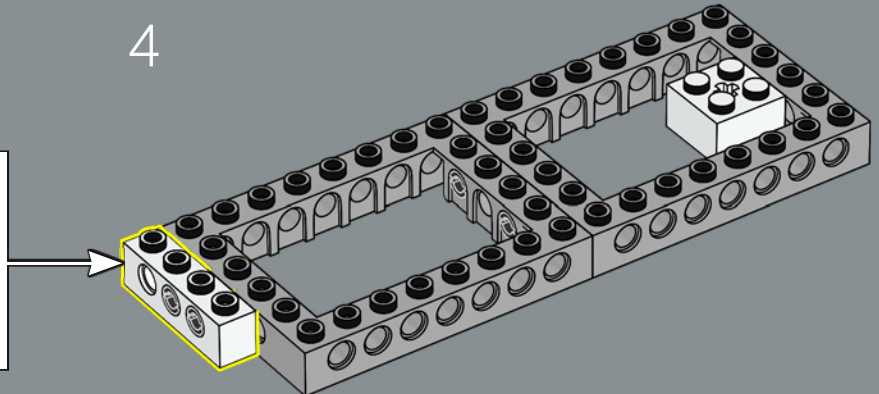
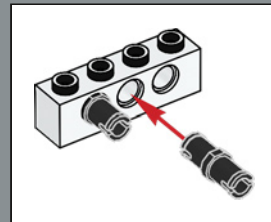

5

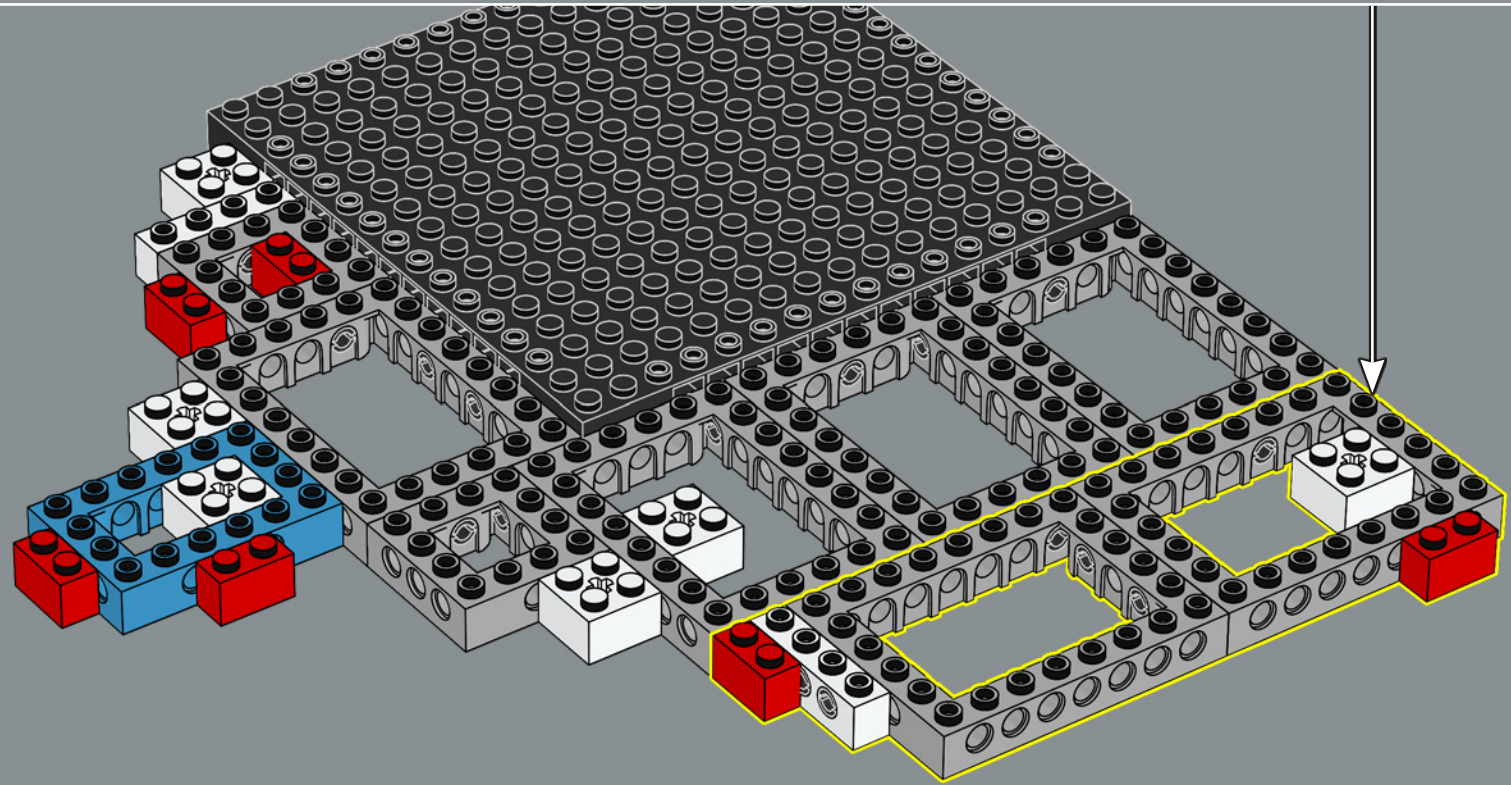
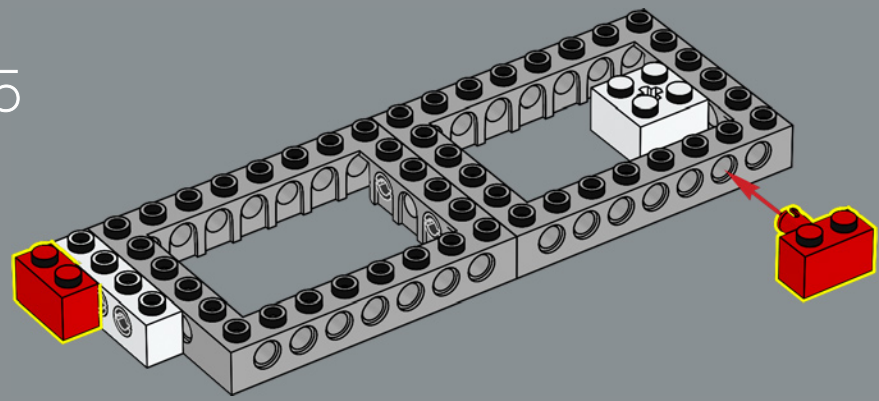

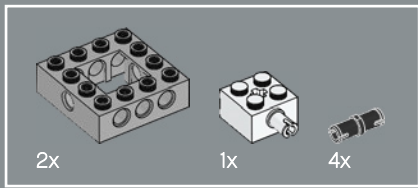

49 1

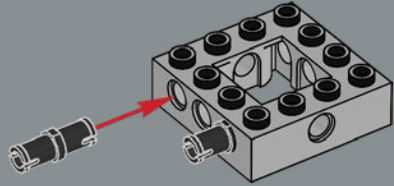

2

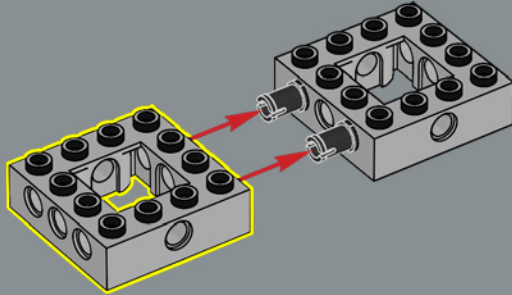

3

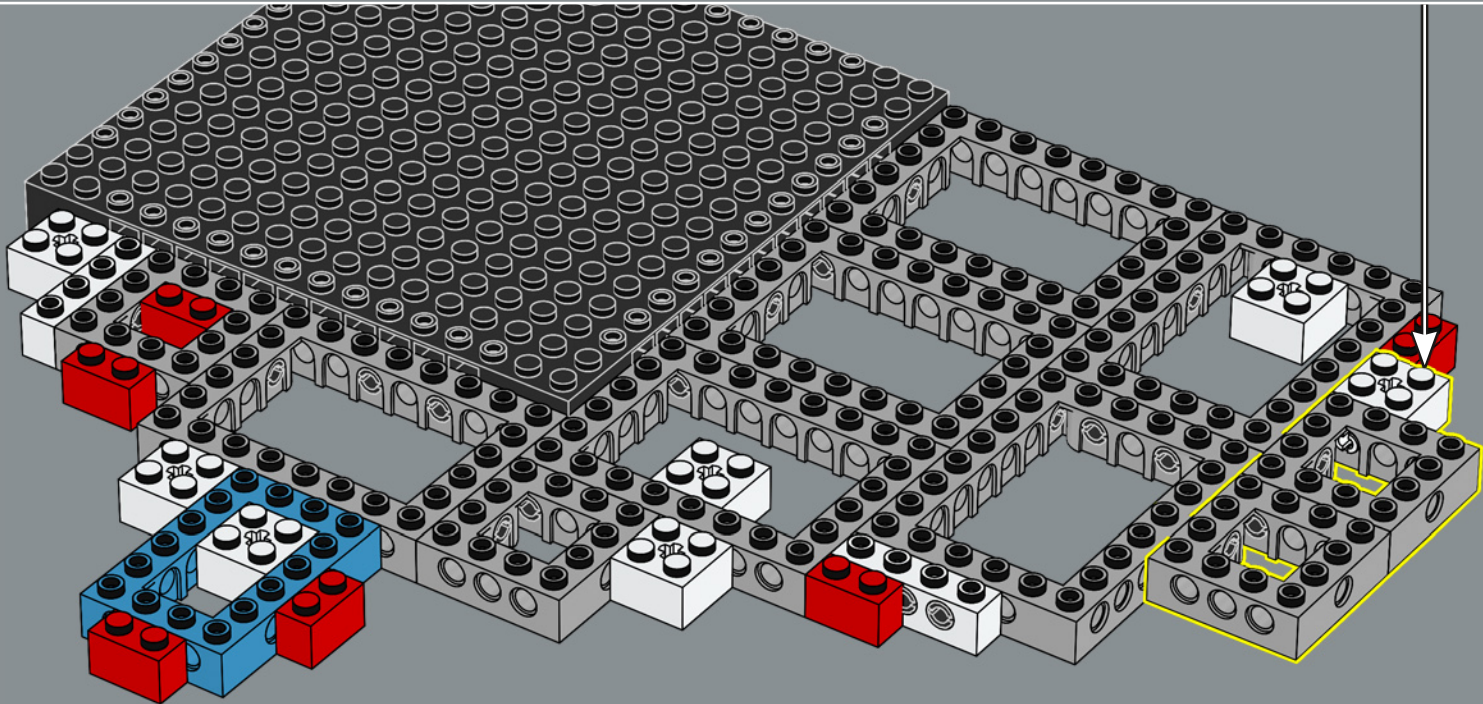
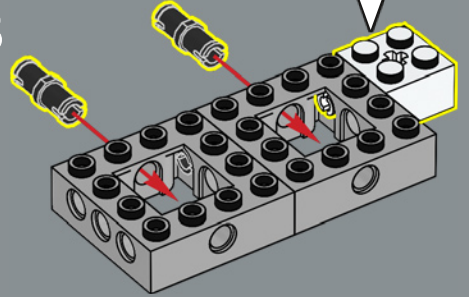

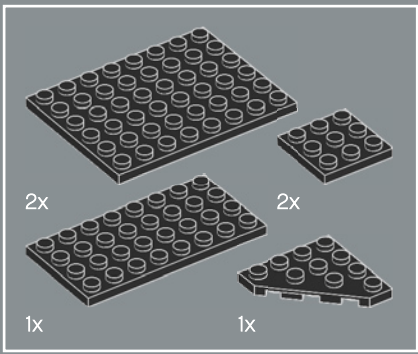

50

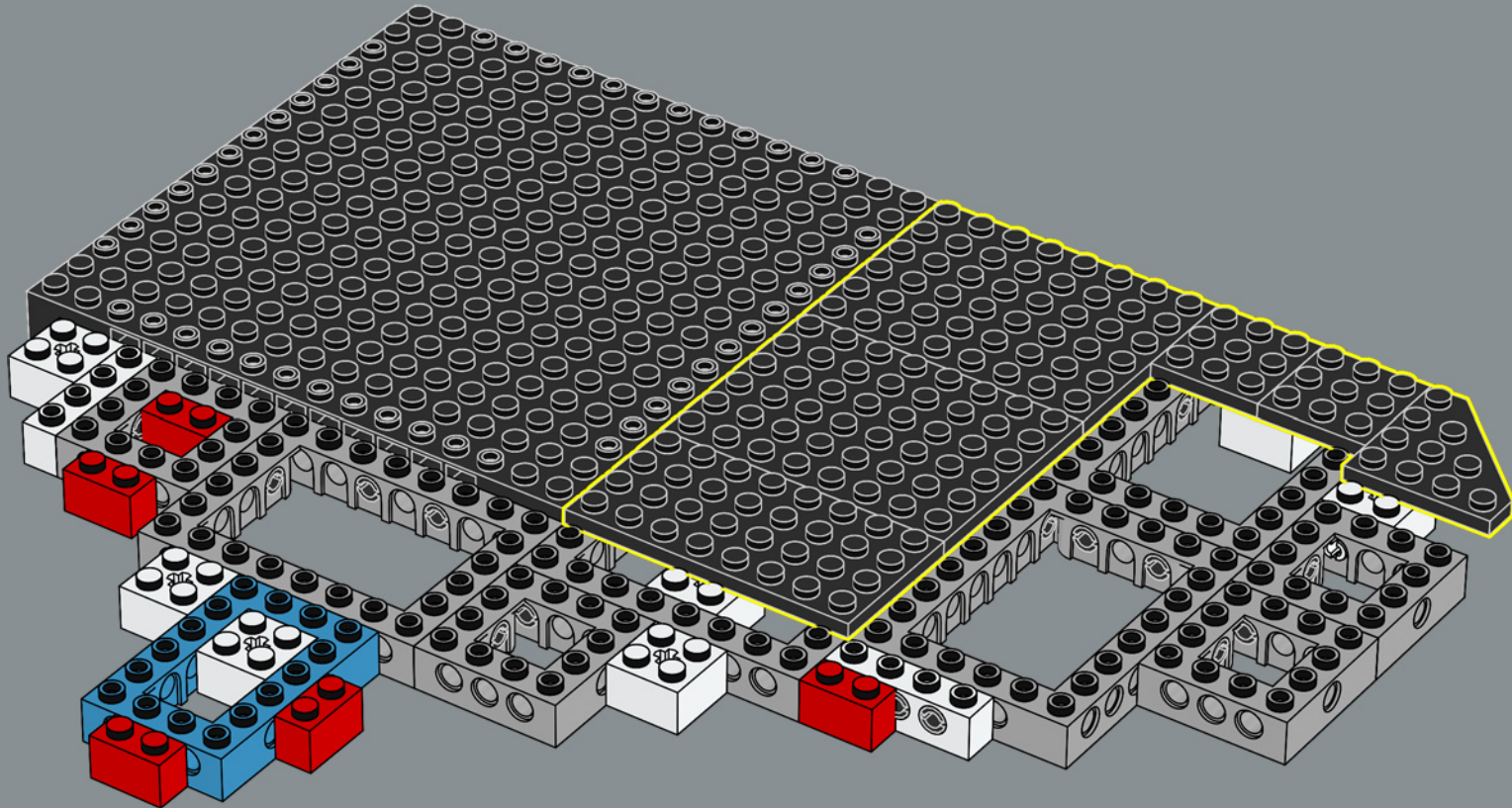

70

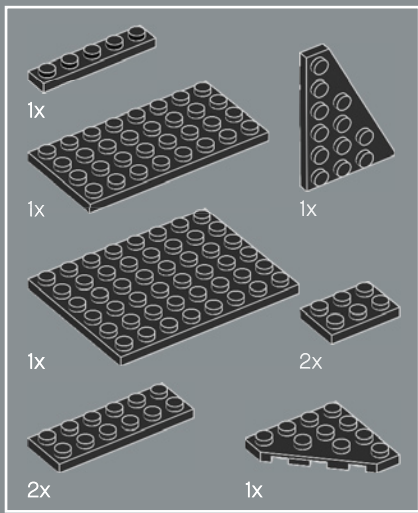

51

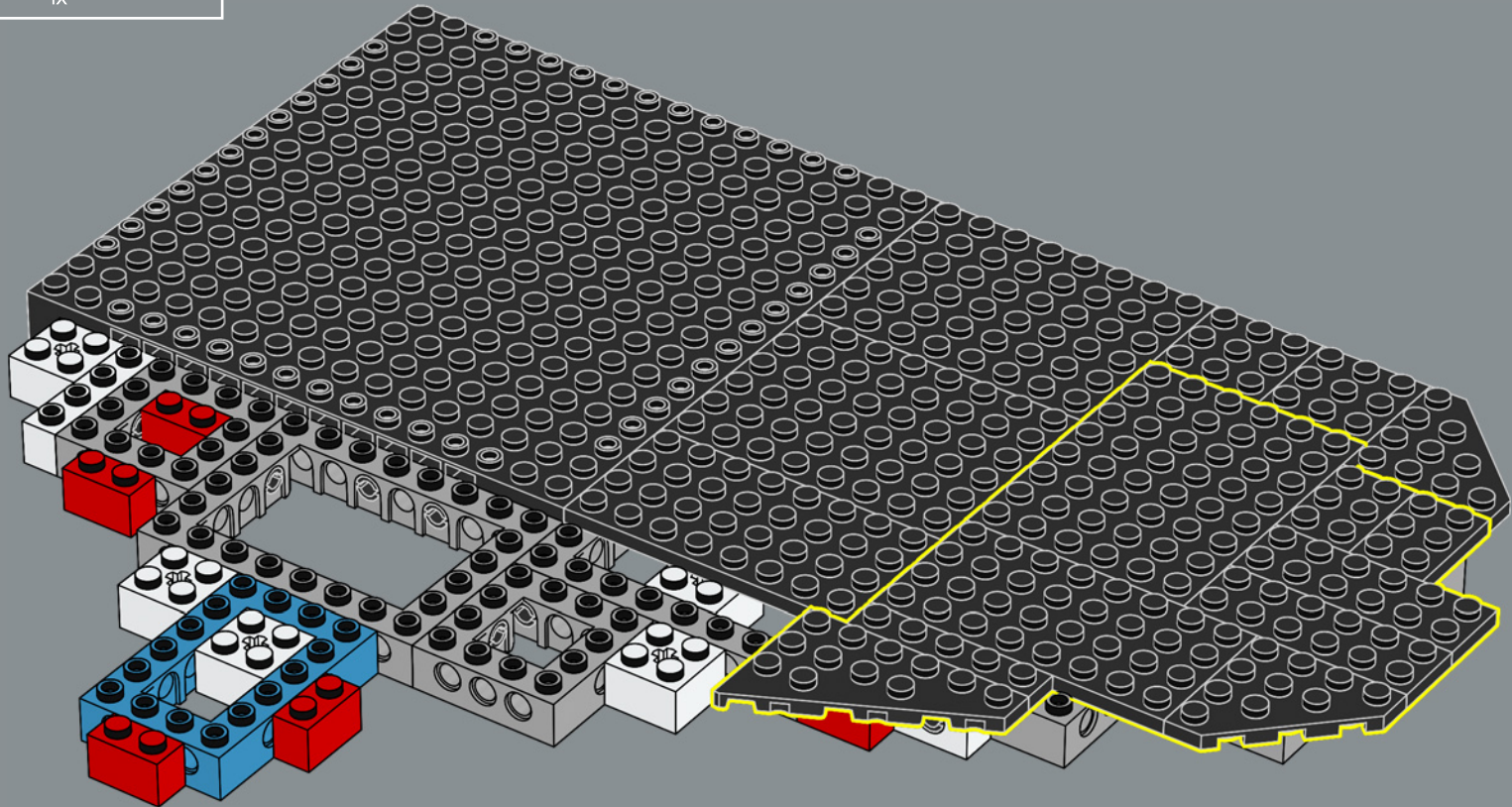

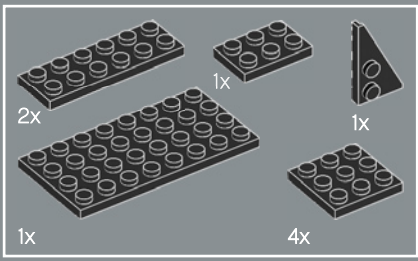

52

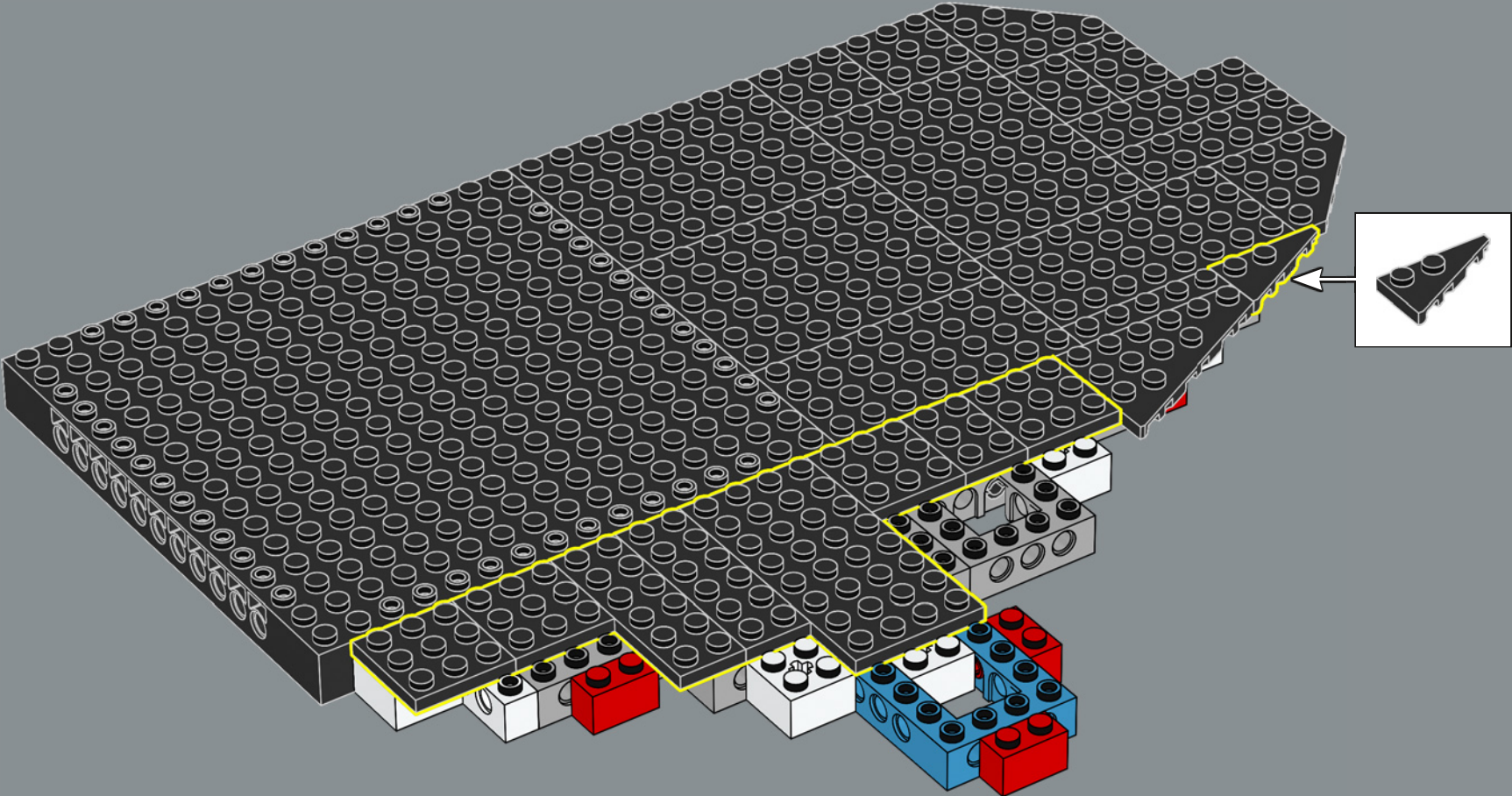

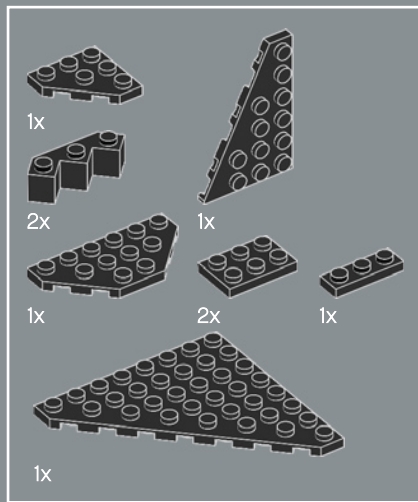

53

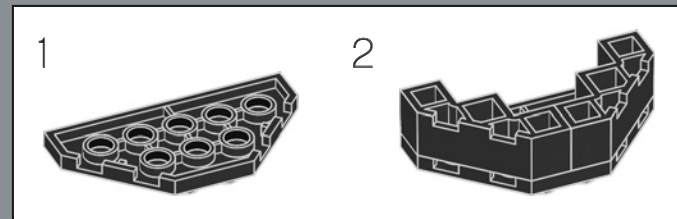
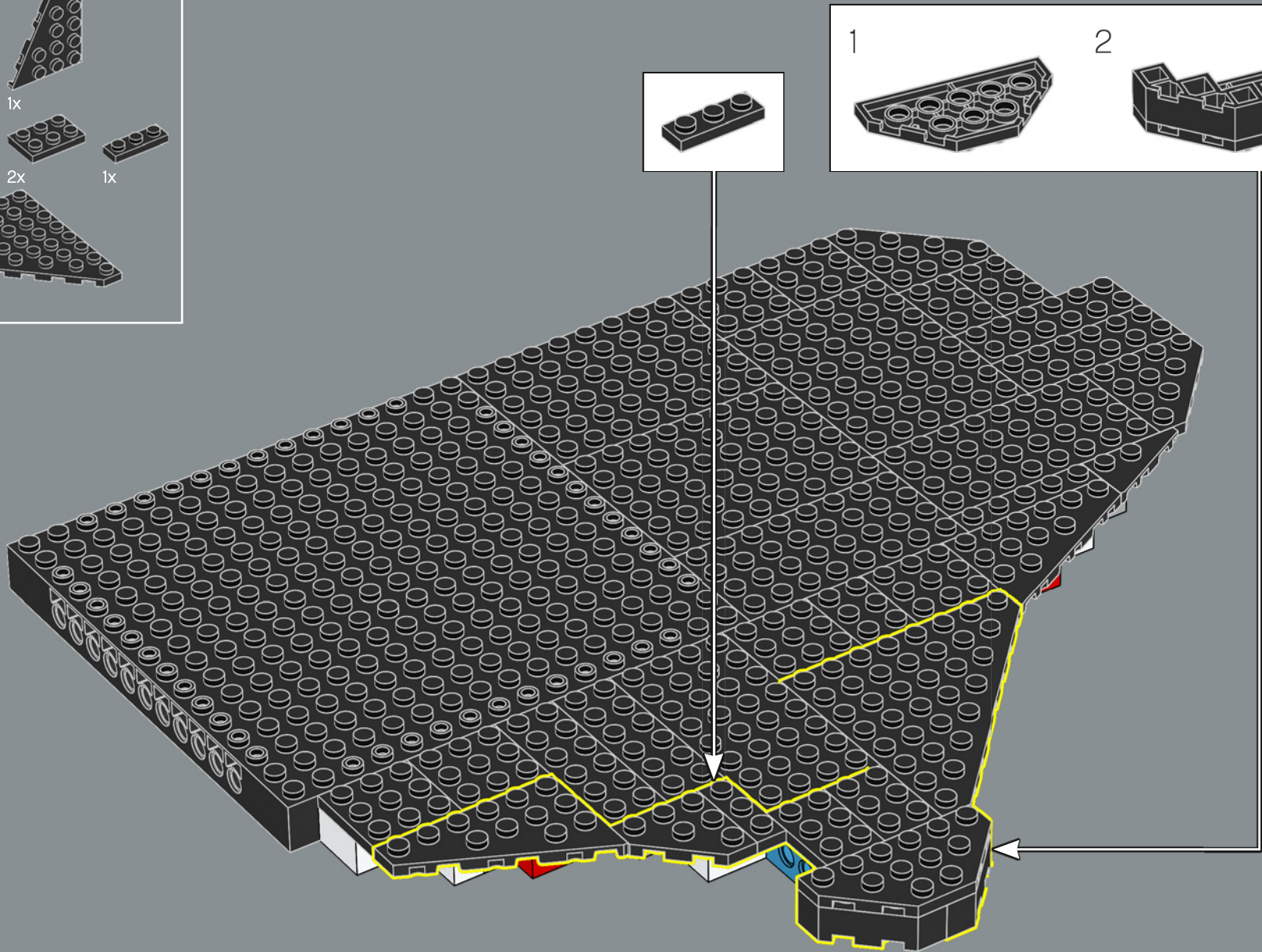

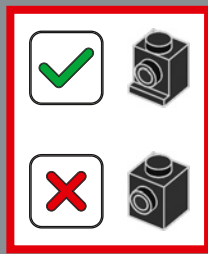
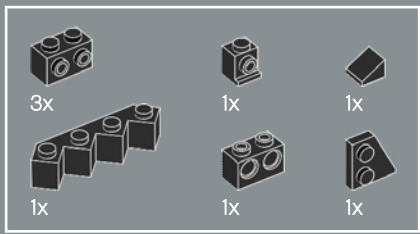

54

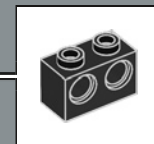
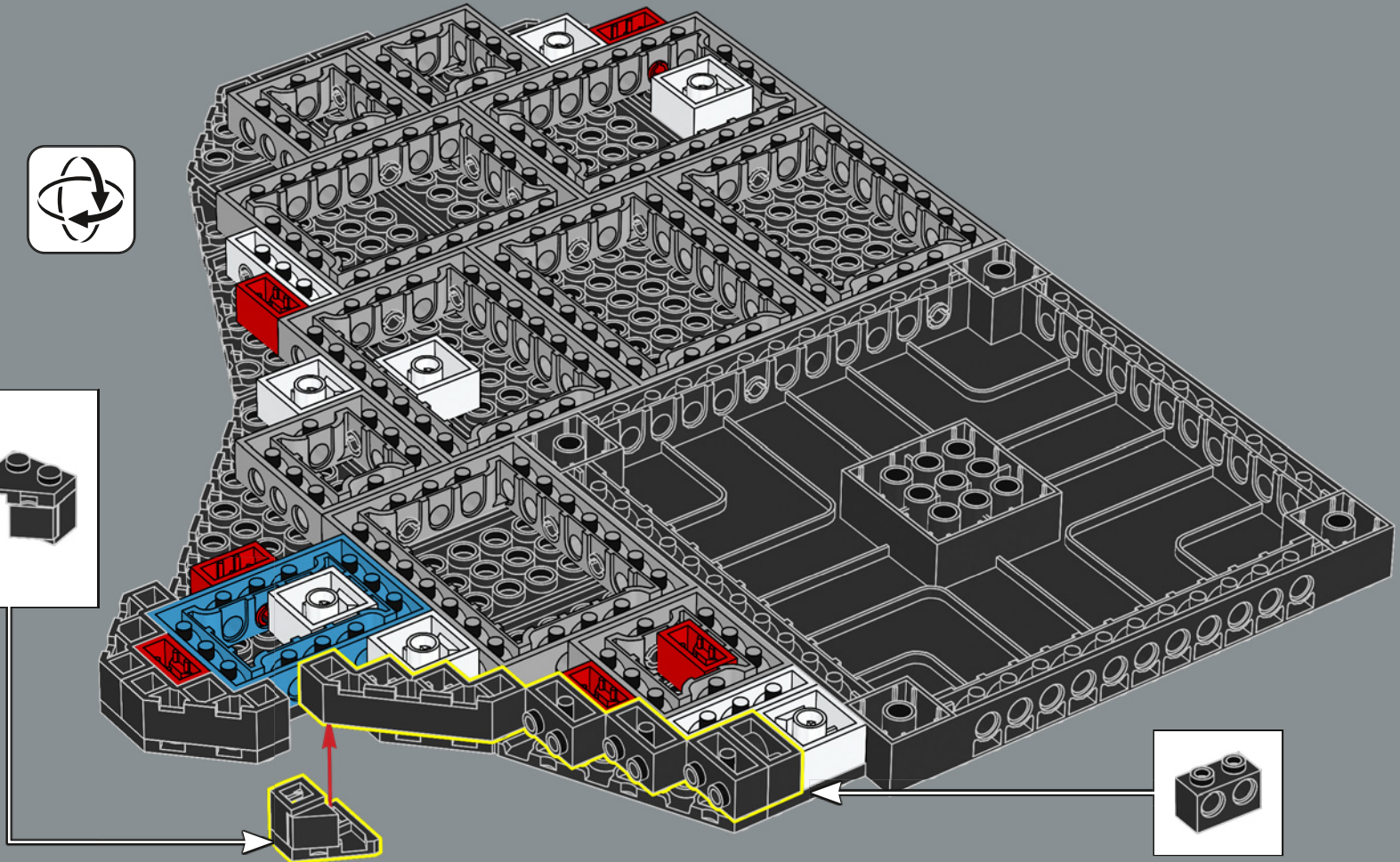
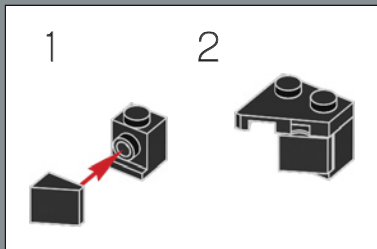

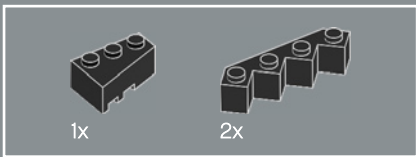

55

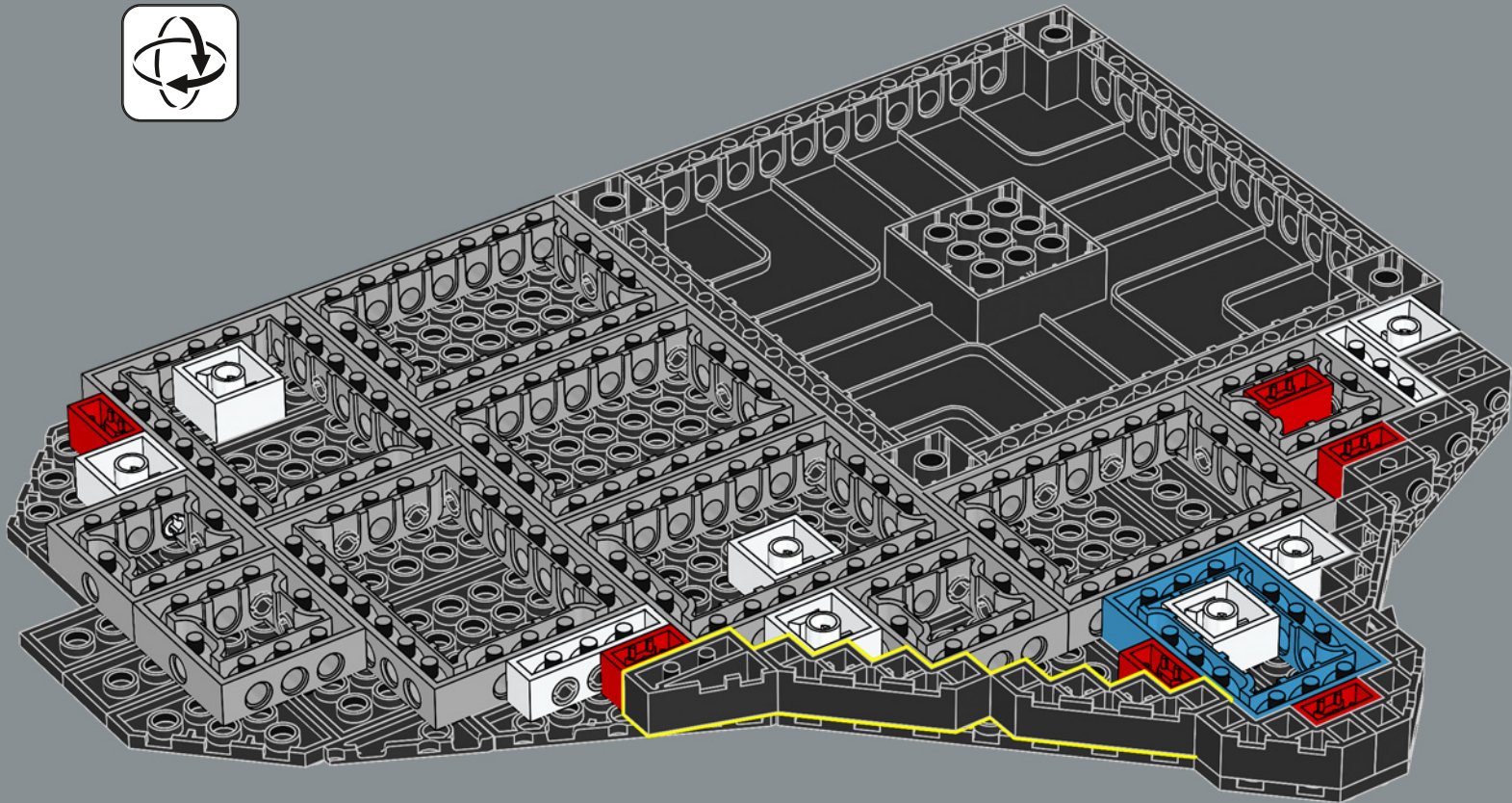

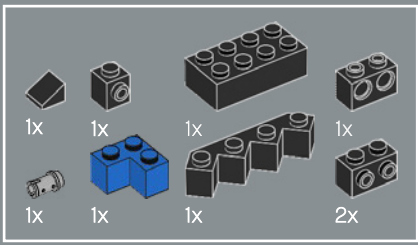

56

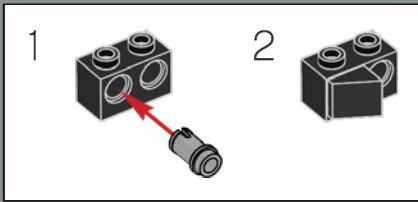
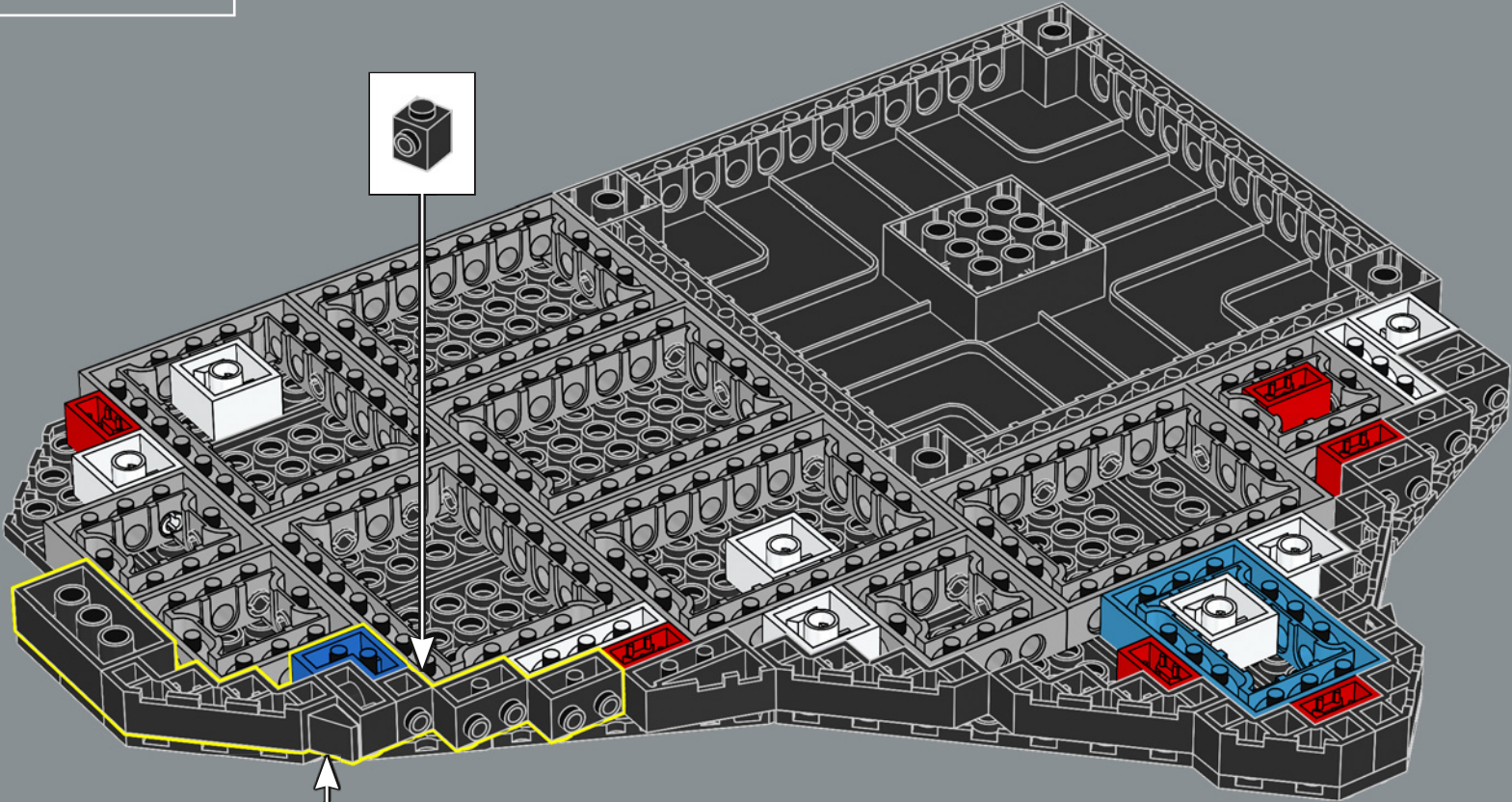



57

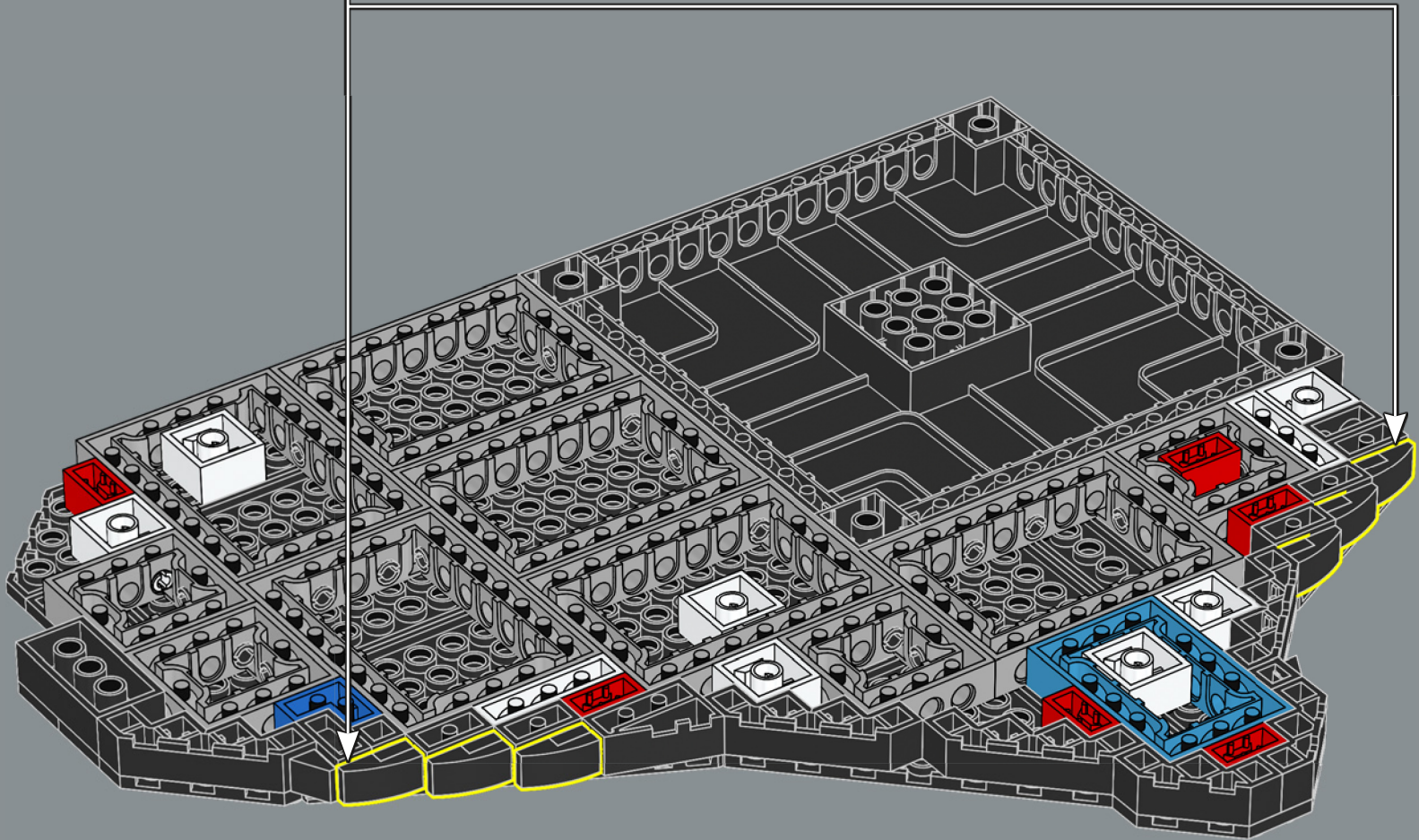
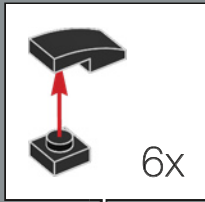

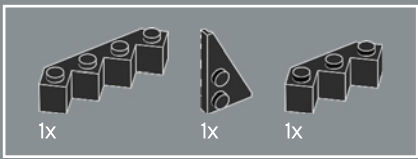

58

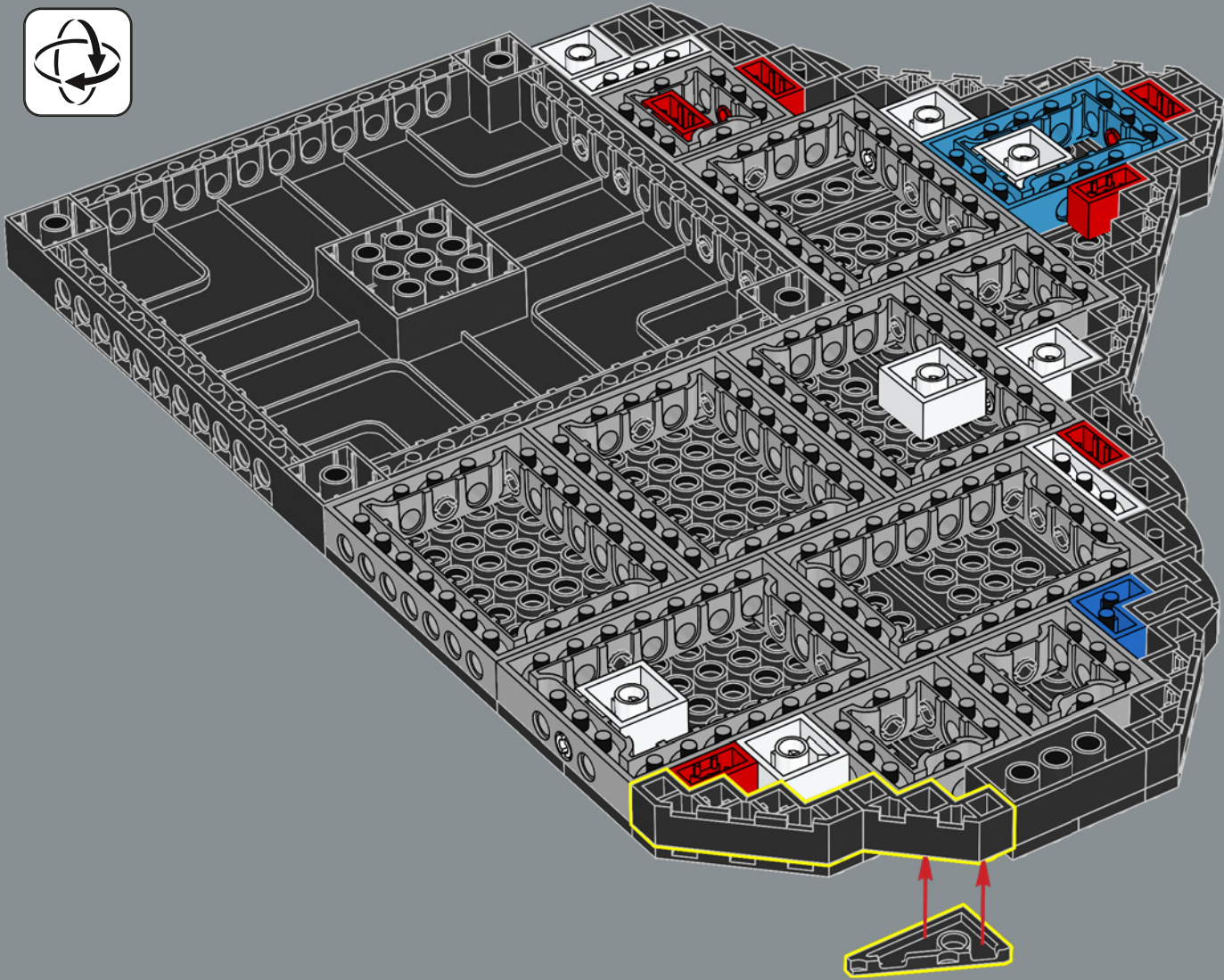

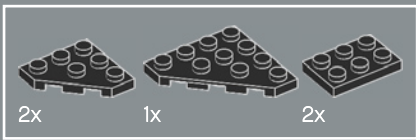

59

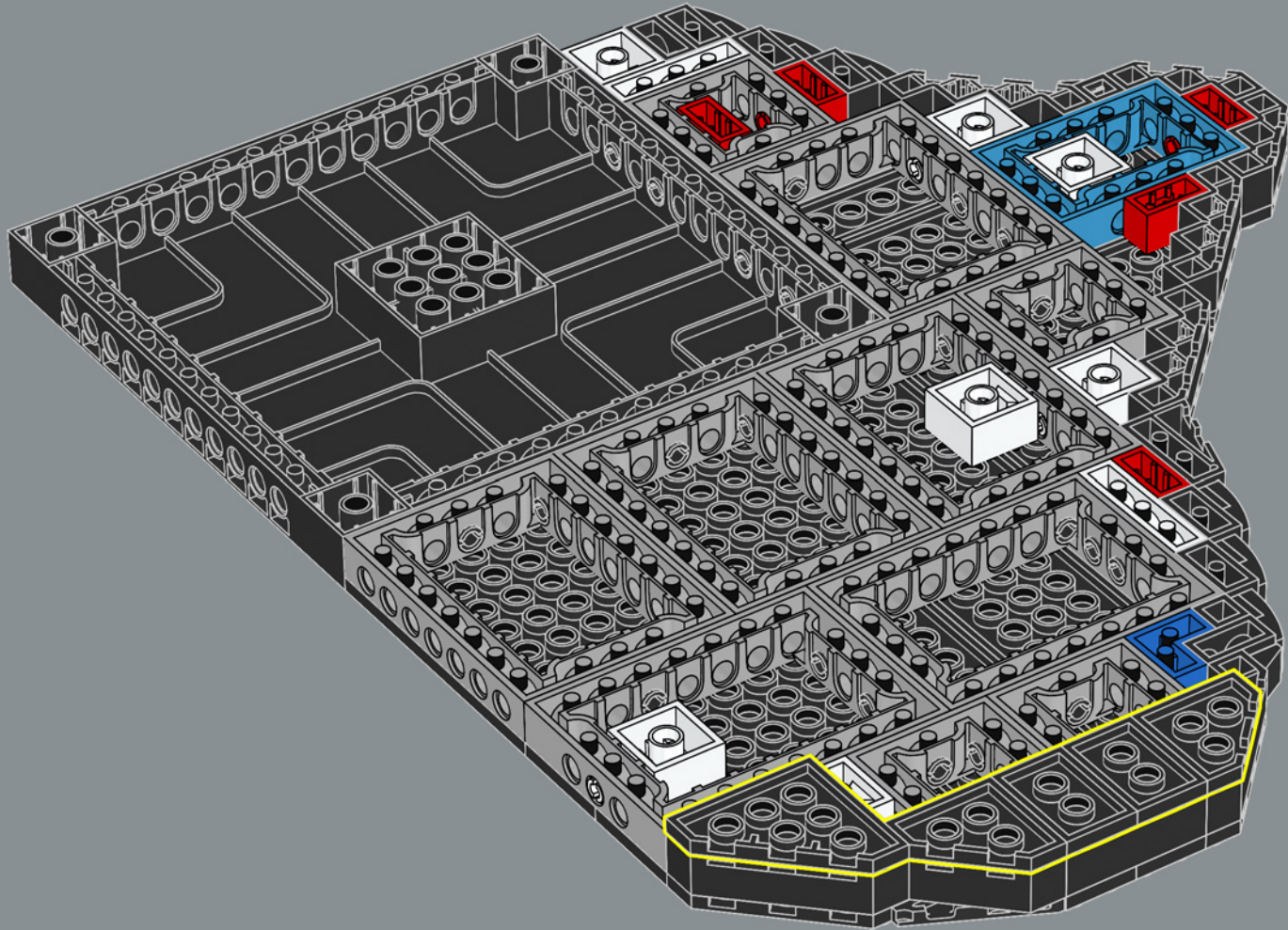

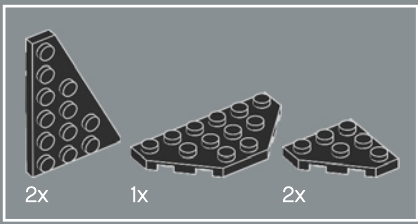

60

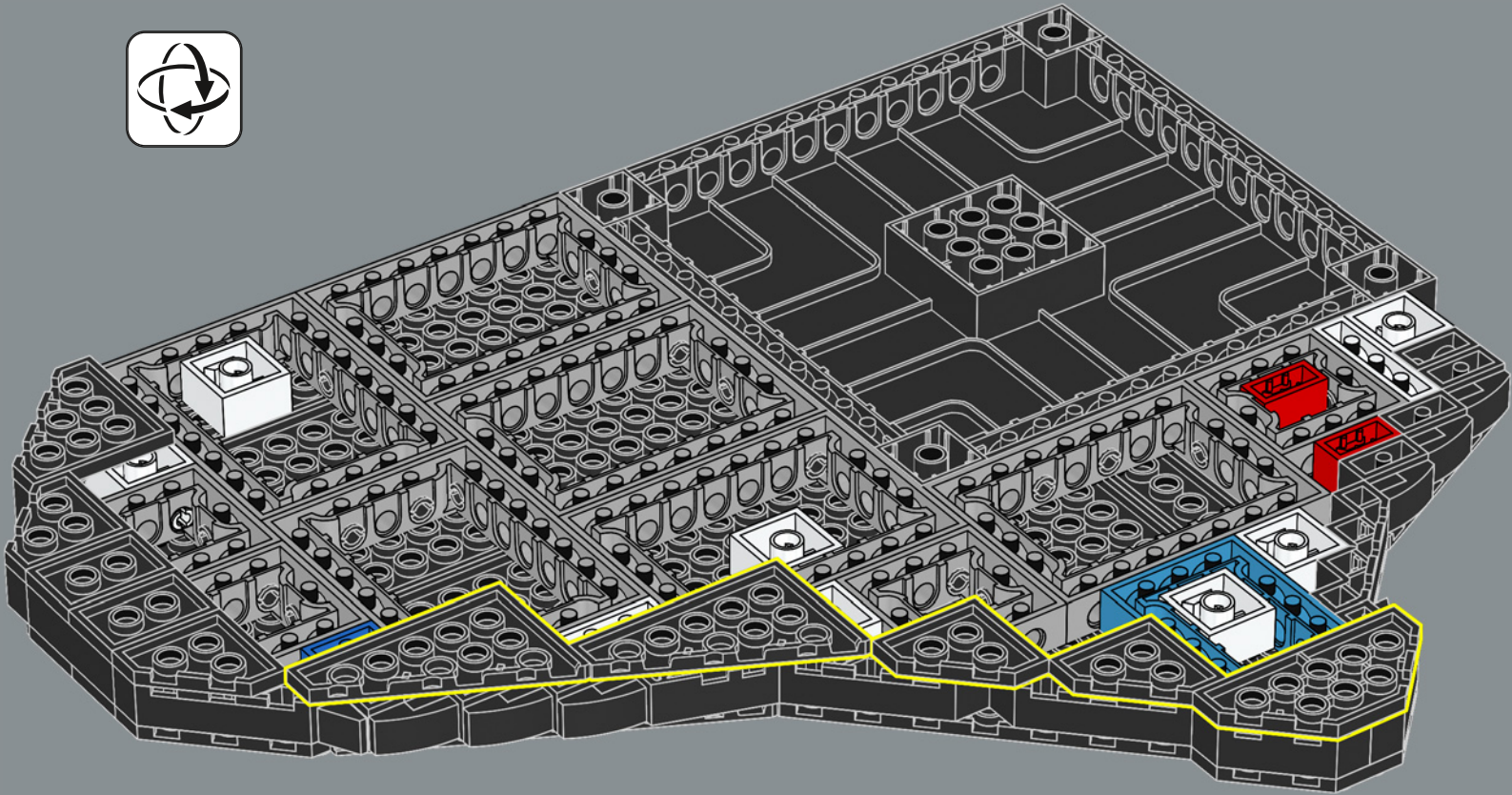

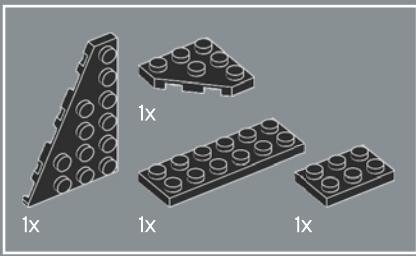

61

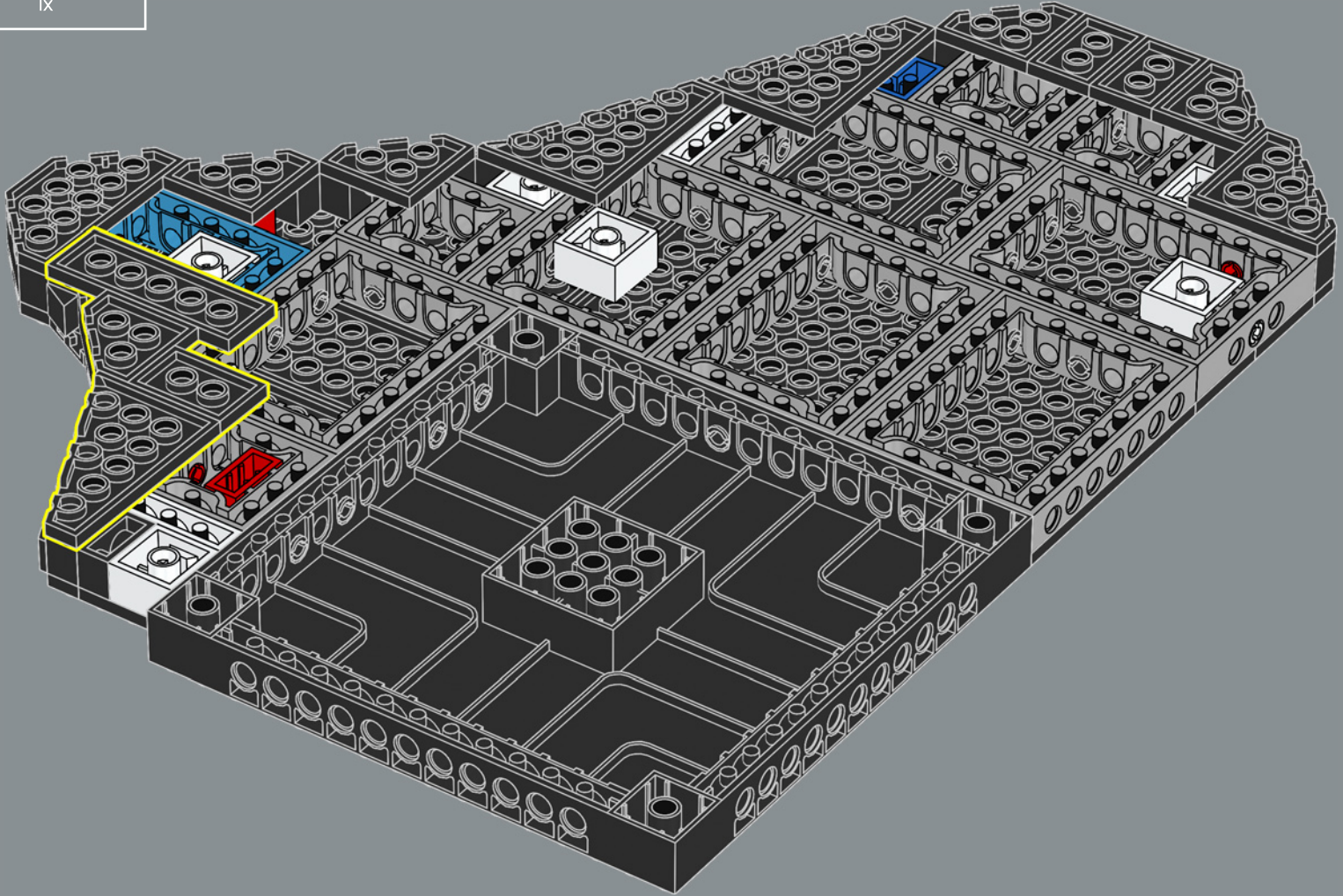

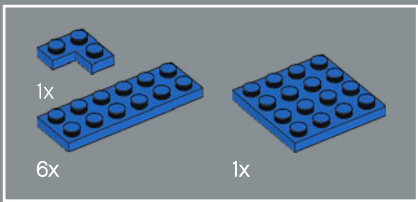

62

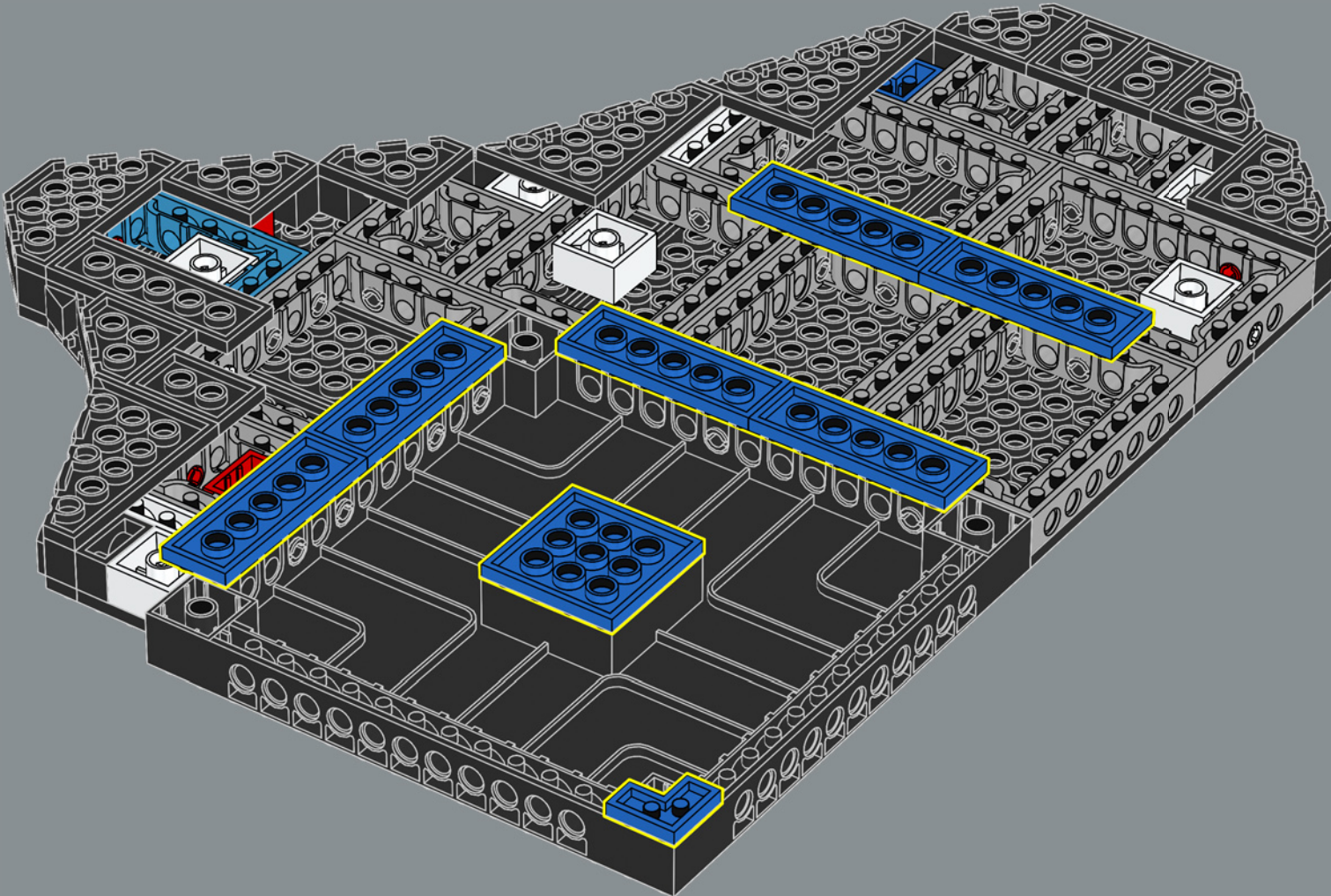





4x

63

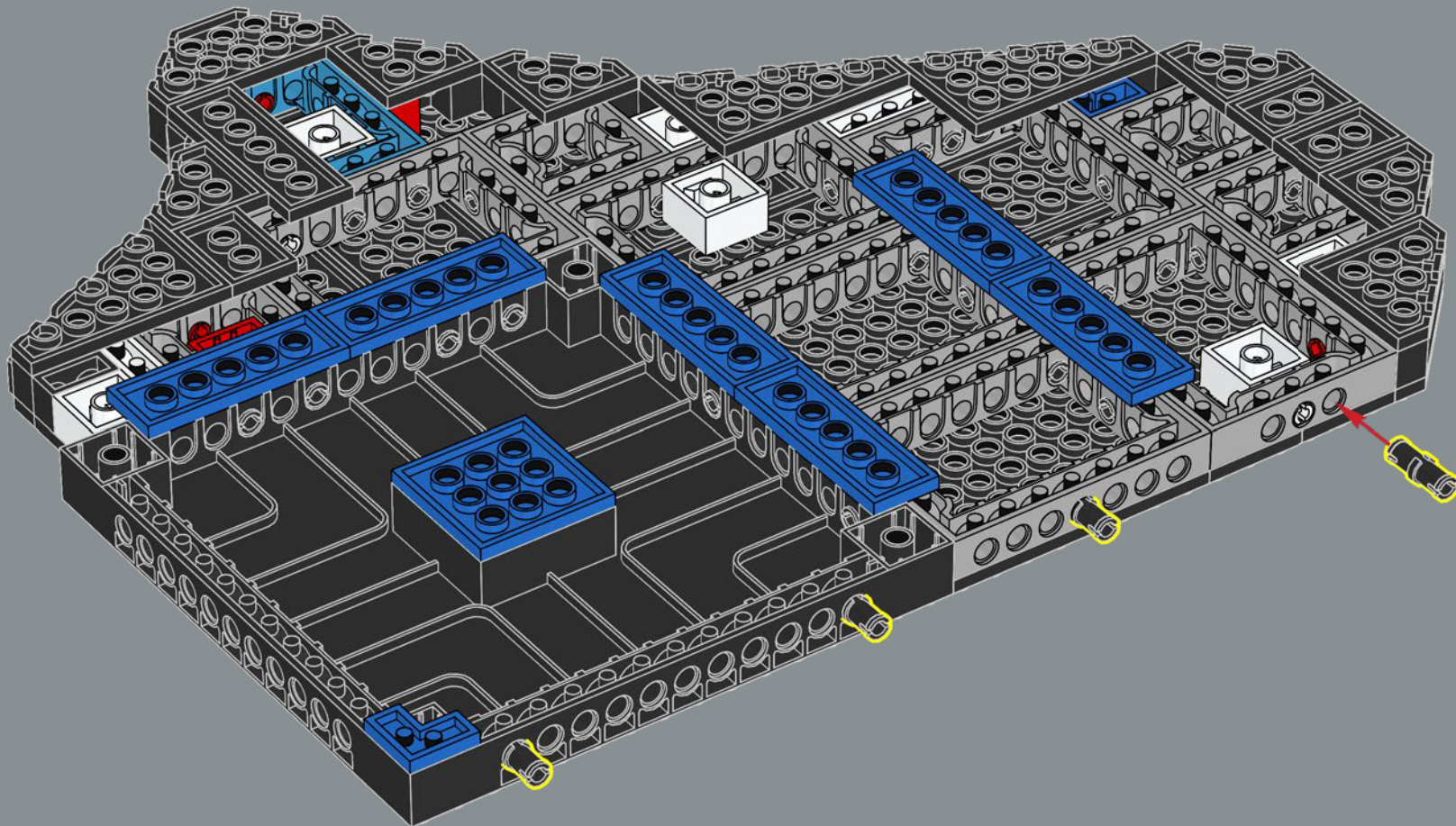

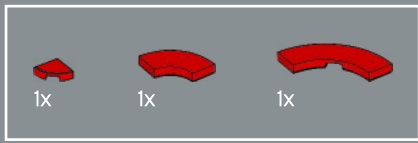

64

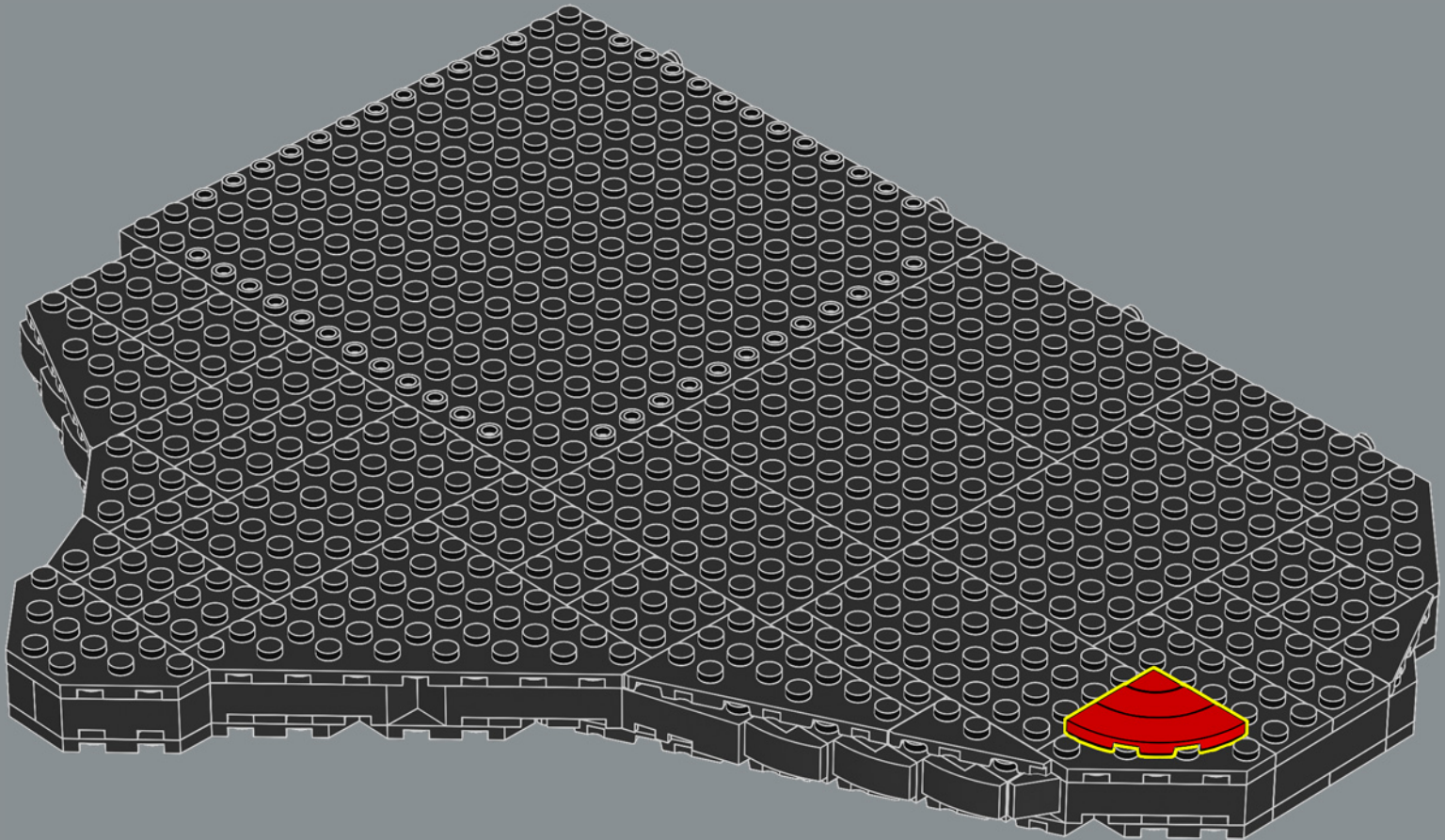



5x

65

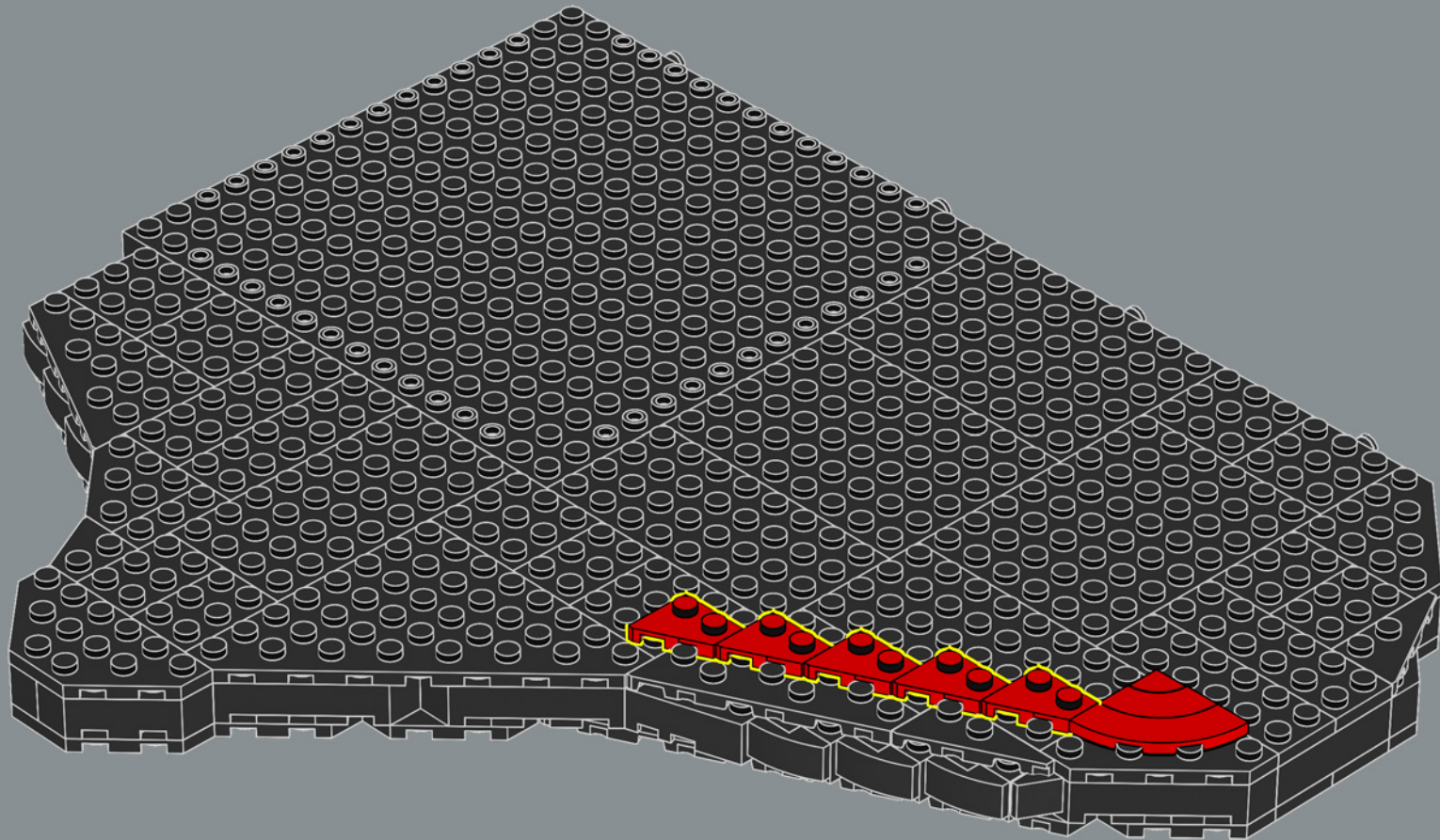

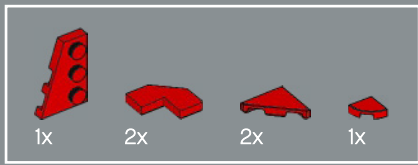

66

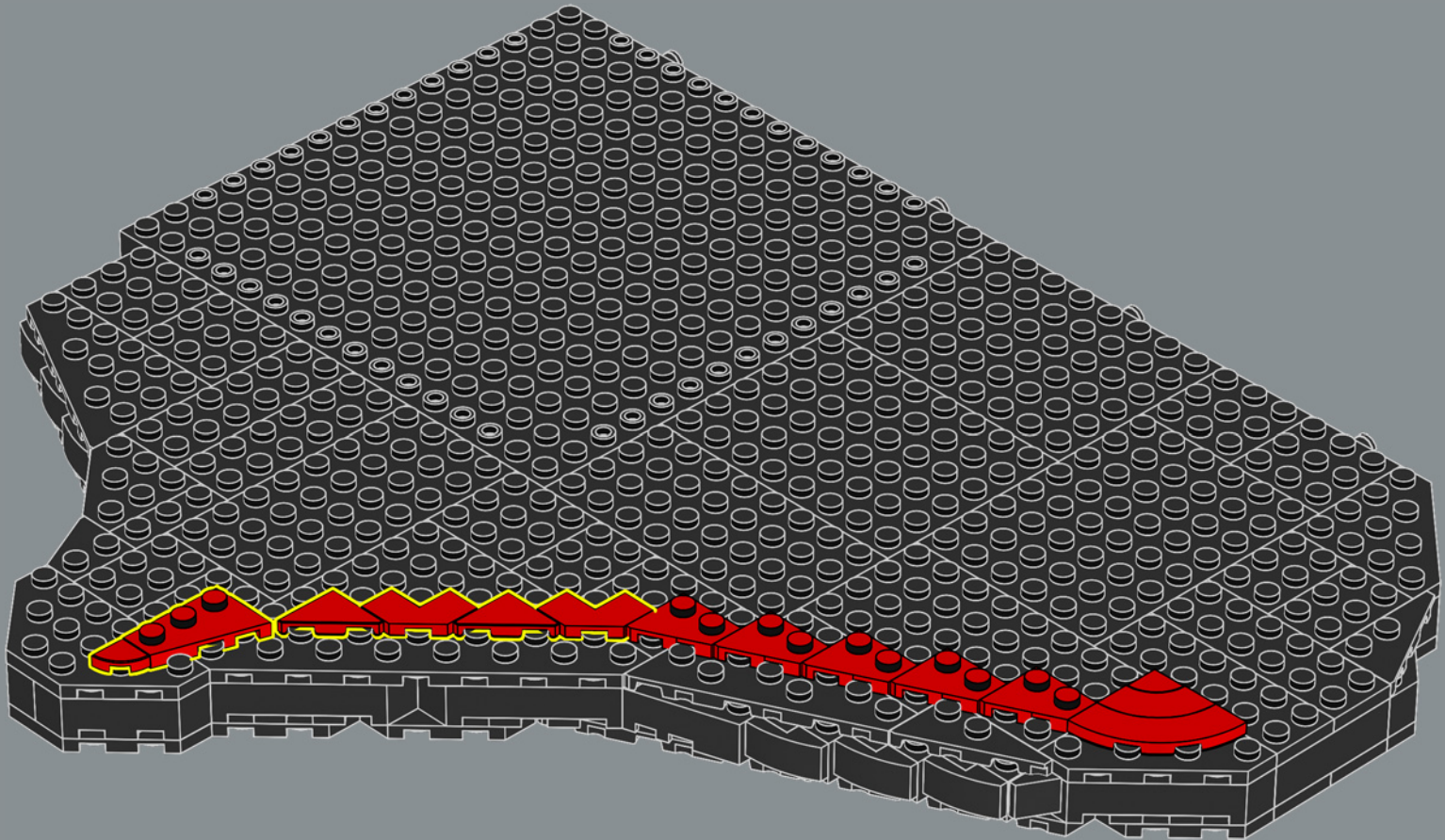

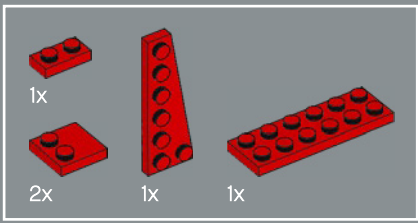

67

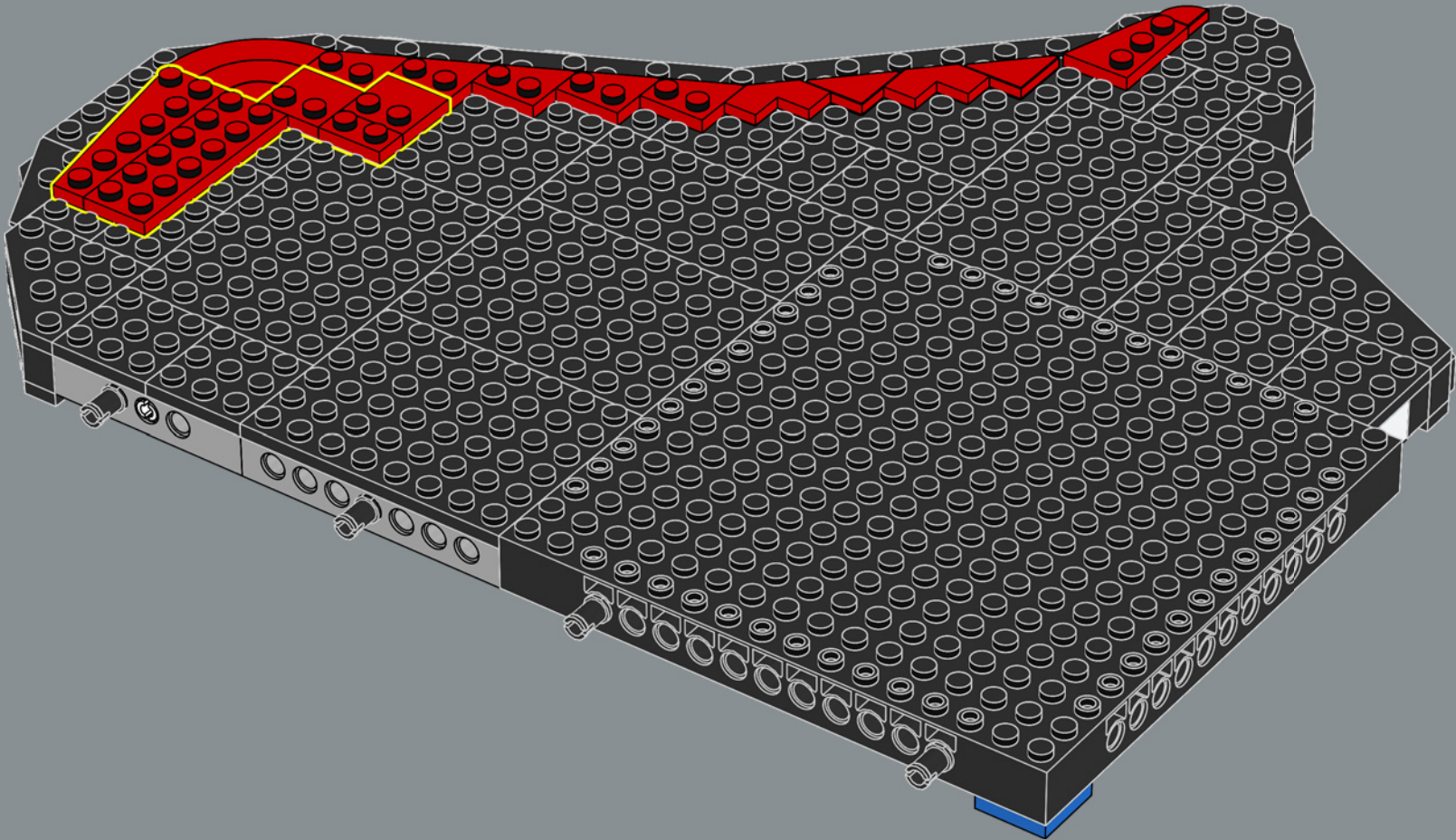

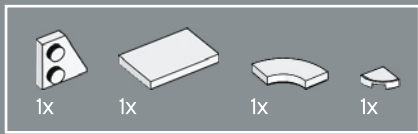

68

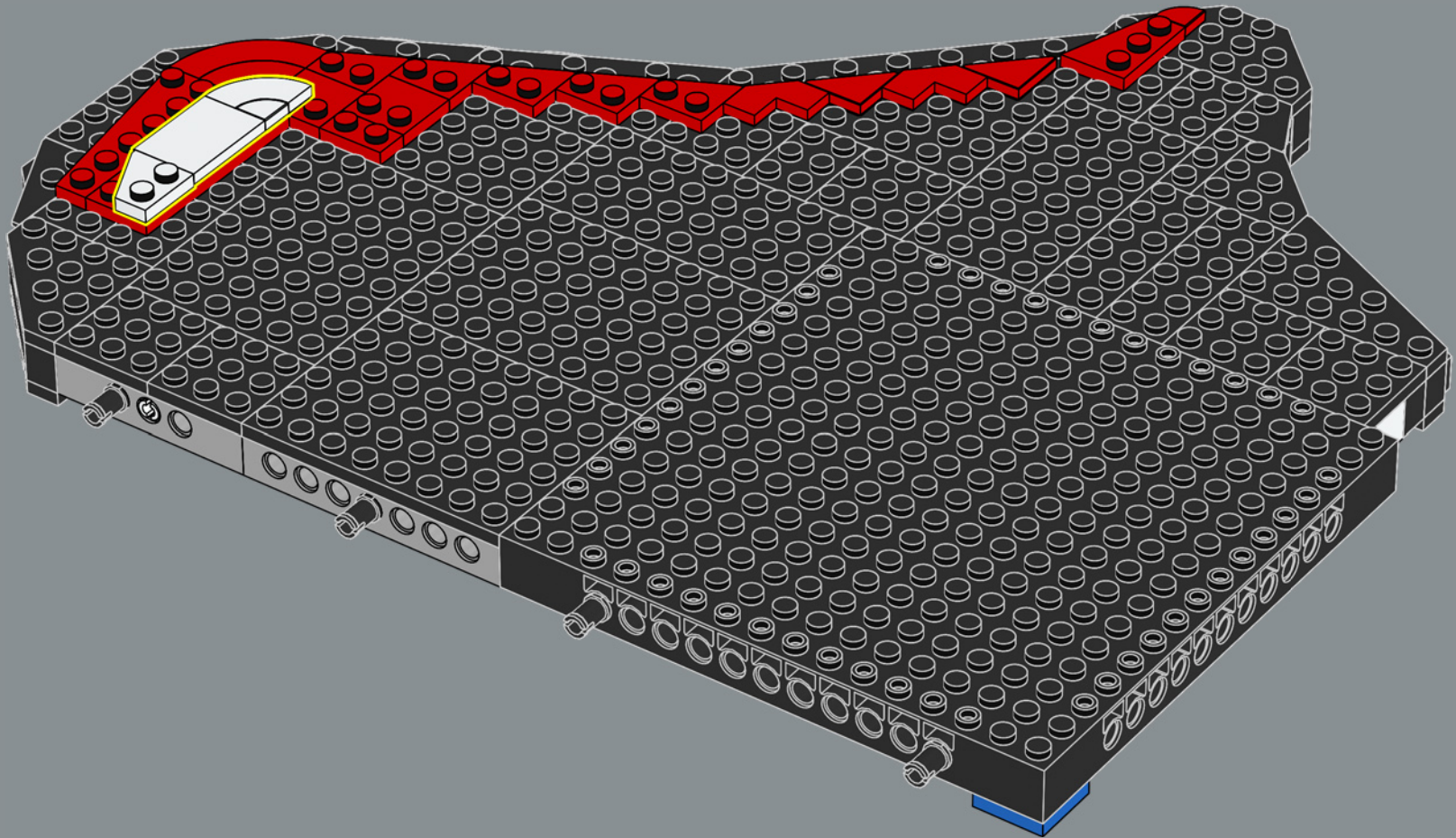

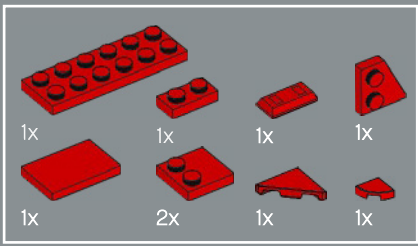

69

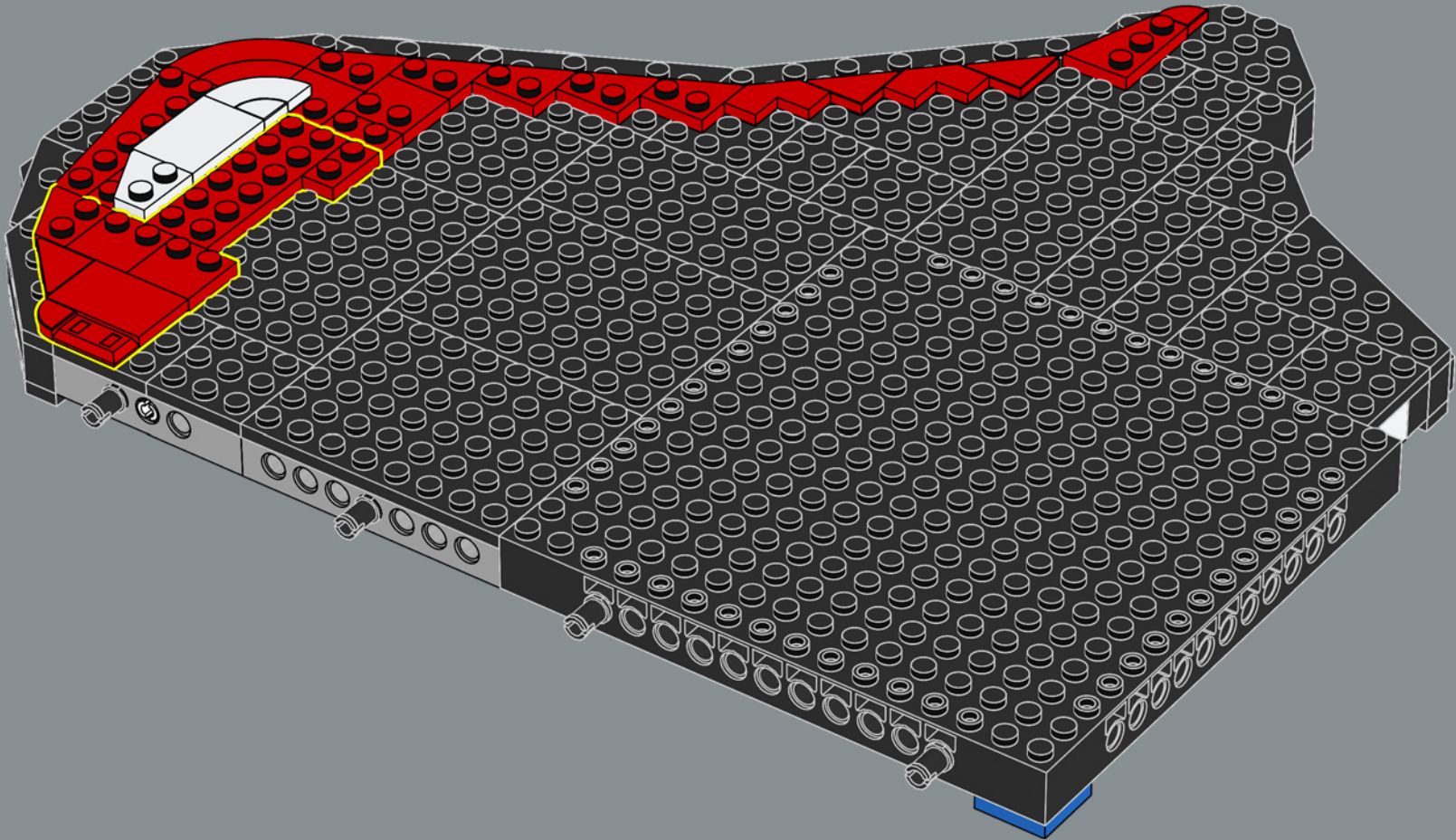

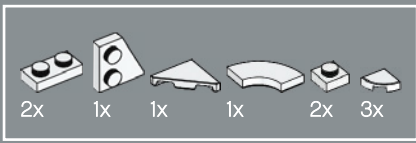

70

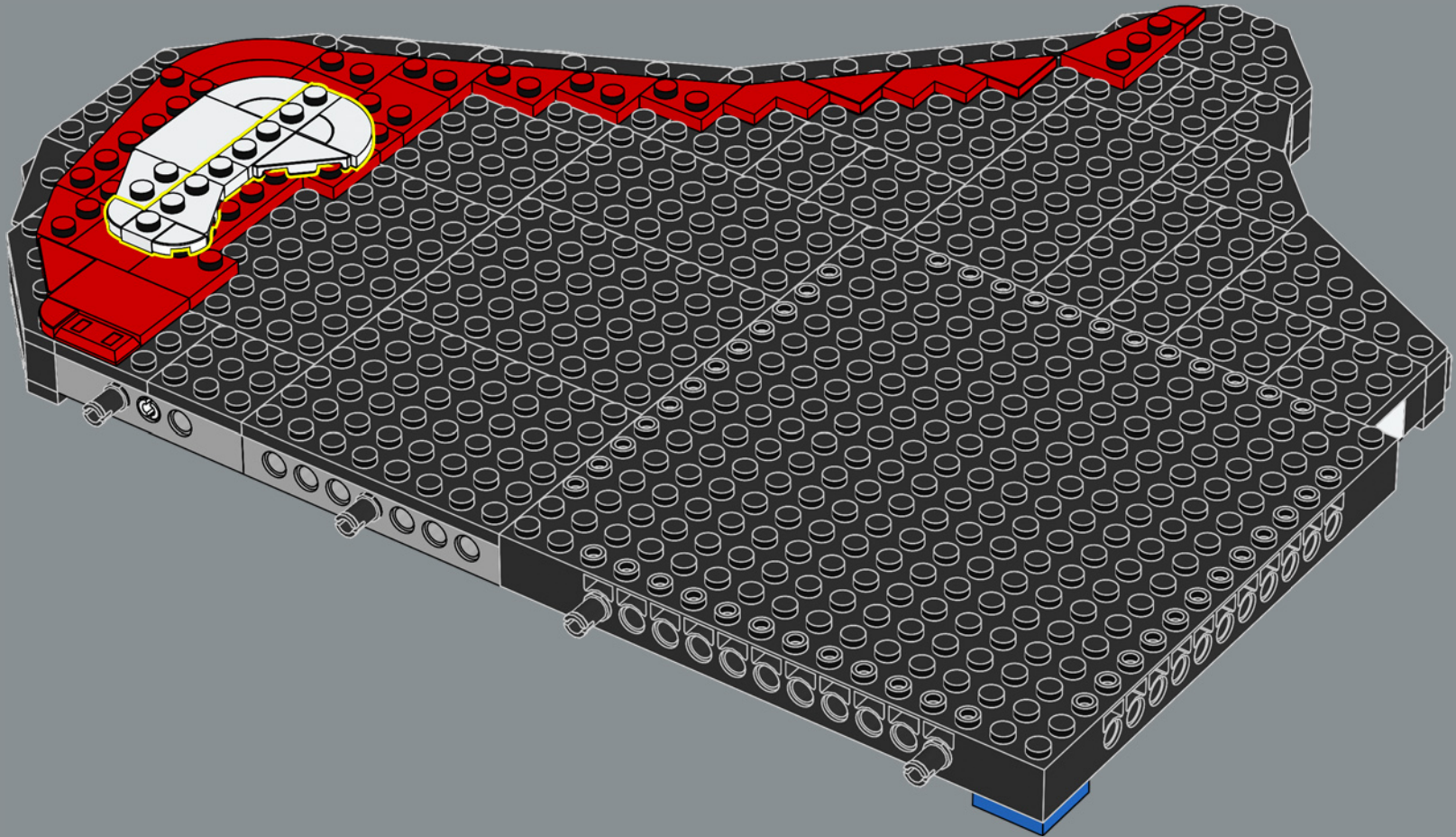

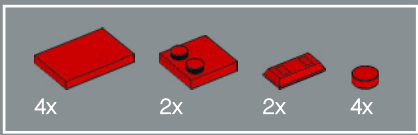

71

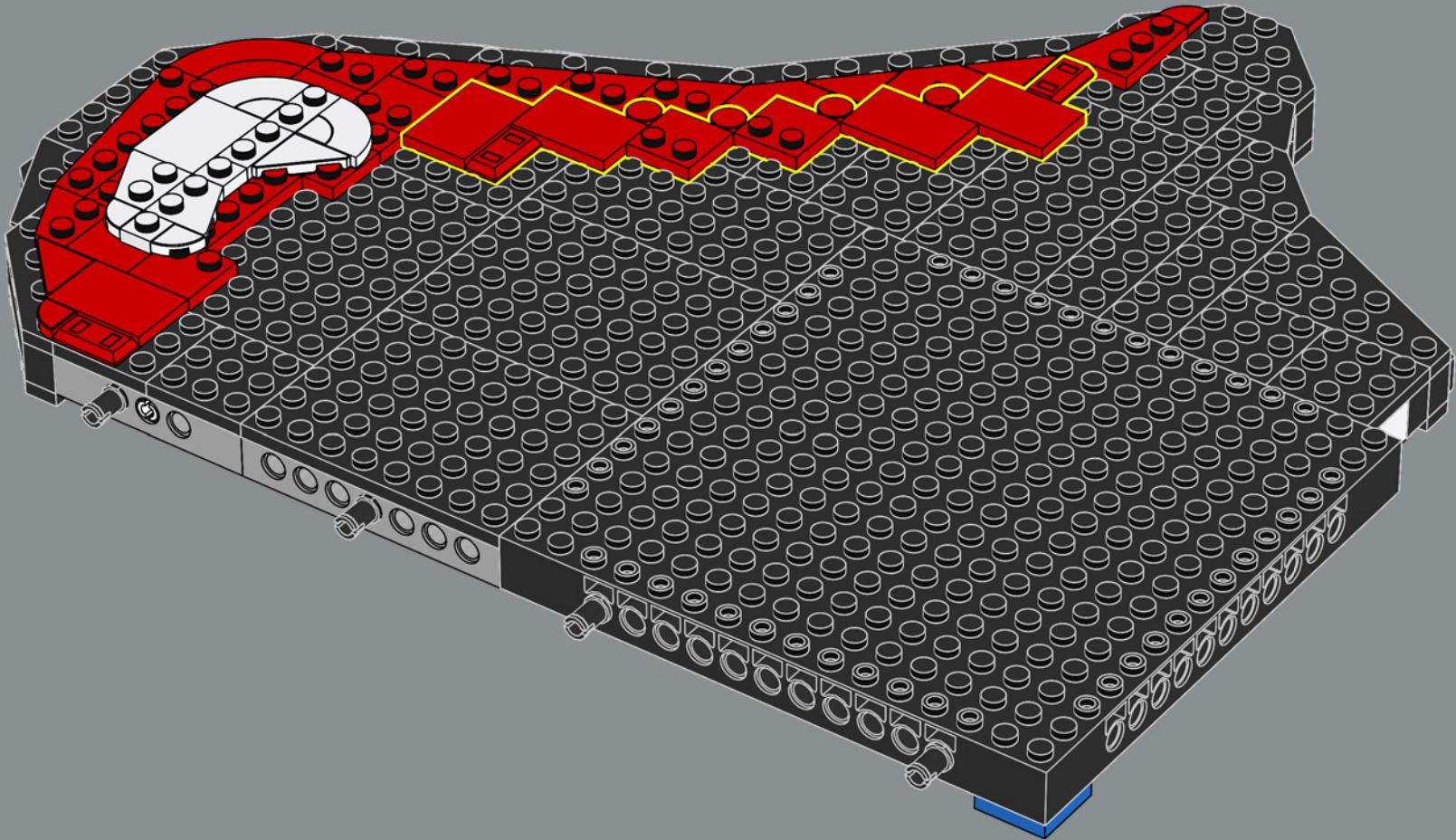

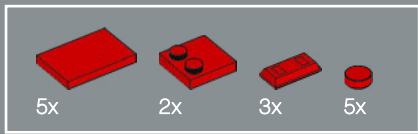

72

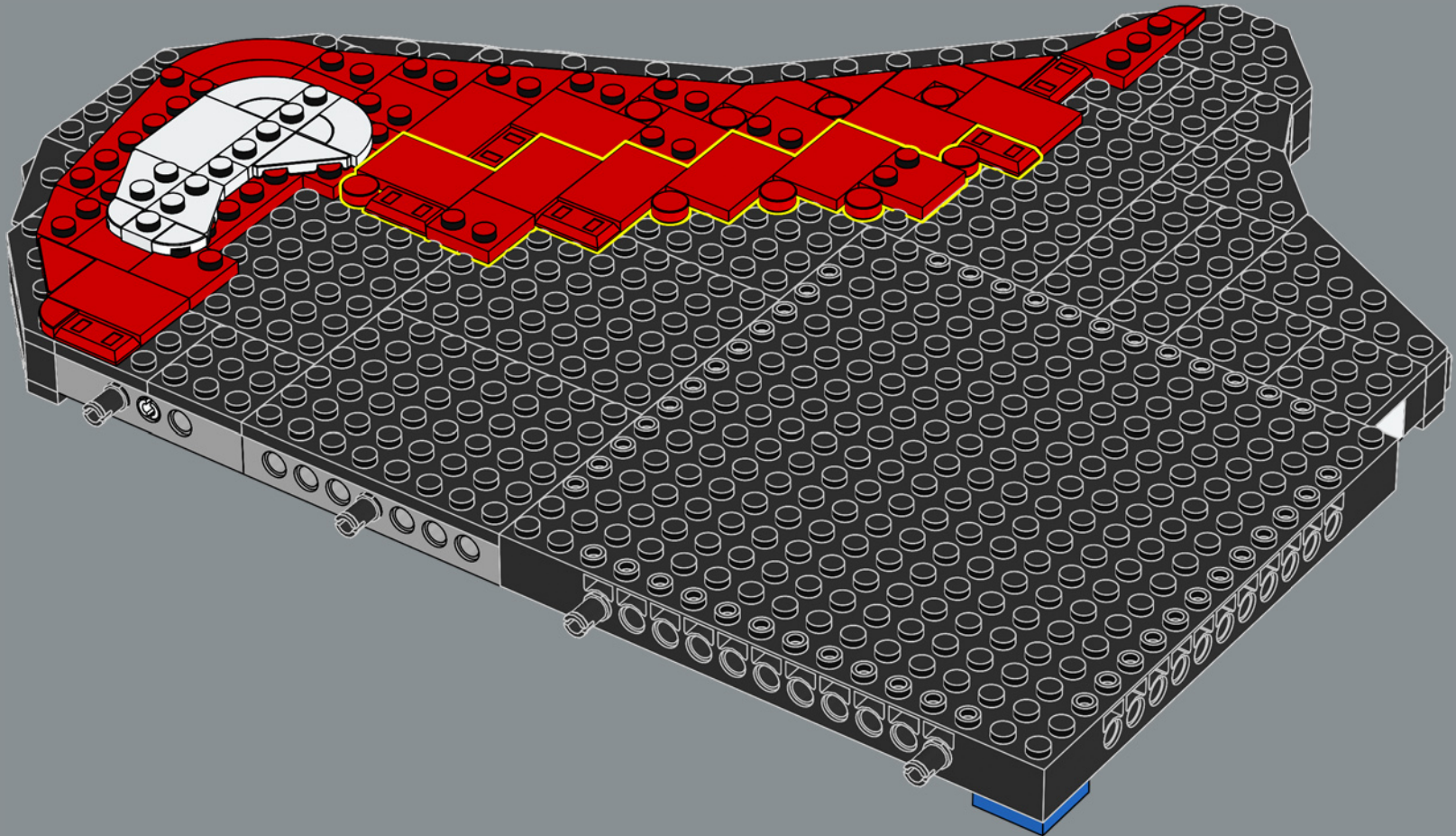

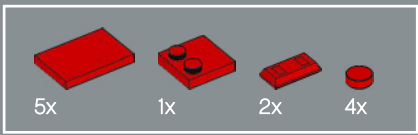

73

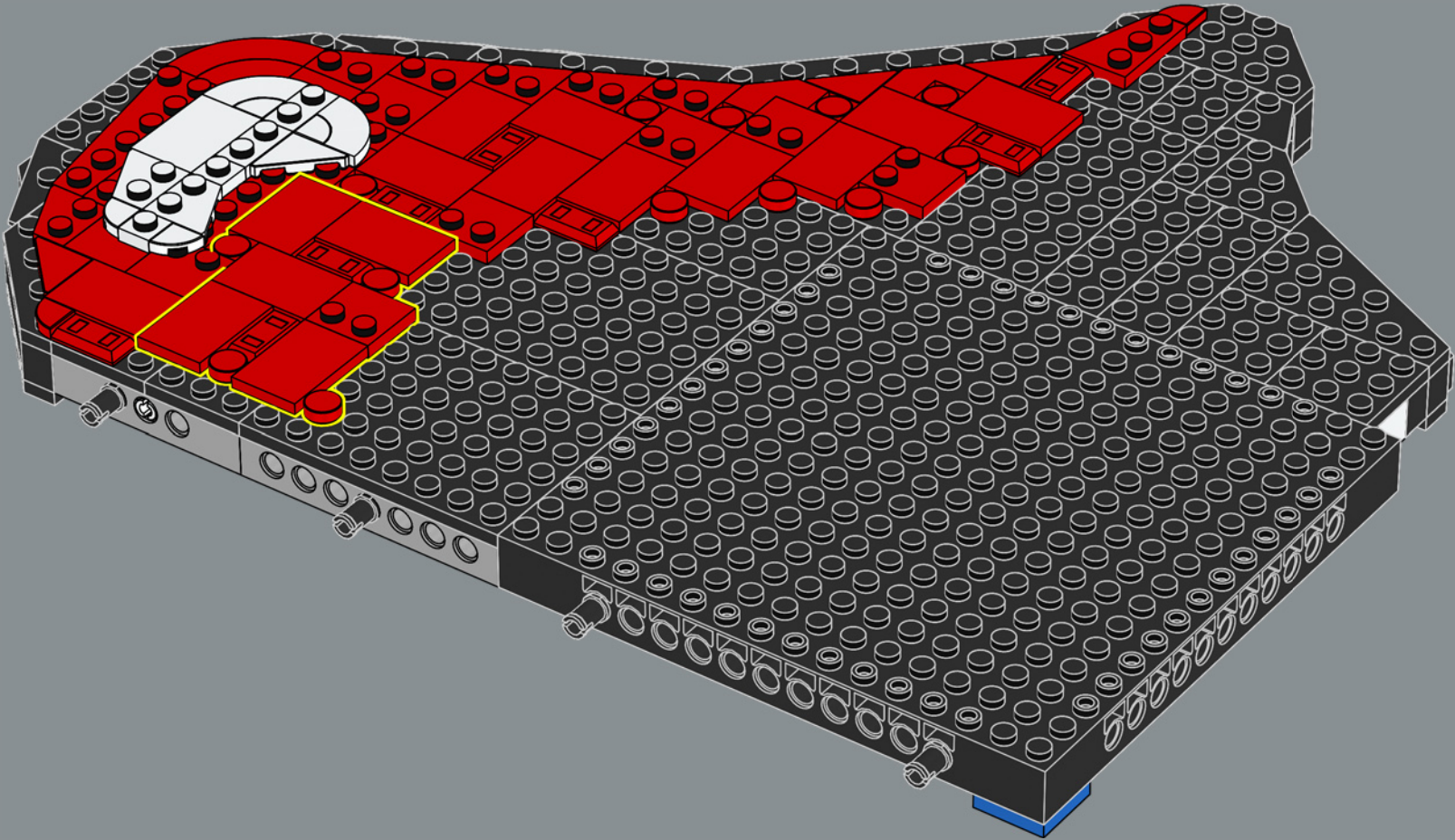

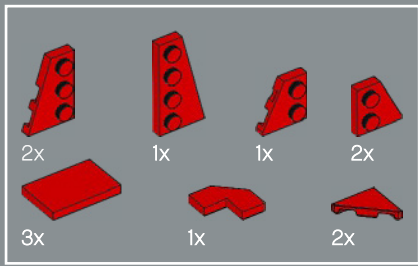

74

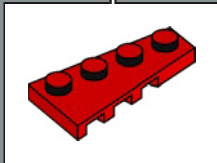
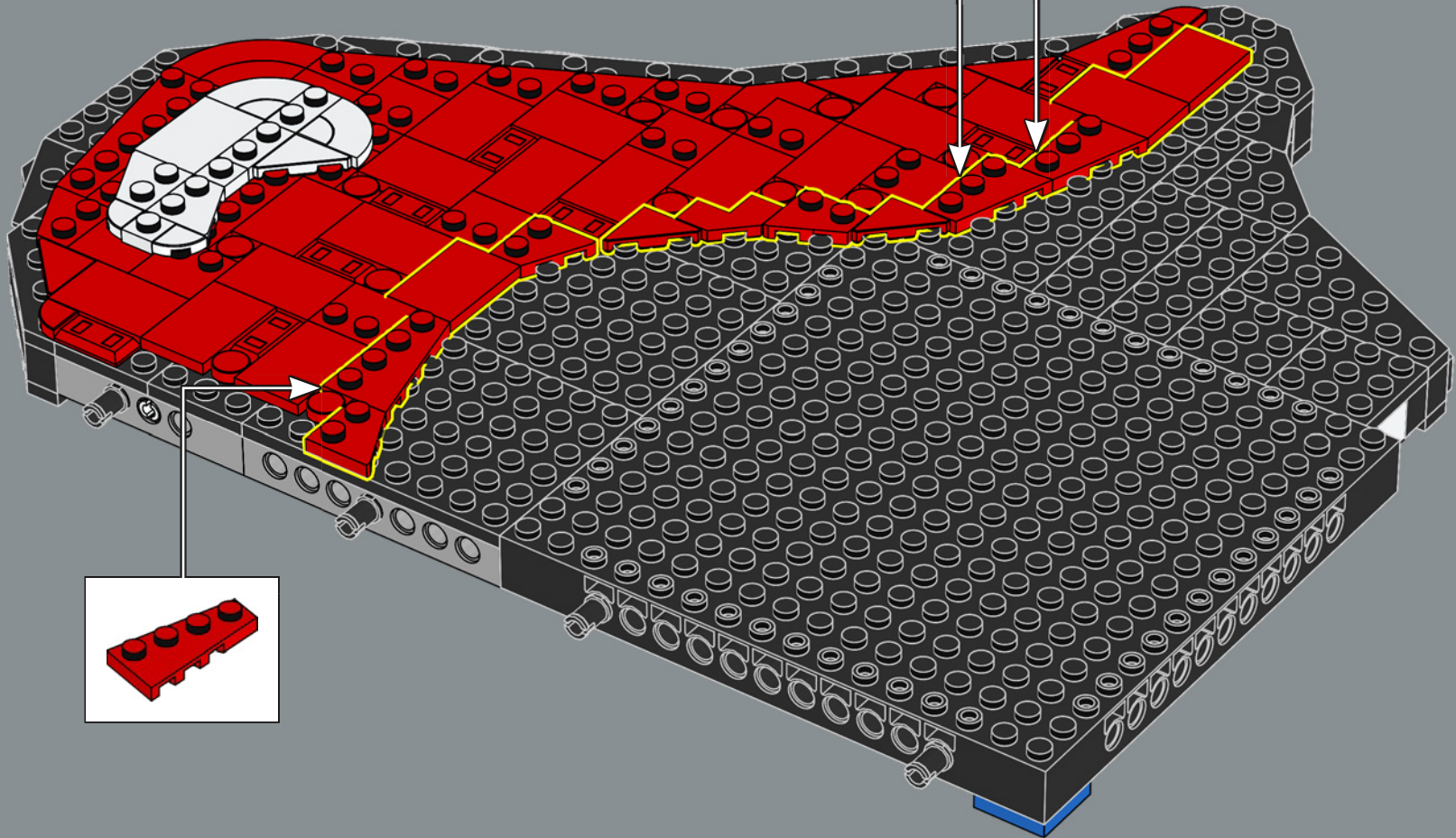
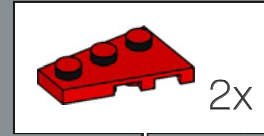

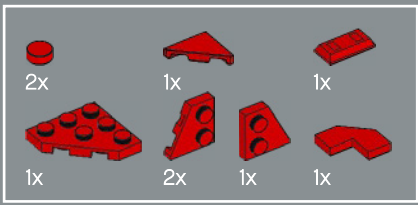

75

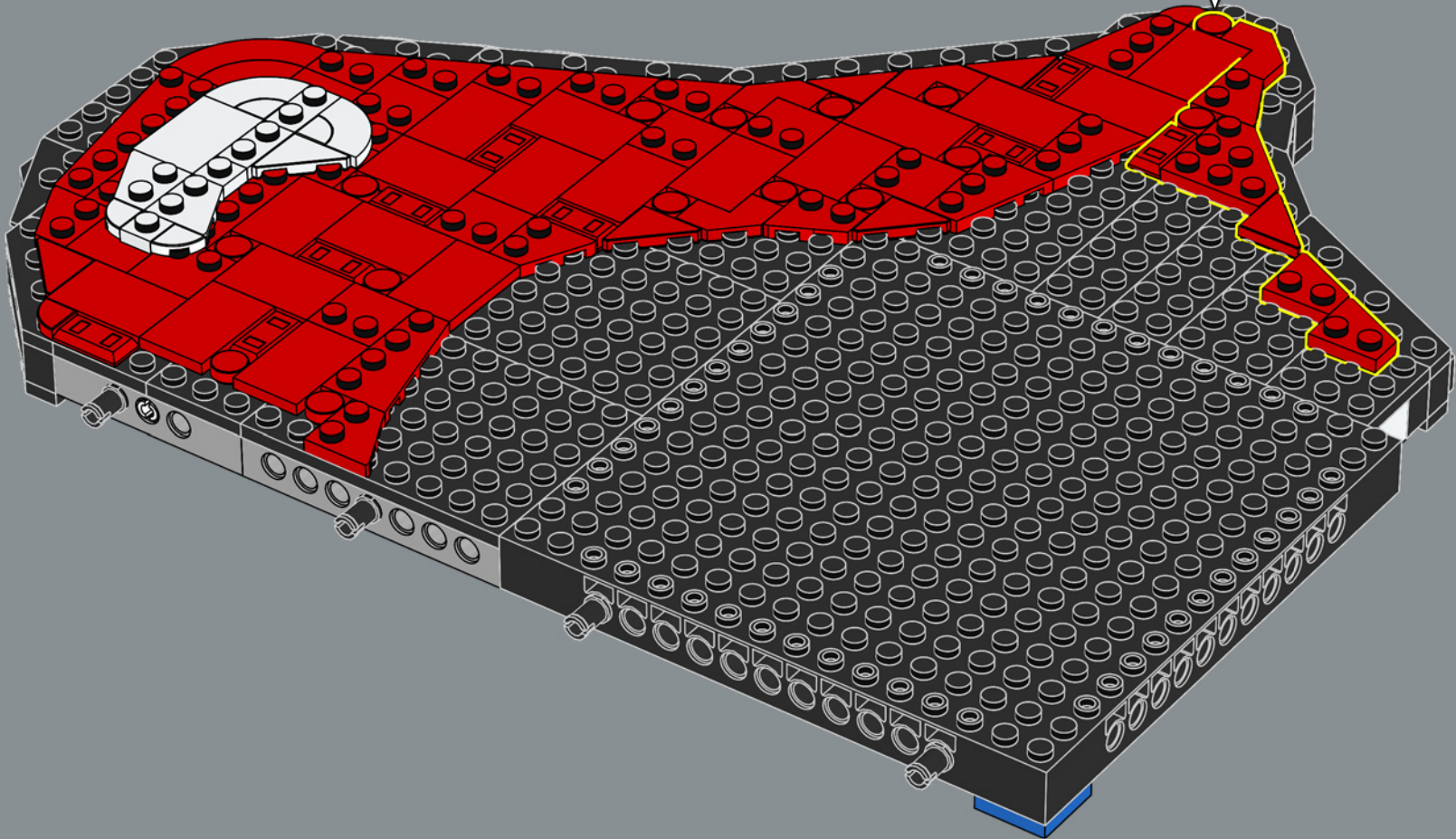

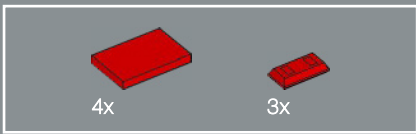

76

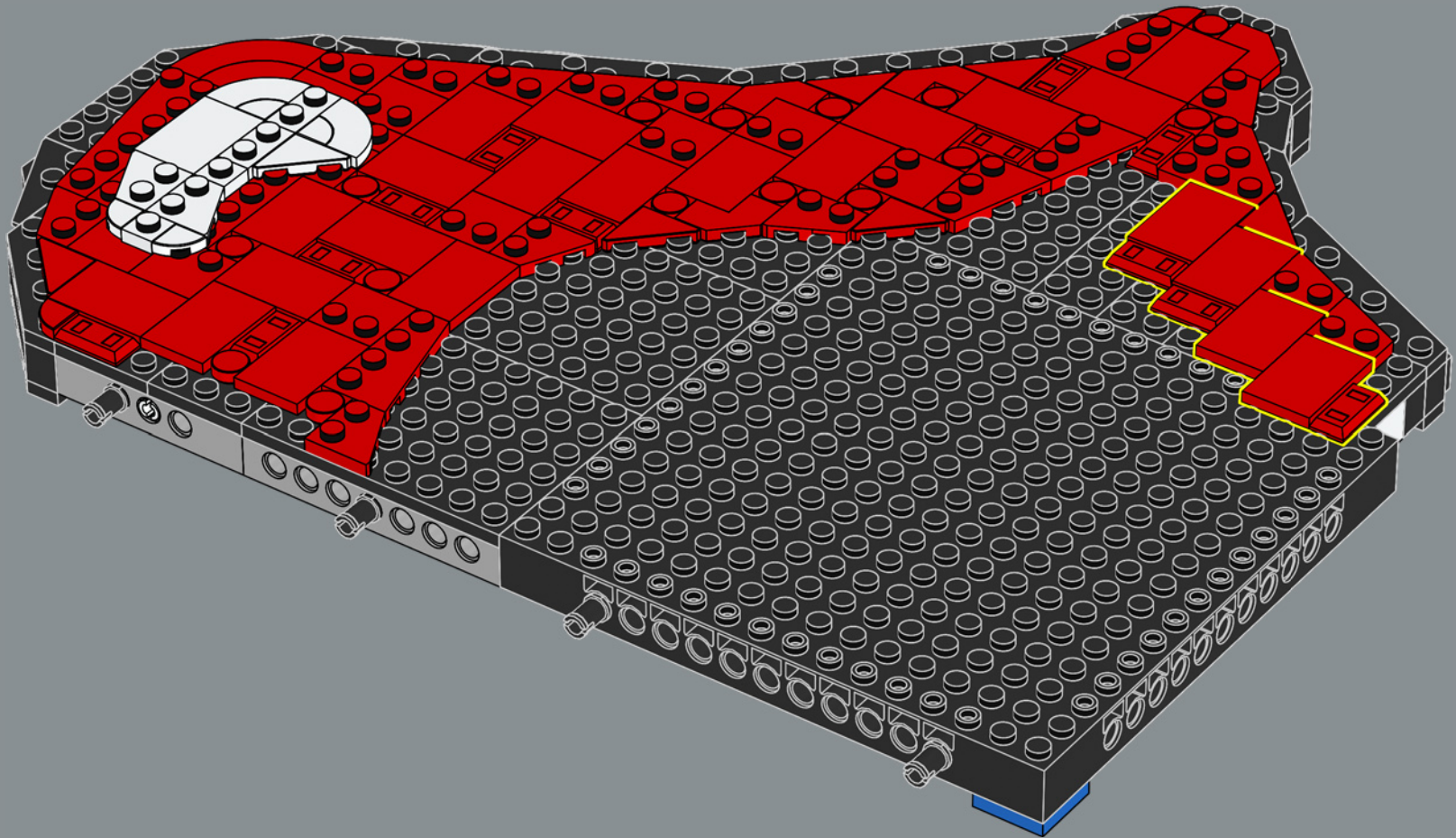

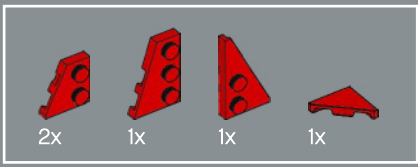

77

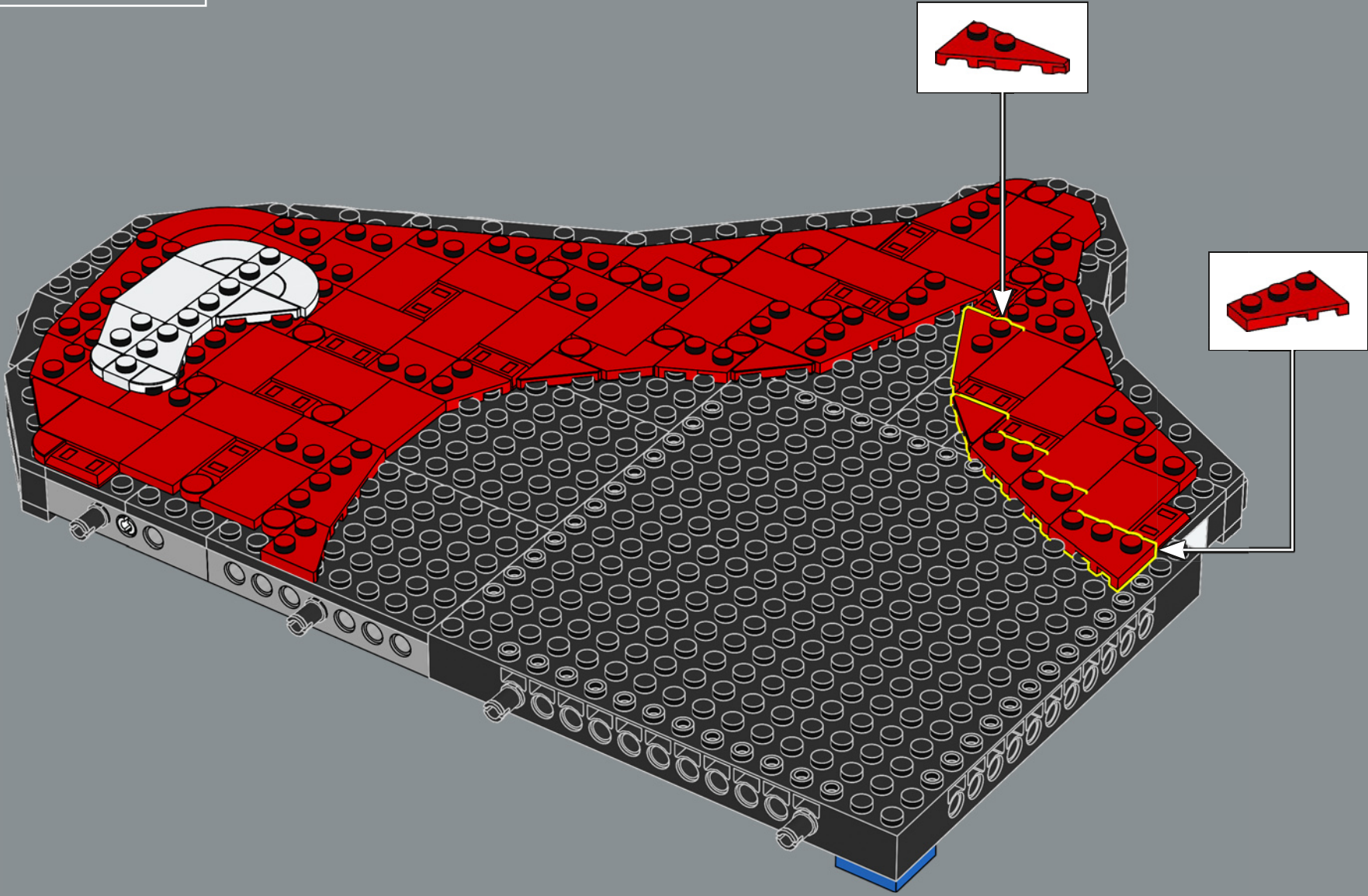

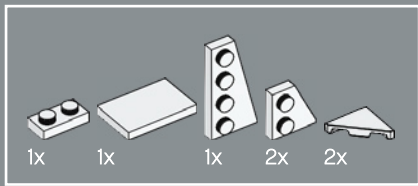

78

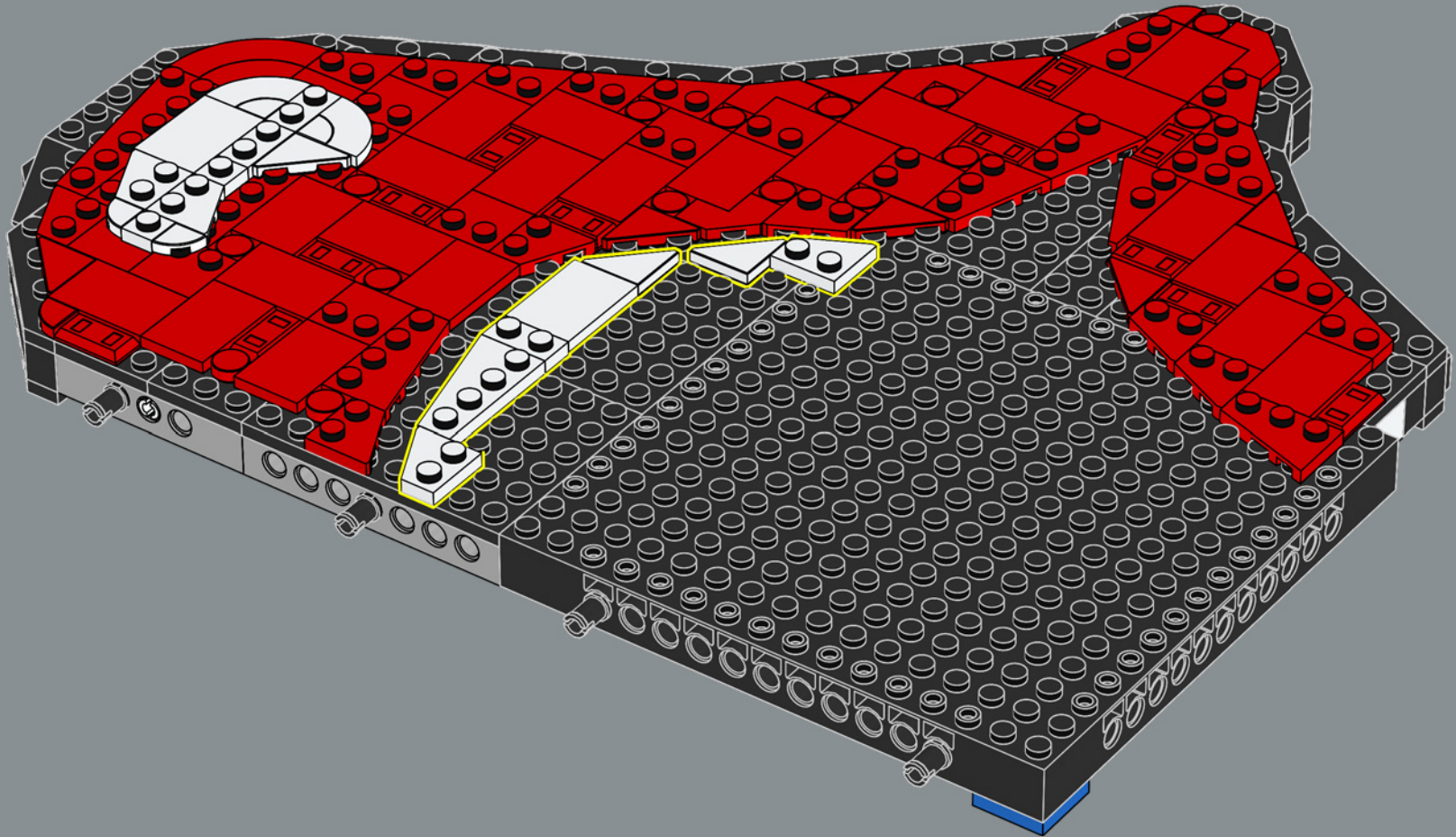

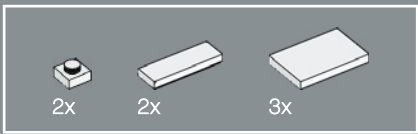

79

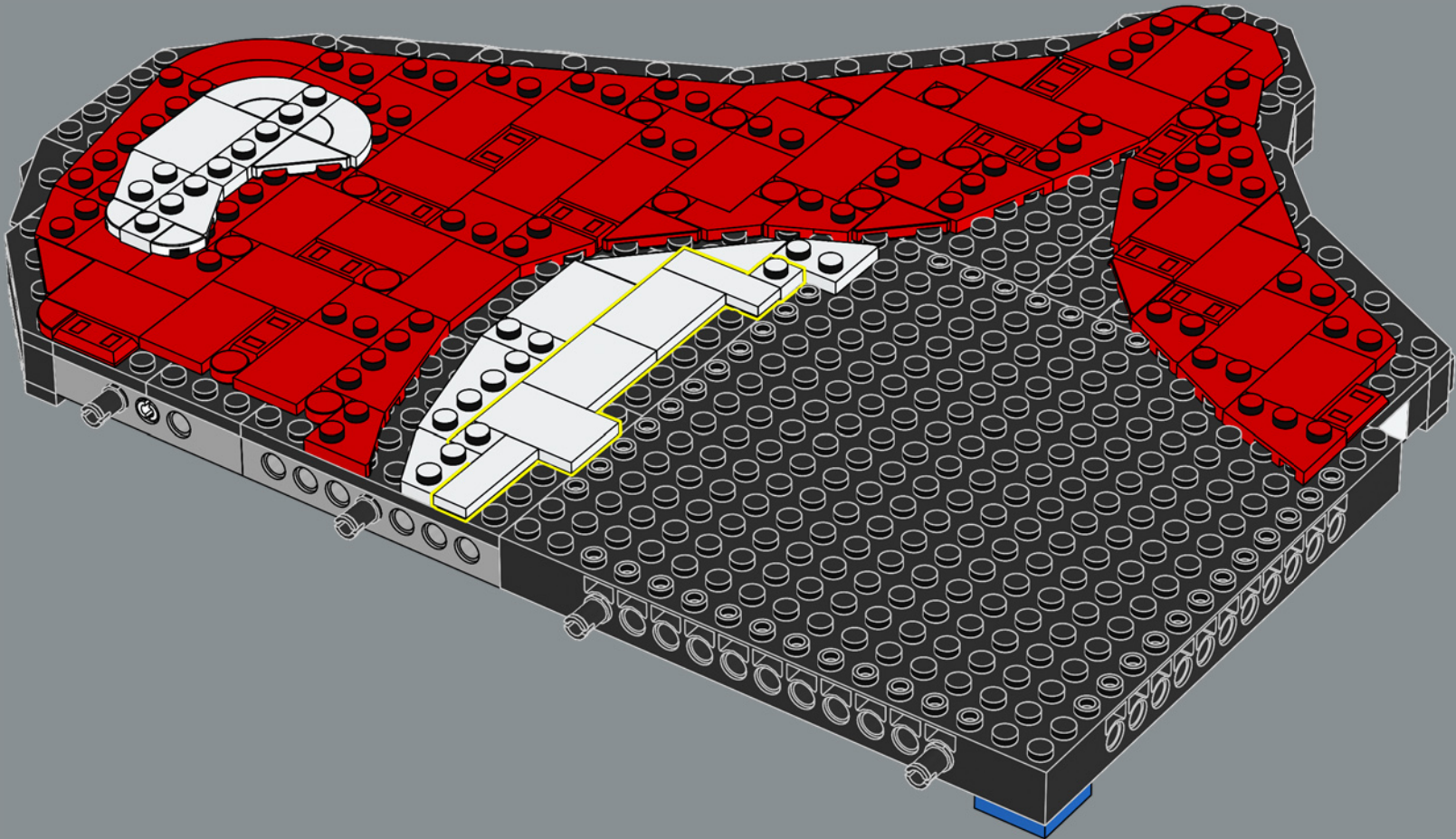

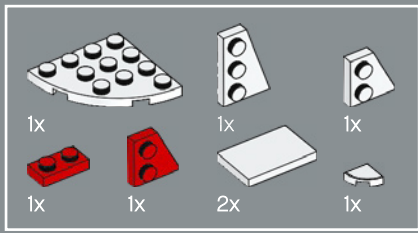

80

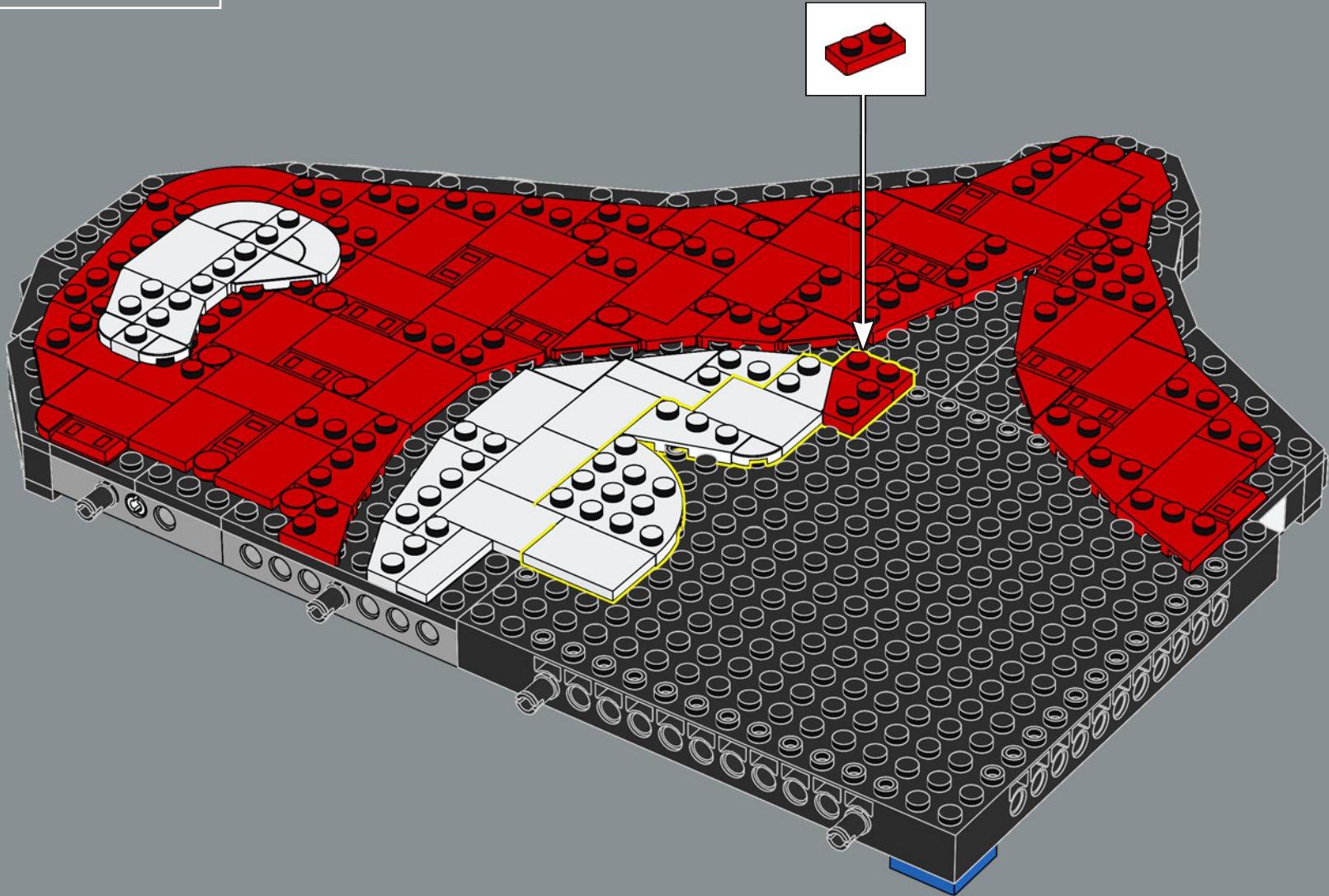

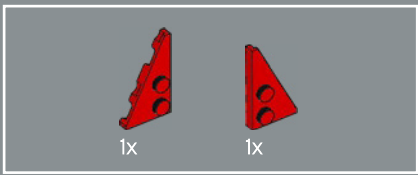

81

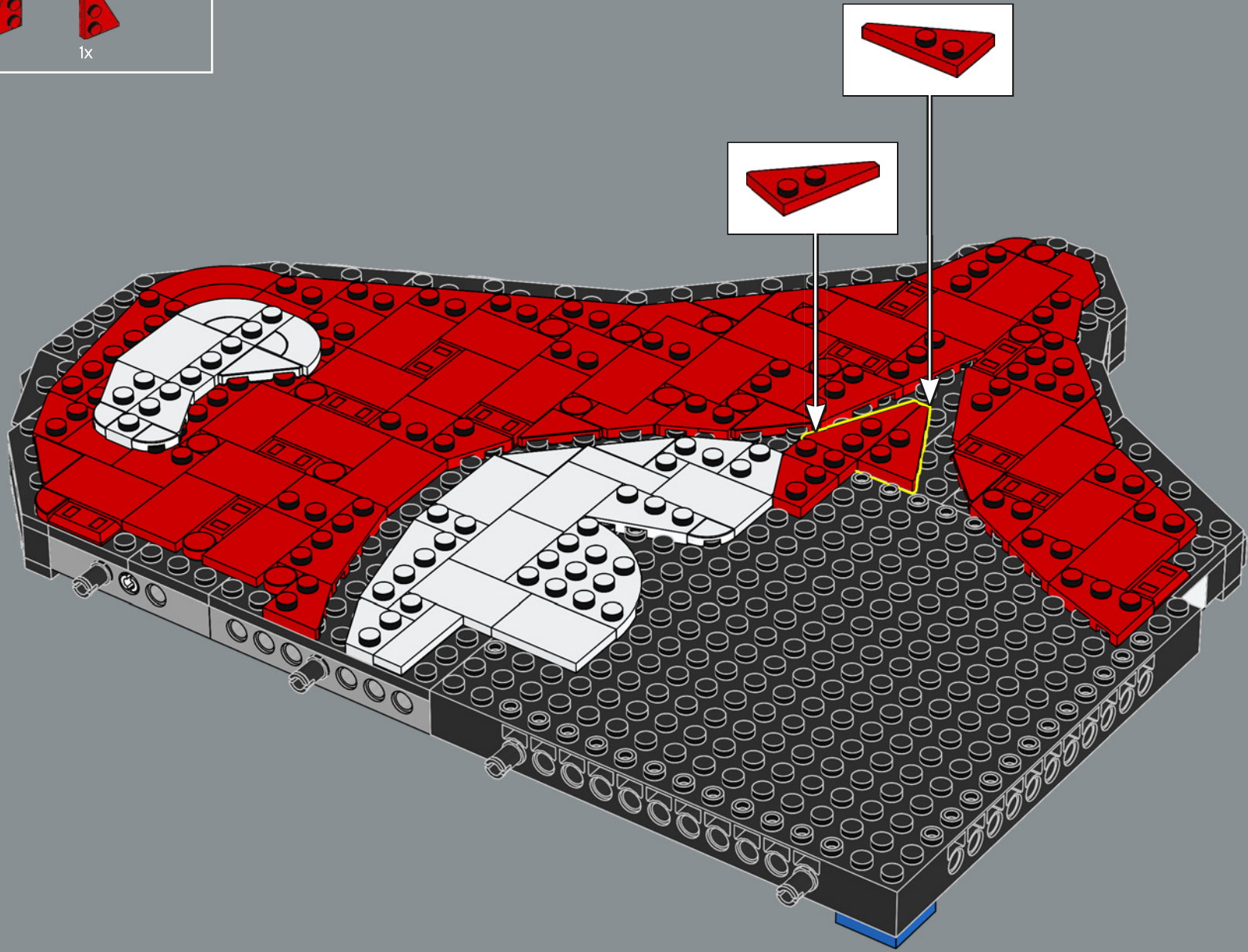

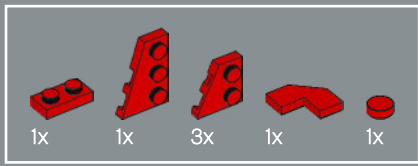

82

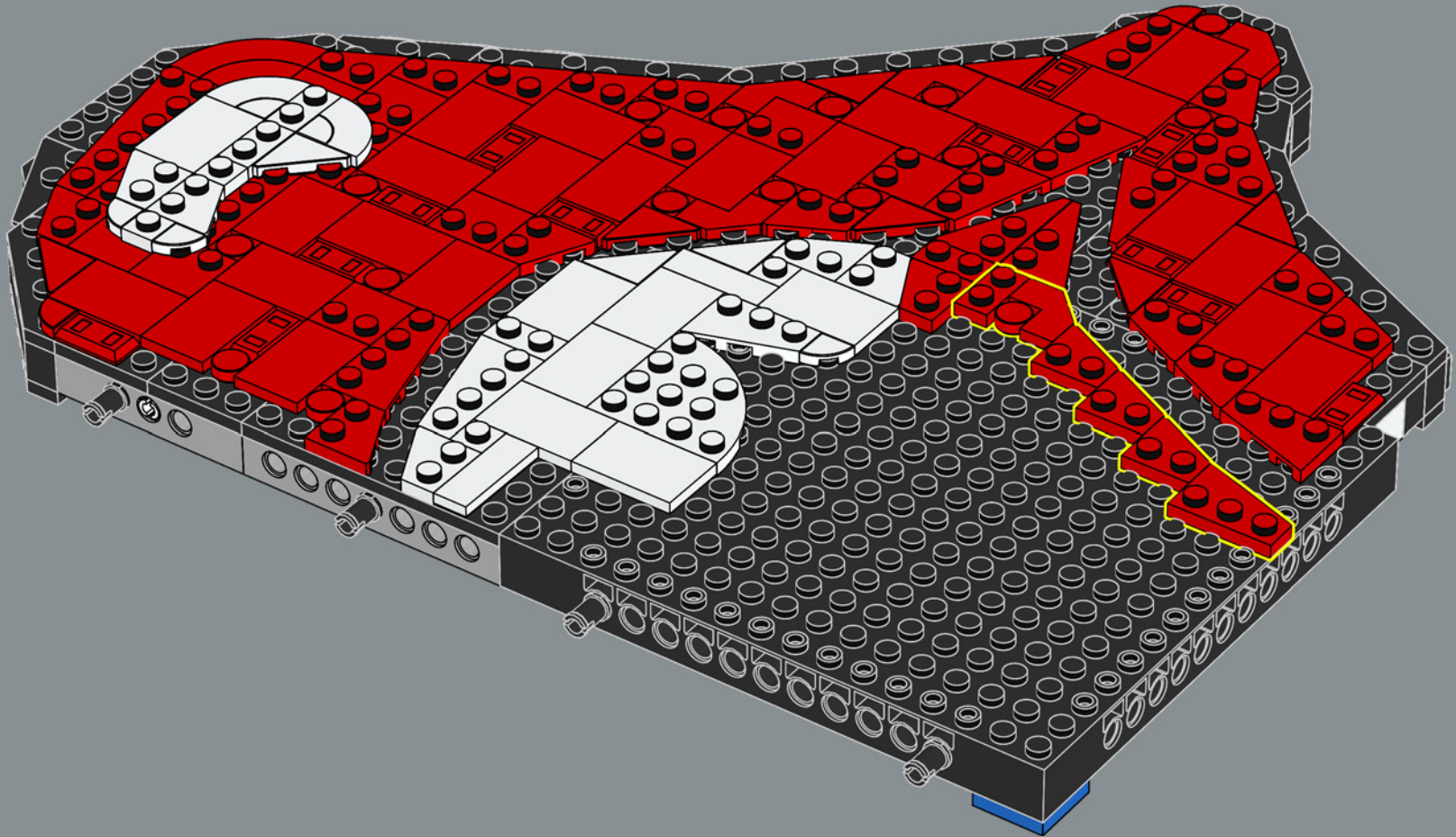

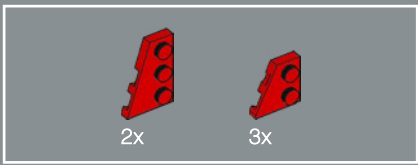

83

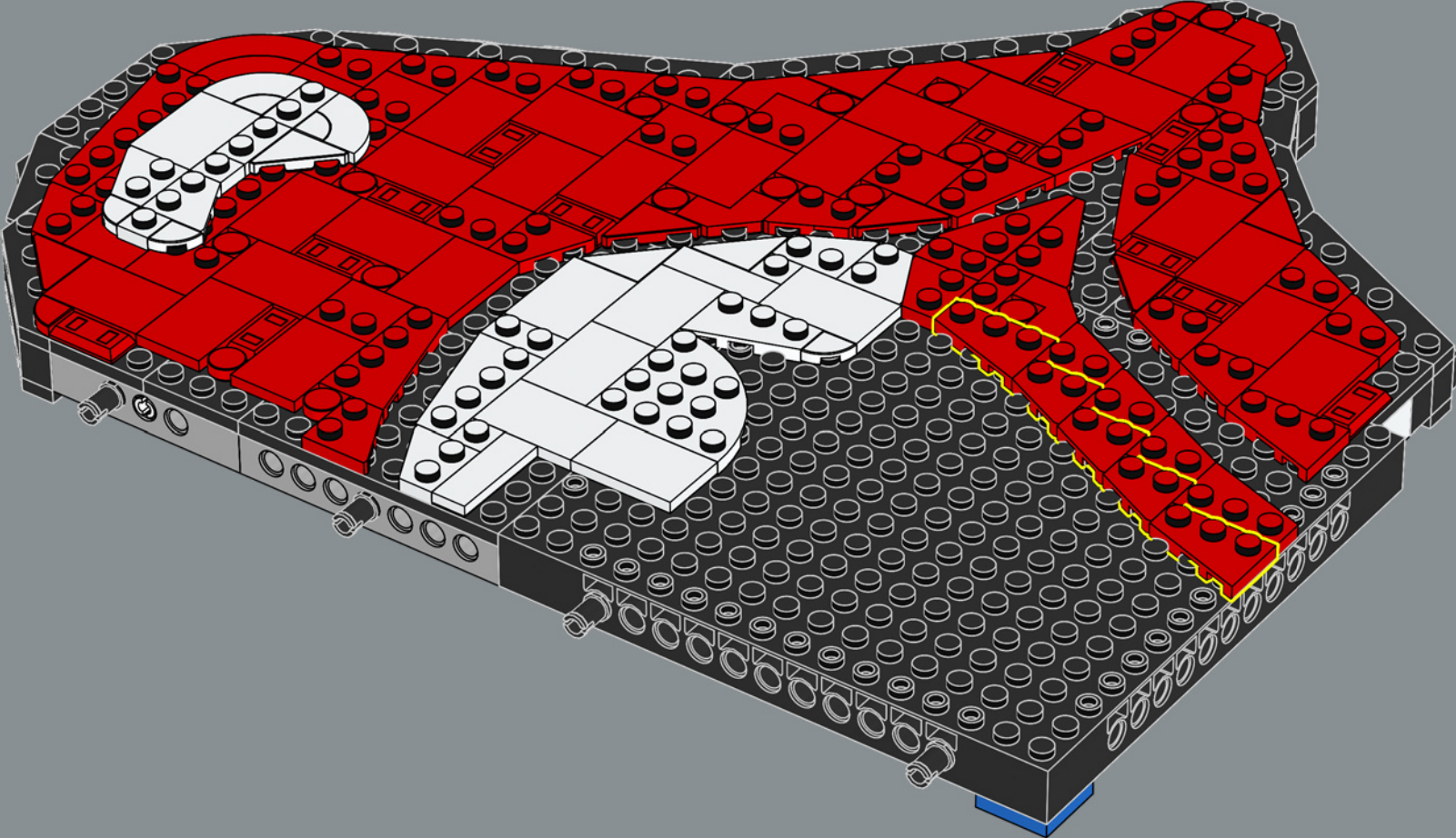

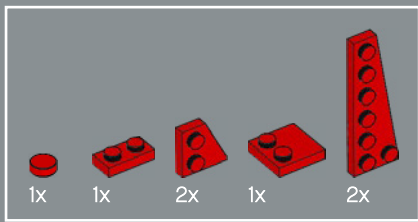

84

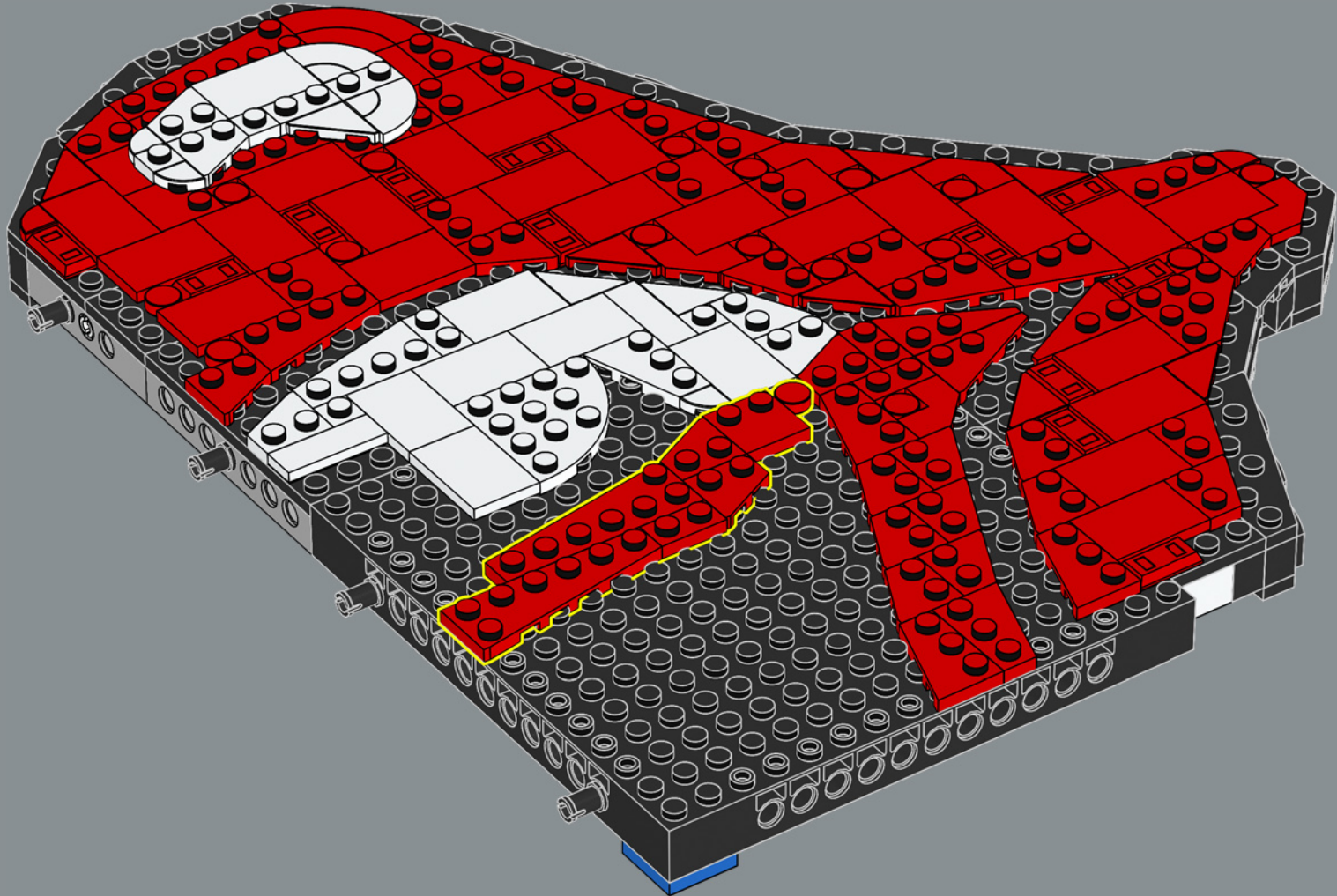

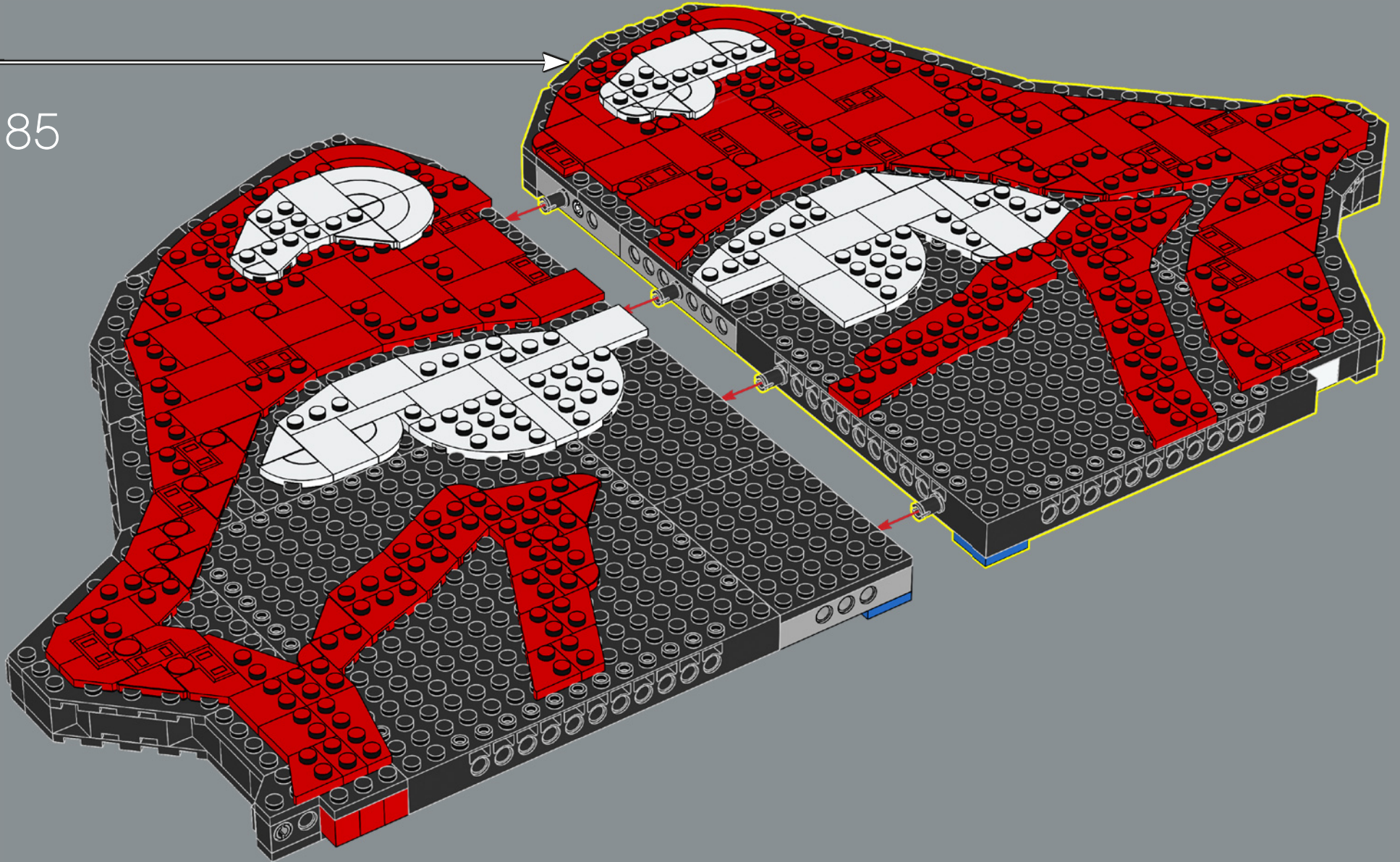

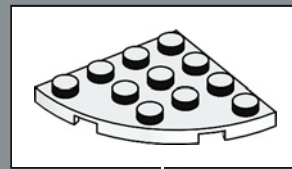
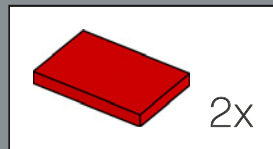
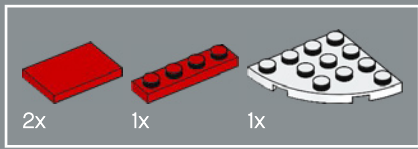

86

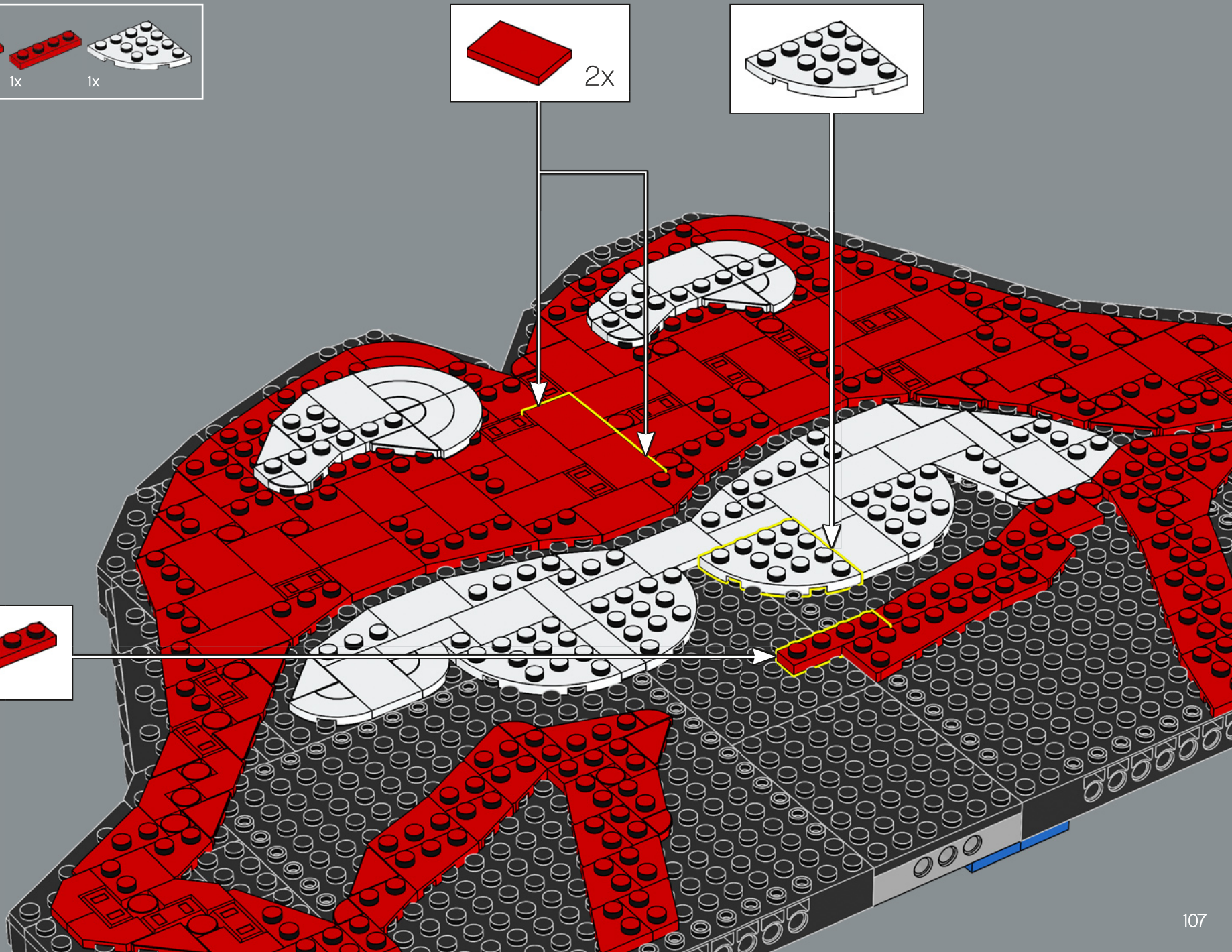
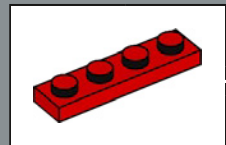

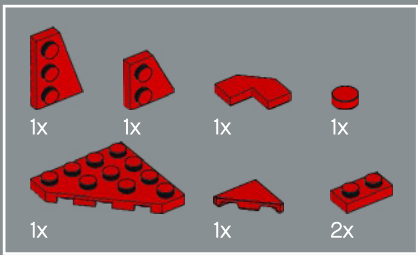

87

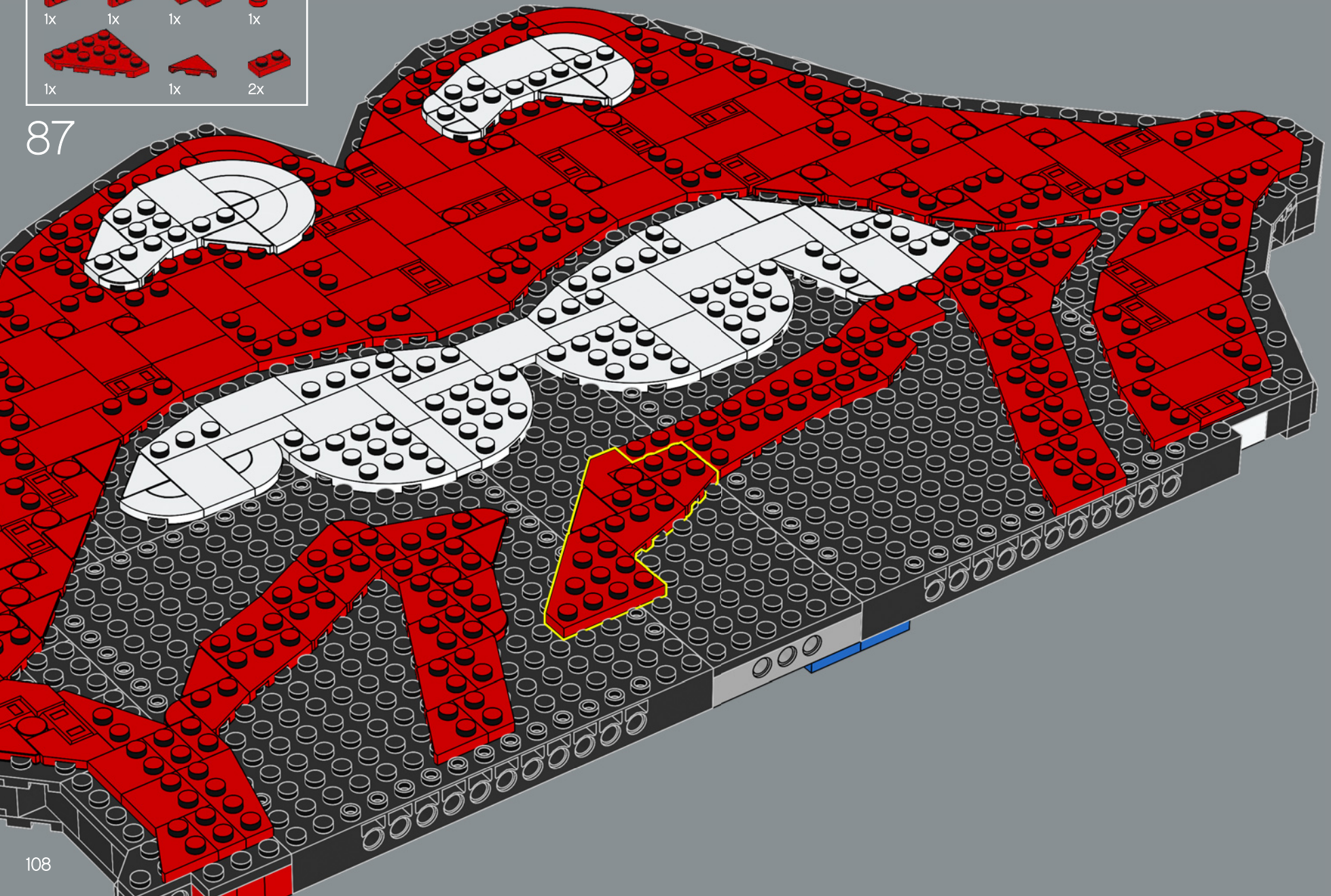

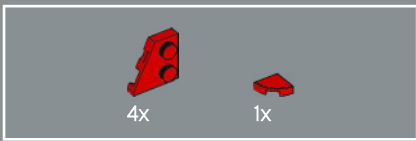

88

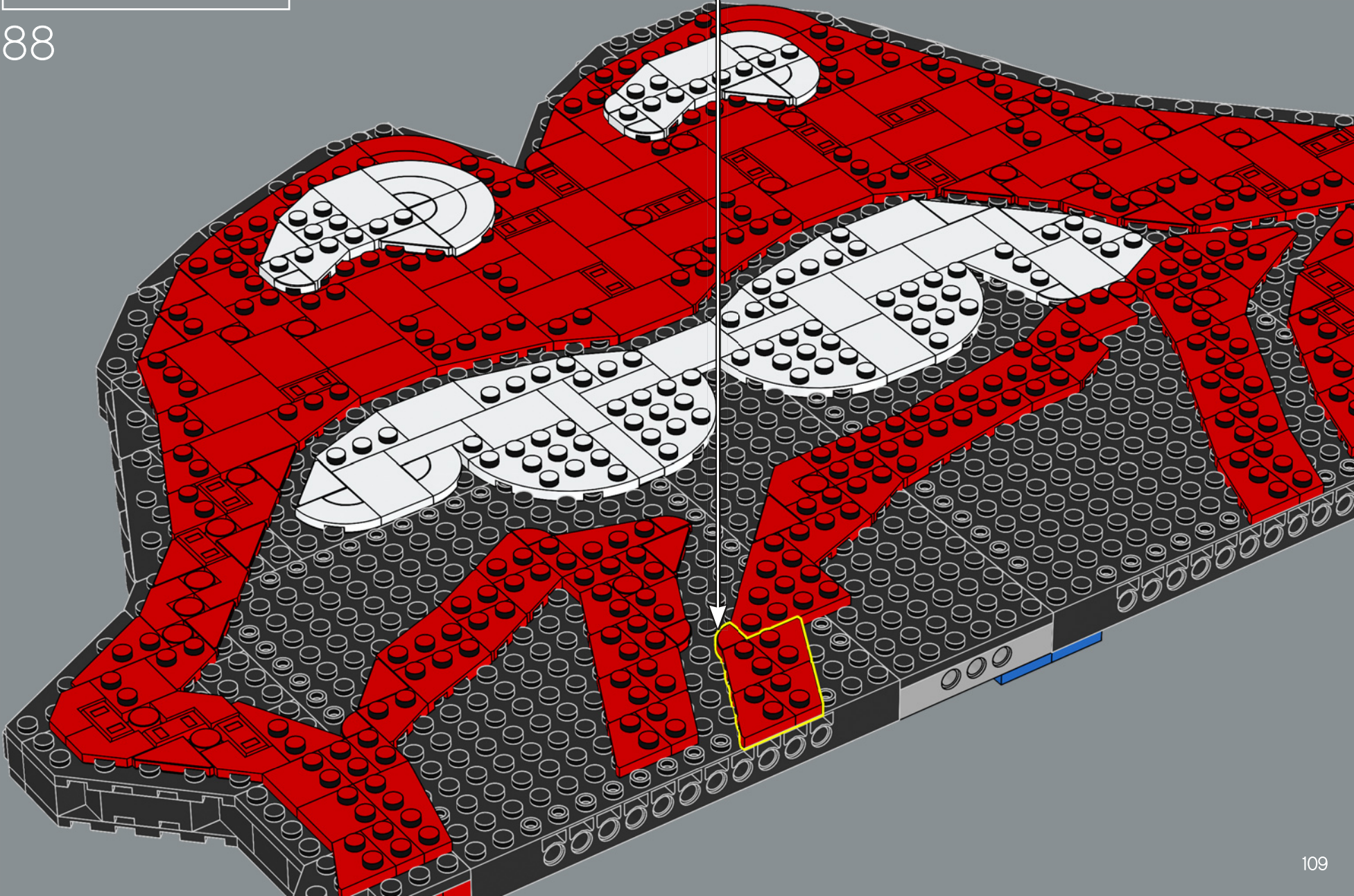

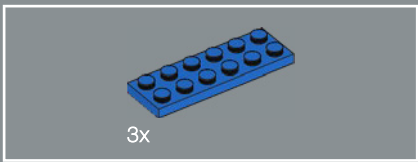

89

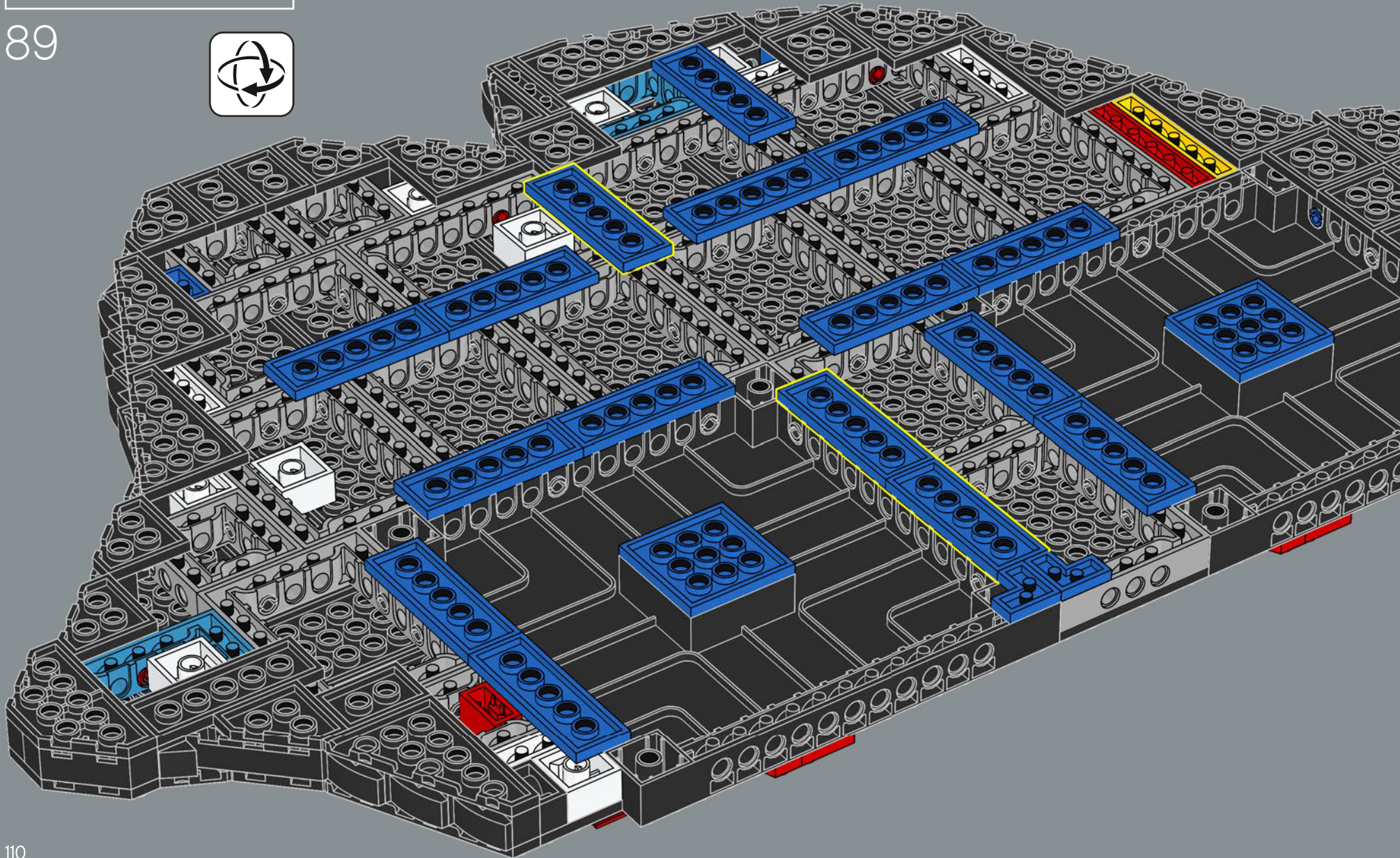

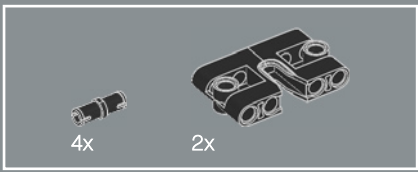

90

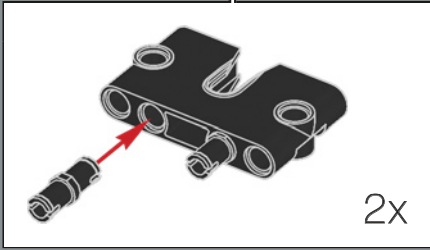
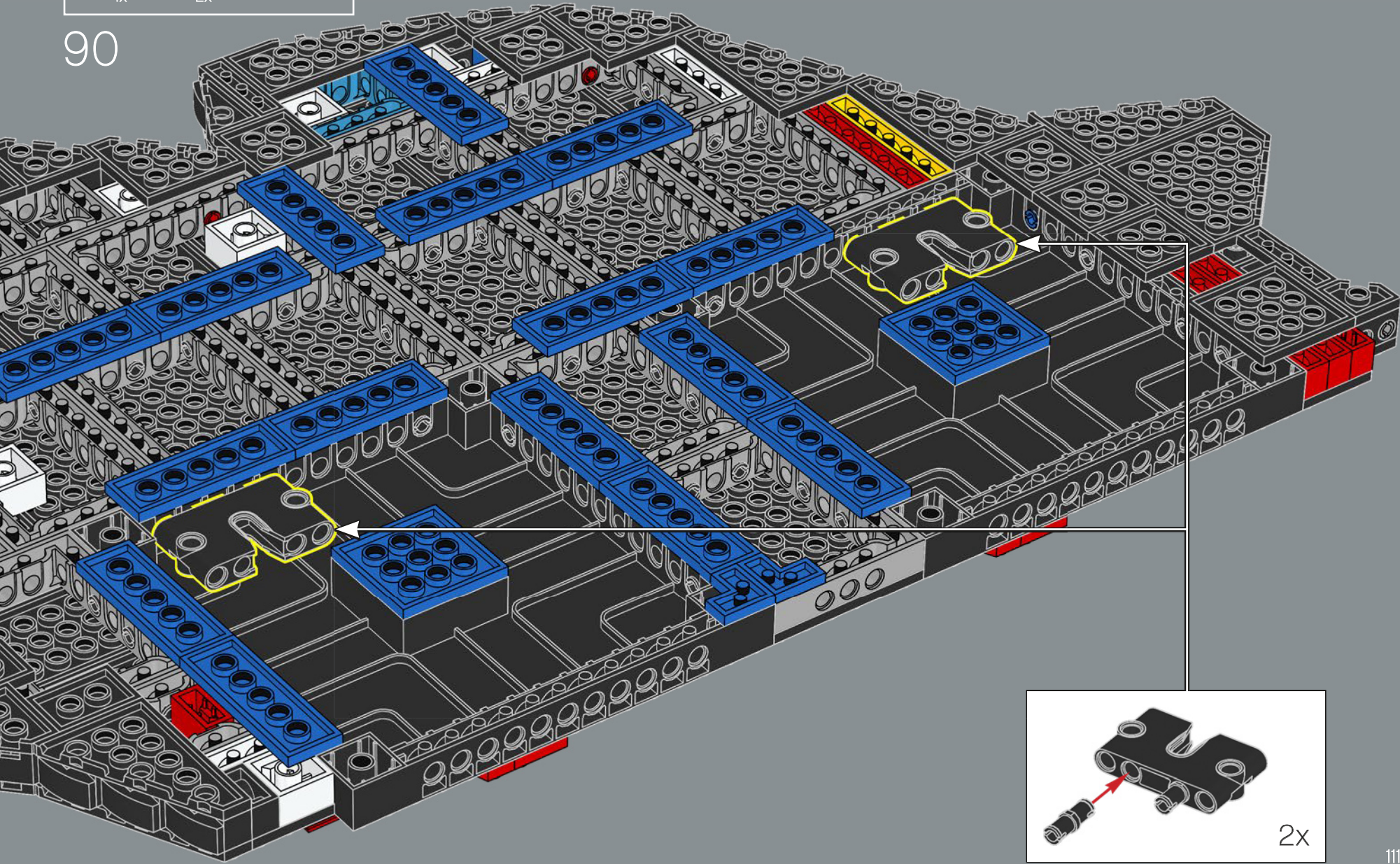

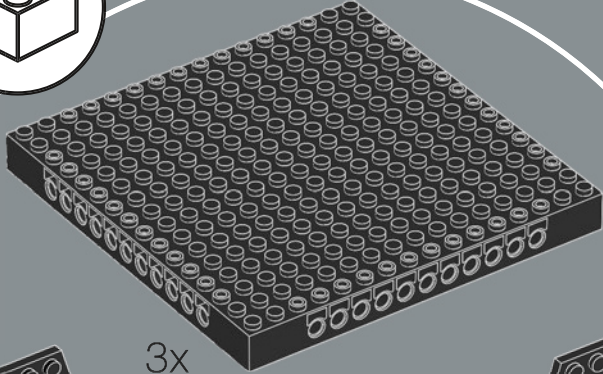
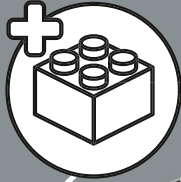

3x

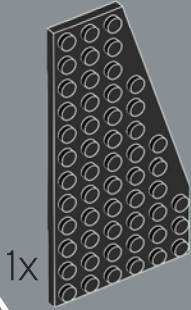

1x

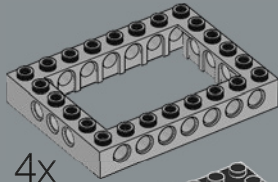

4x

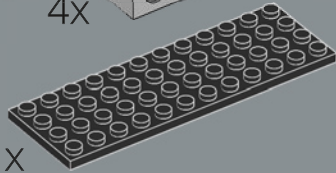

1x

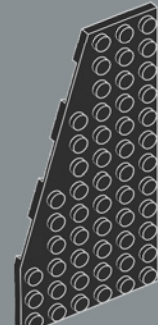

1x



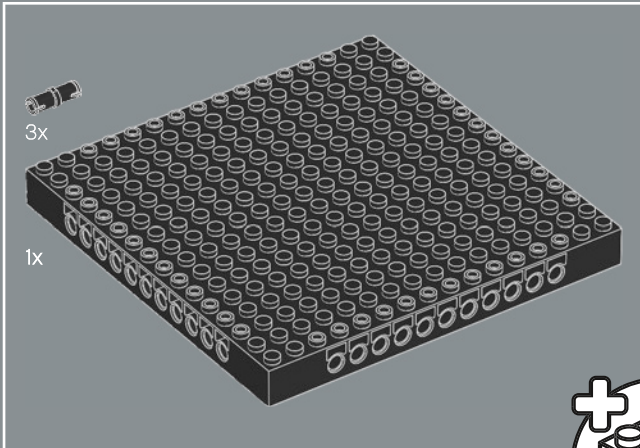
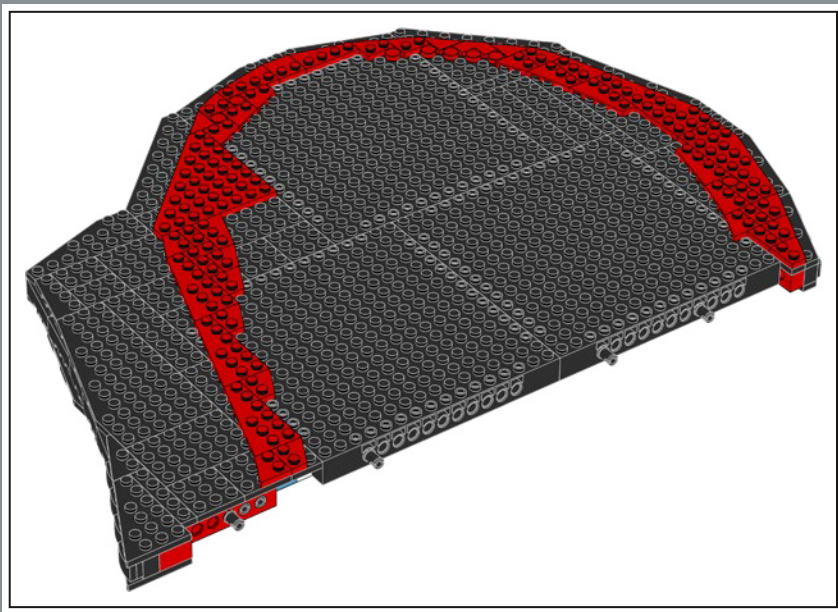

91

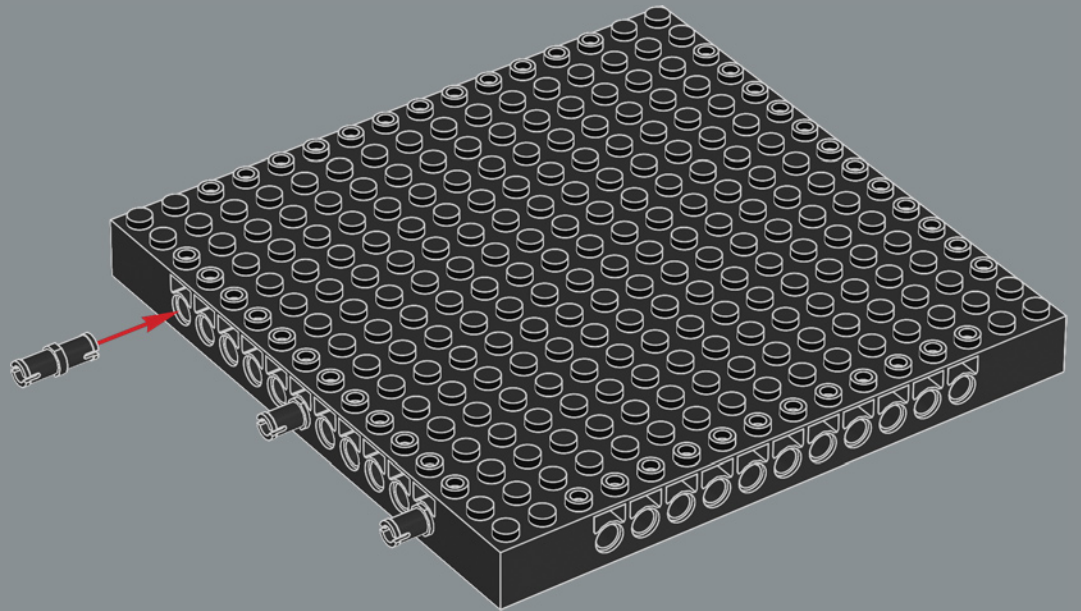
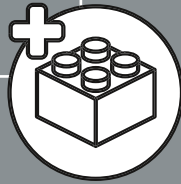

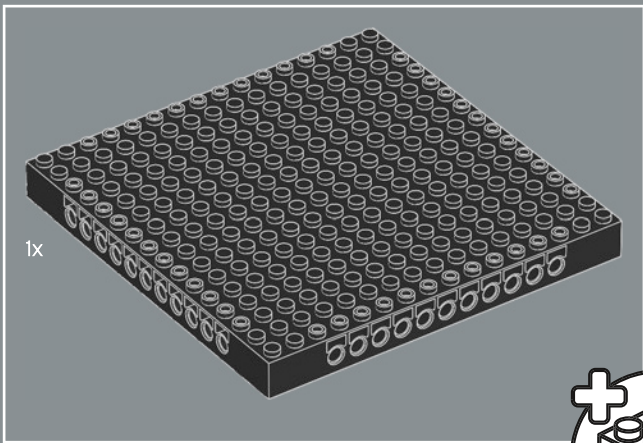

92

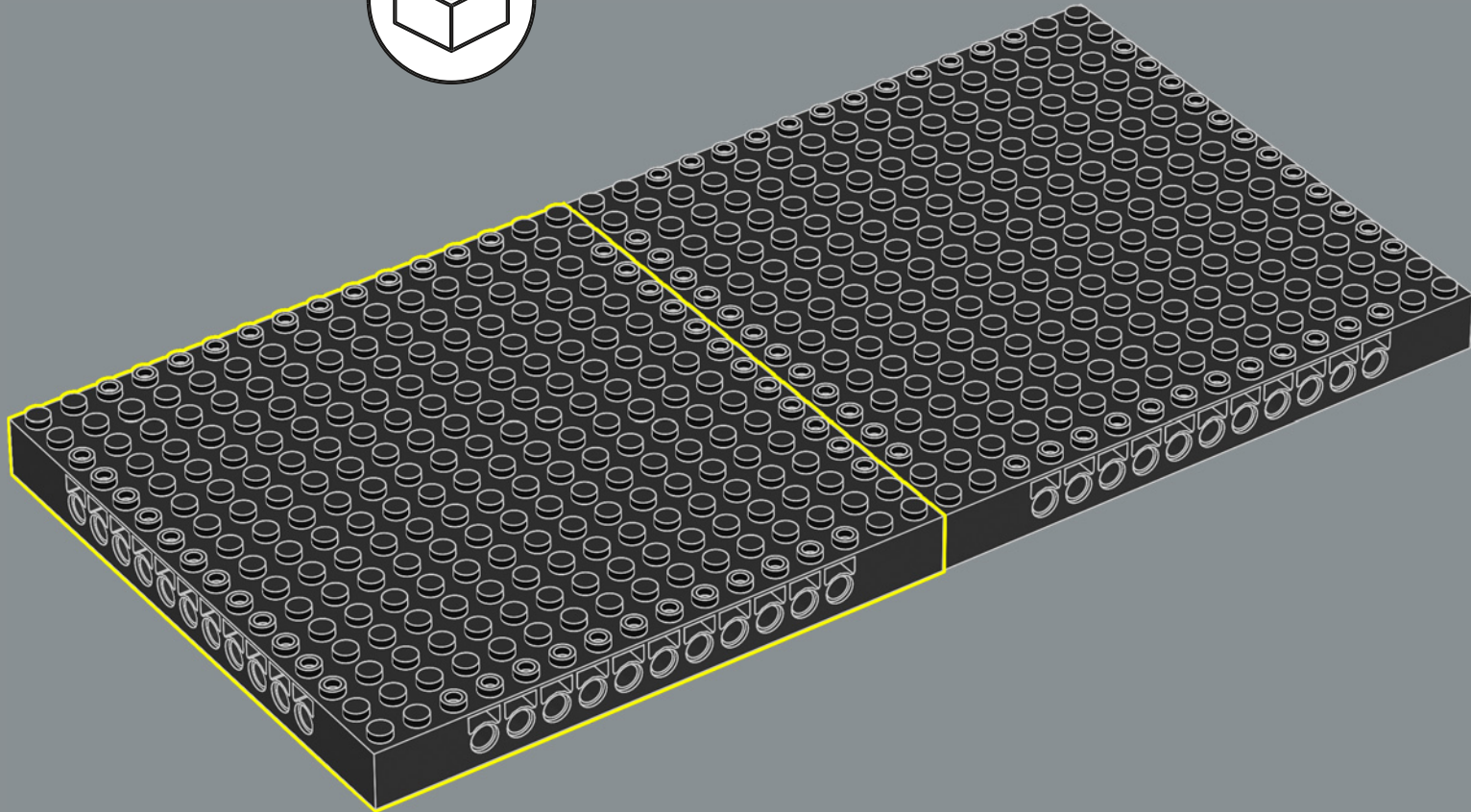
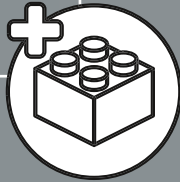

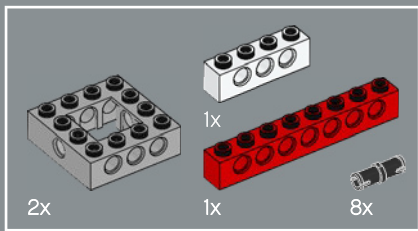

93

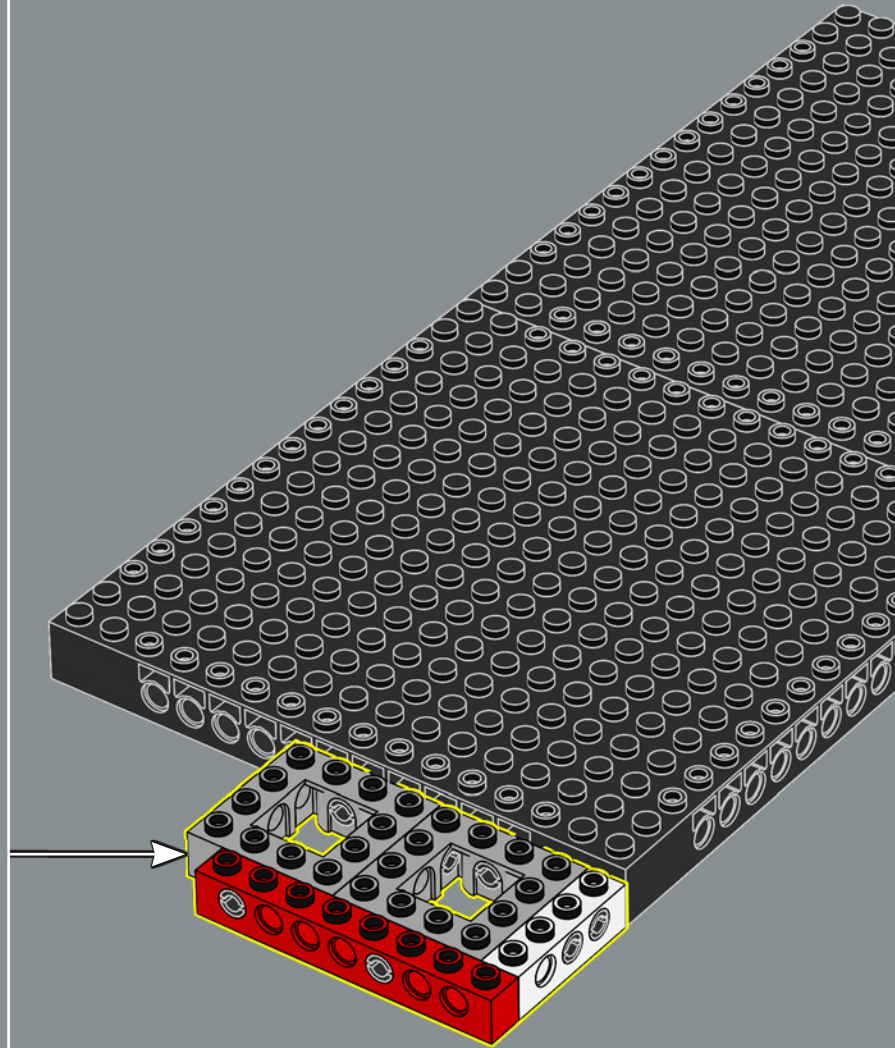
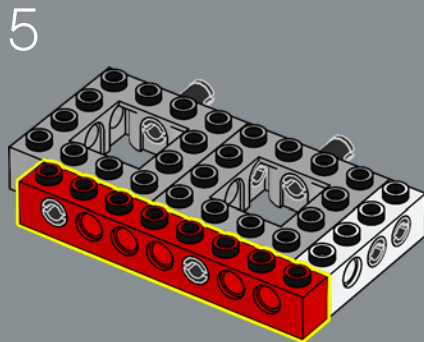
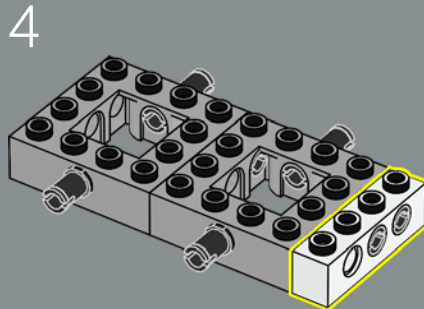
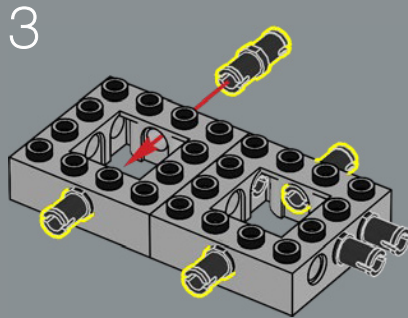
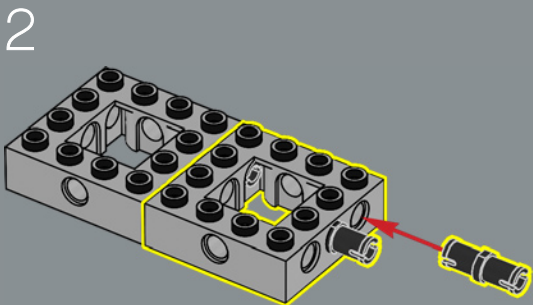
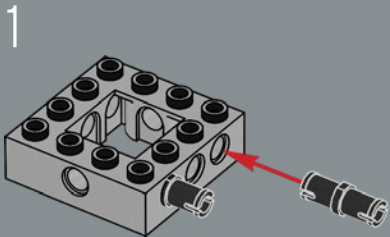

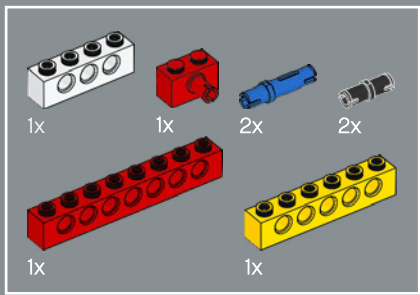

94

1

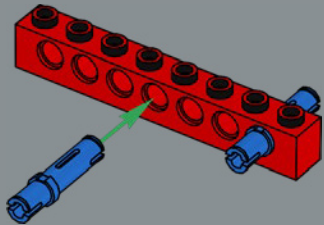

2

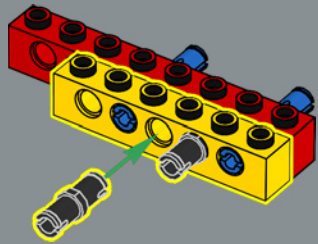

3

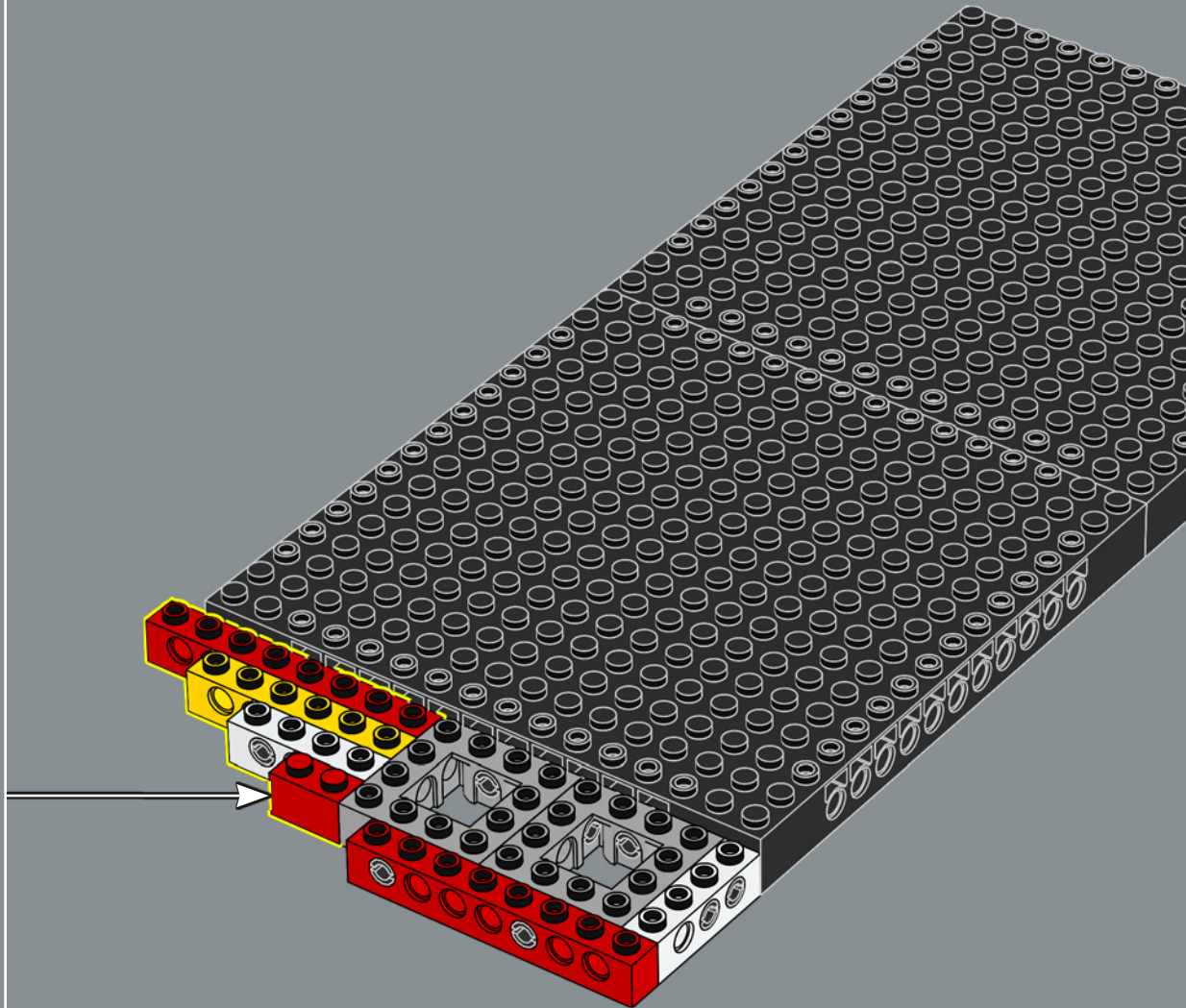
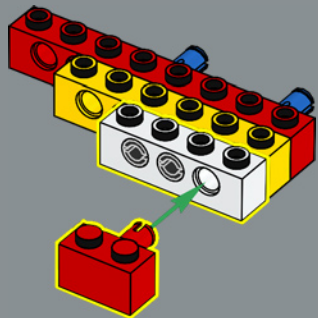

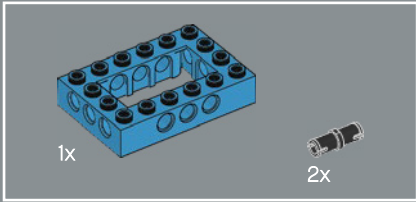
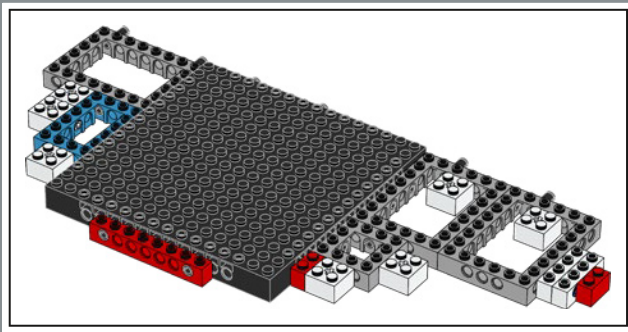

95

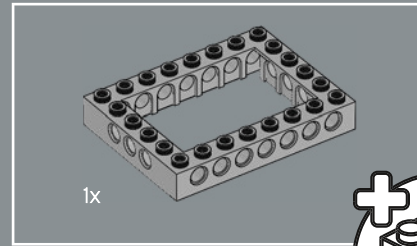
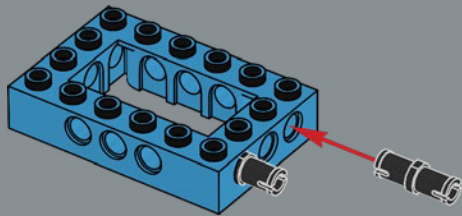

96

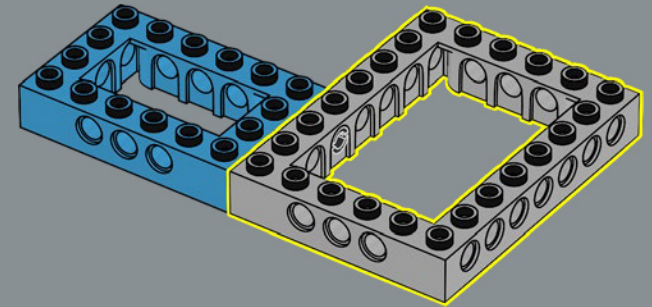
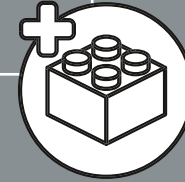

97

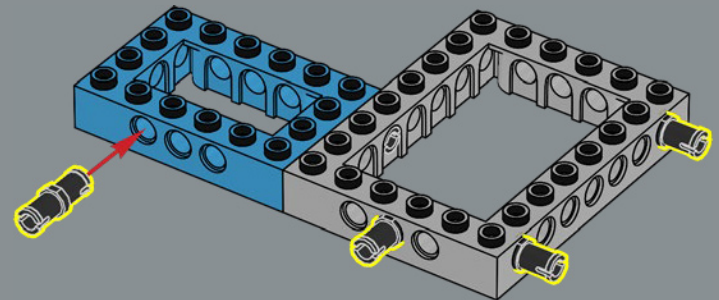

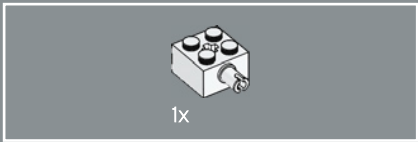

98

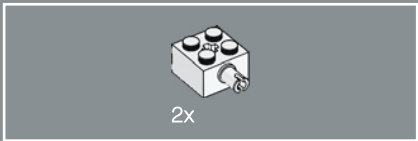
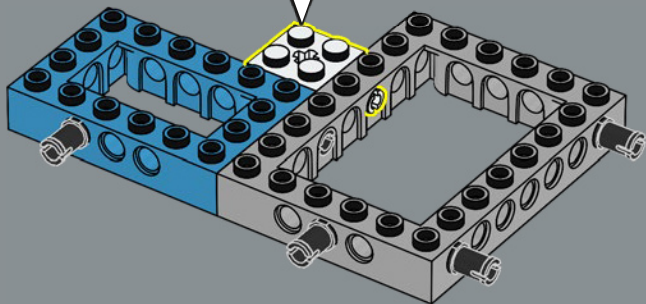
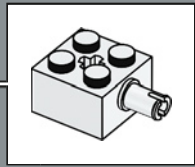

99

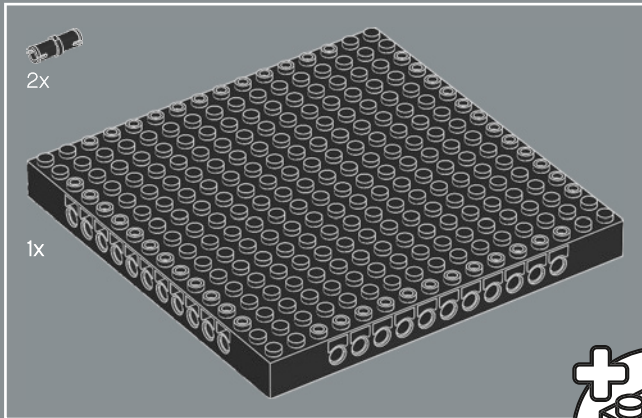
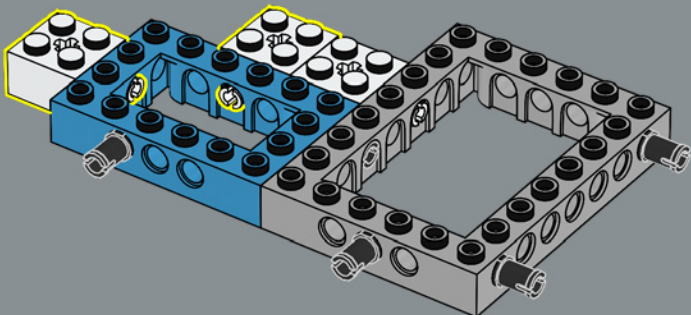

100

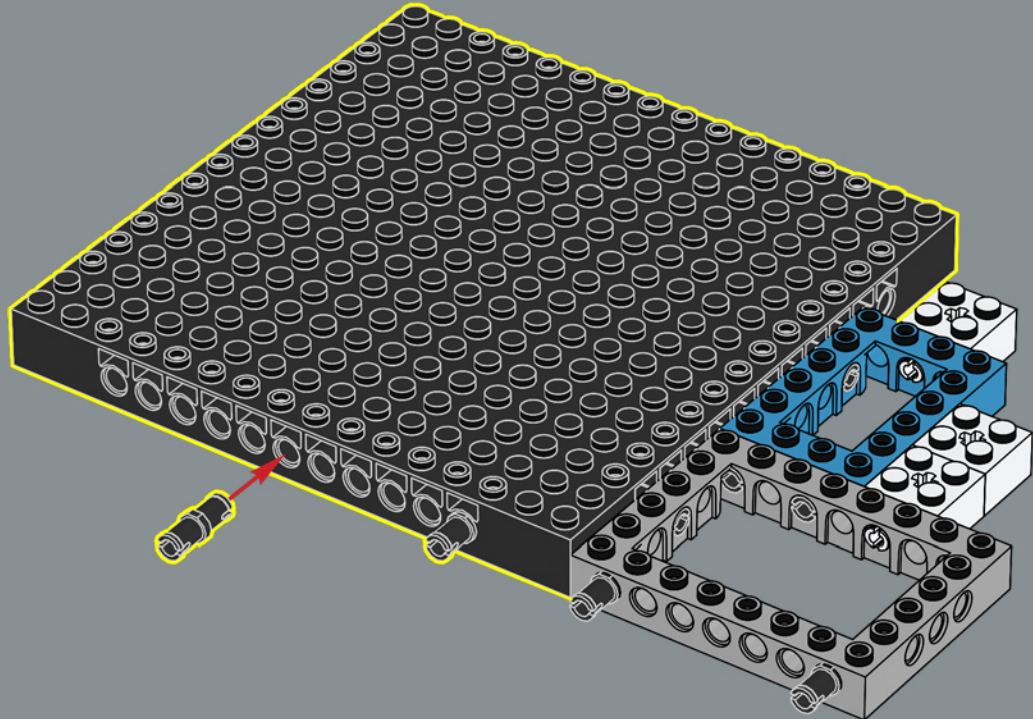
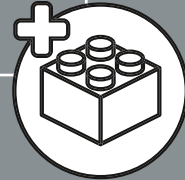

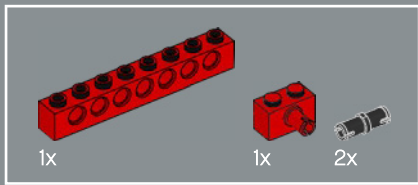

101

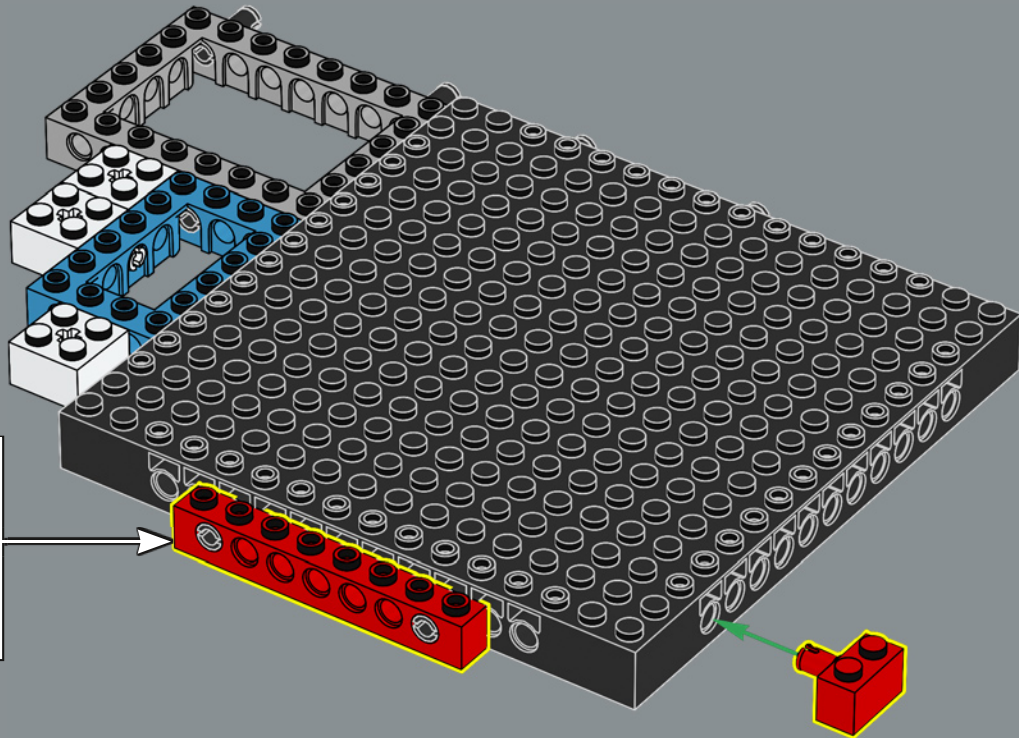
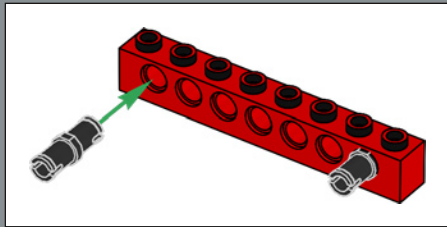

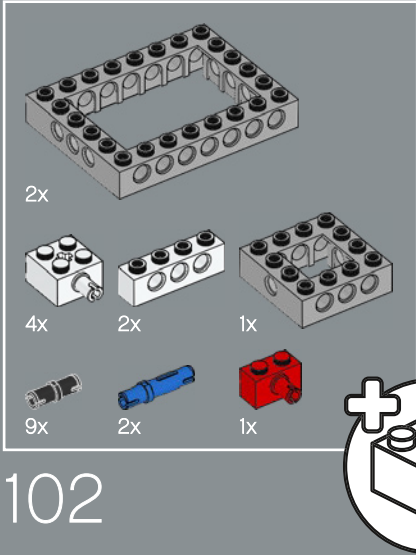
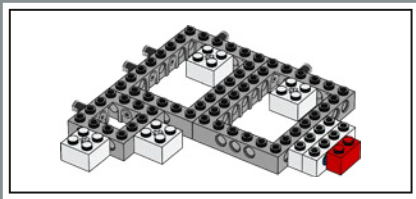

102

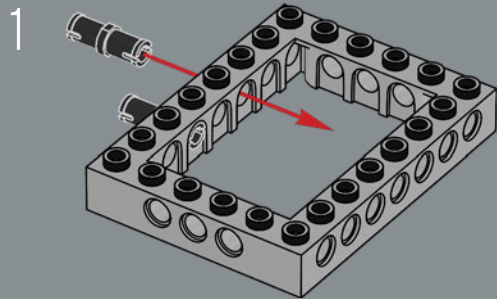

2

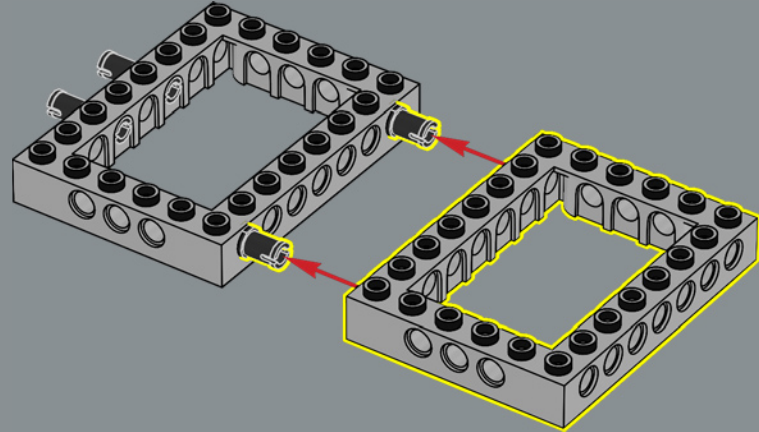

3

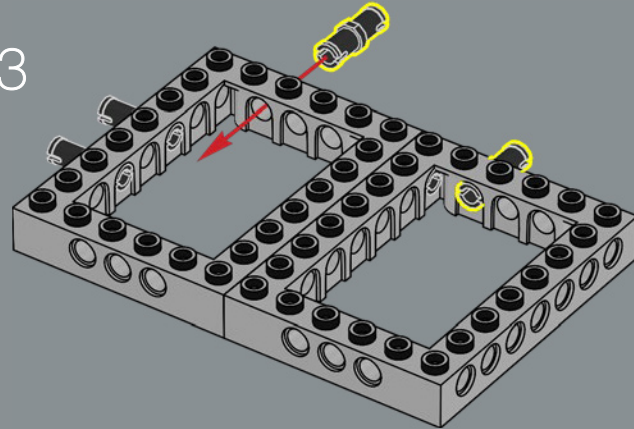

4

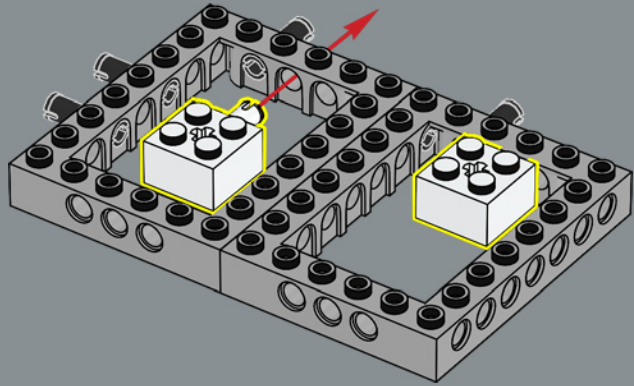

5

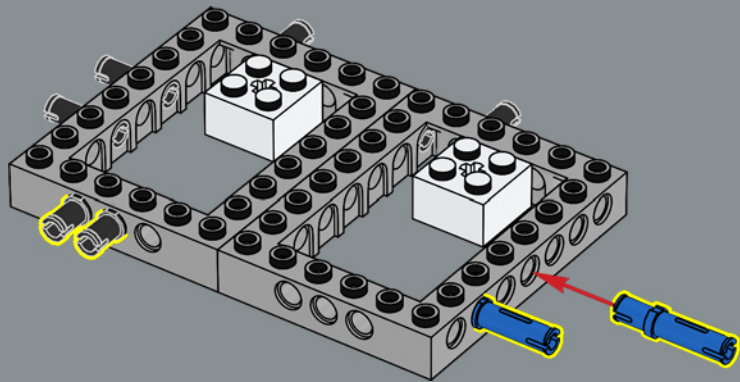

6

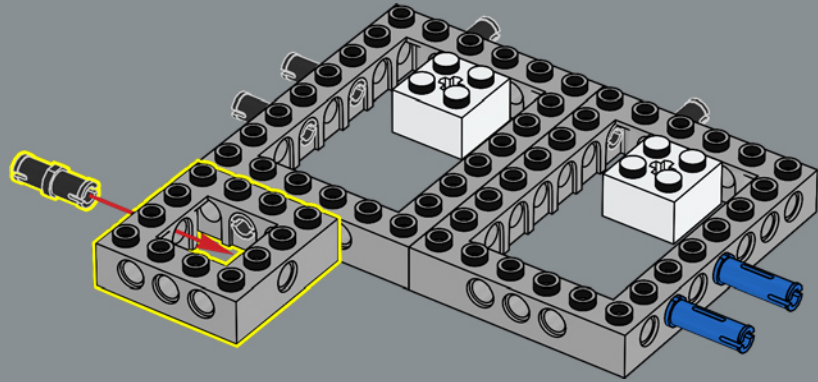

7

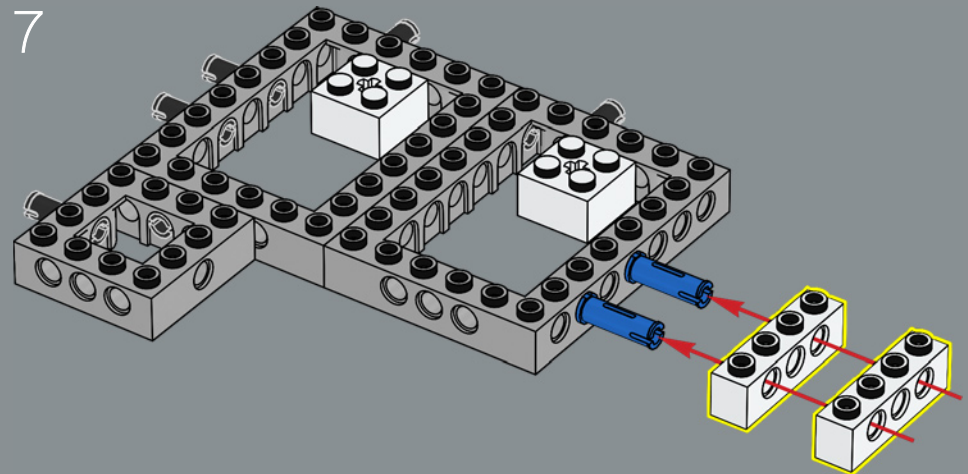

8

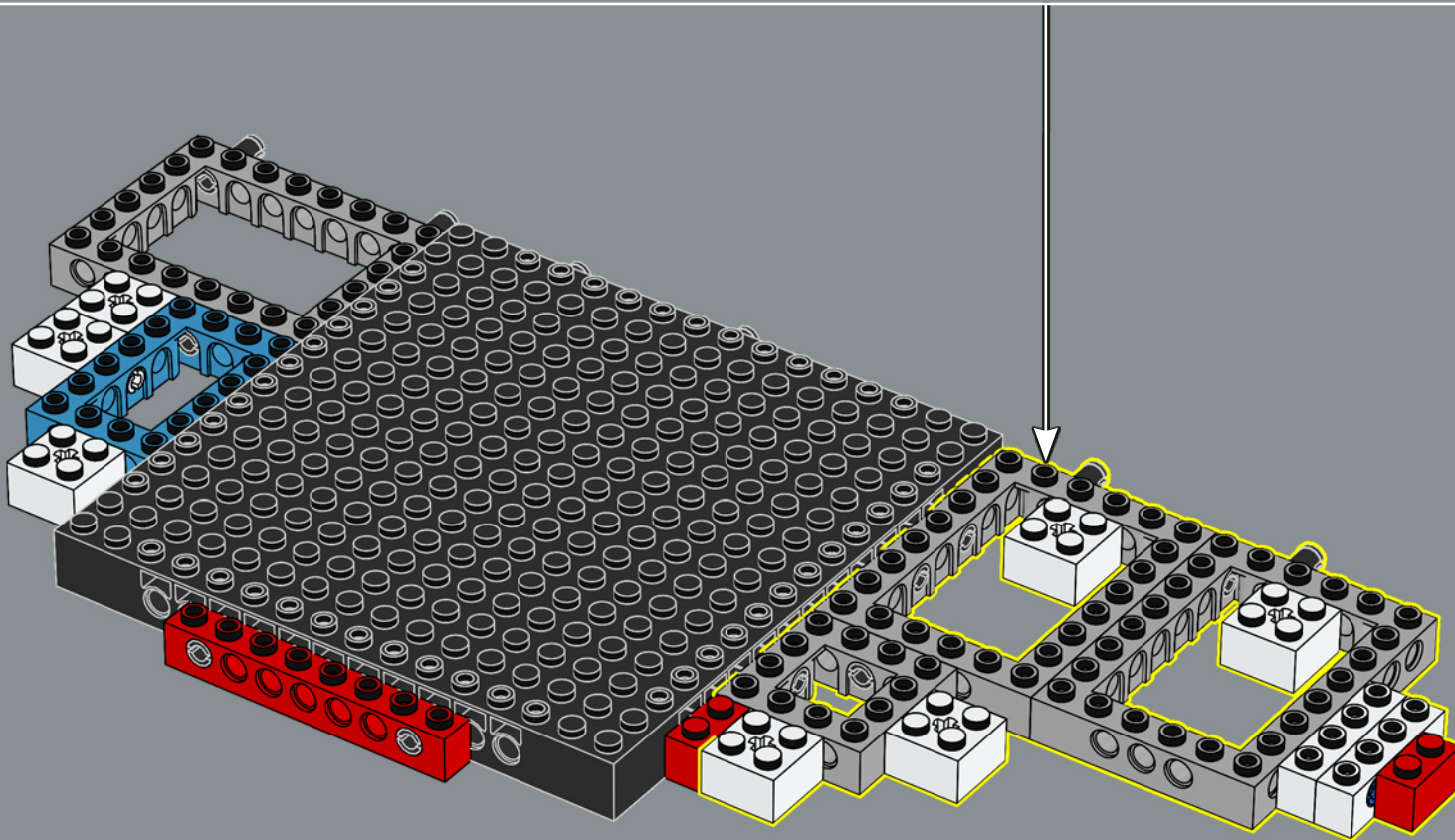
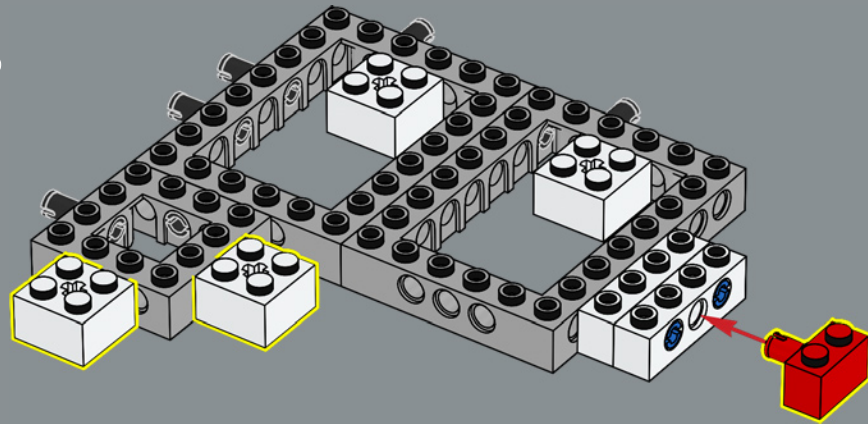

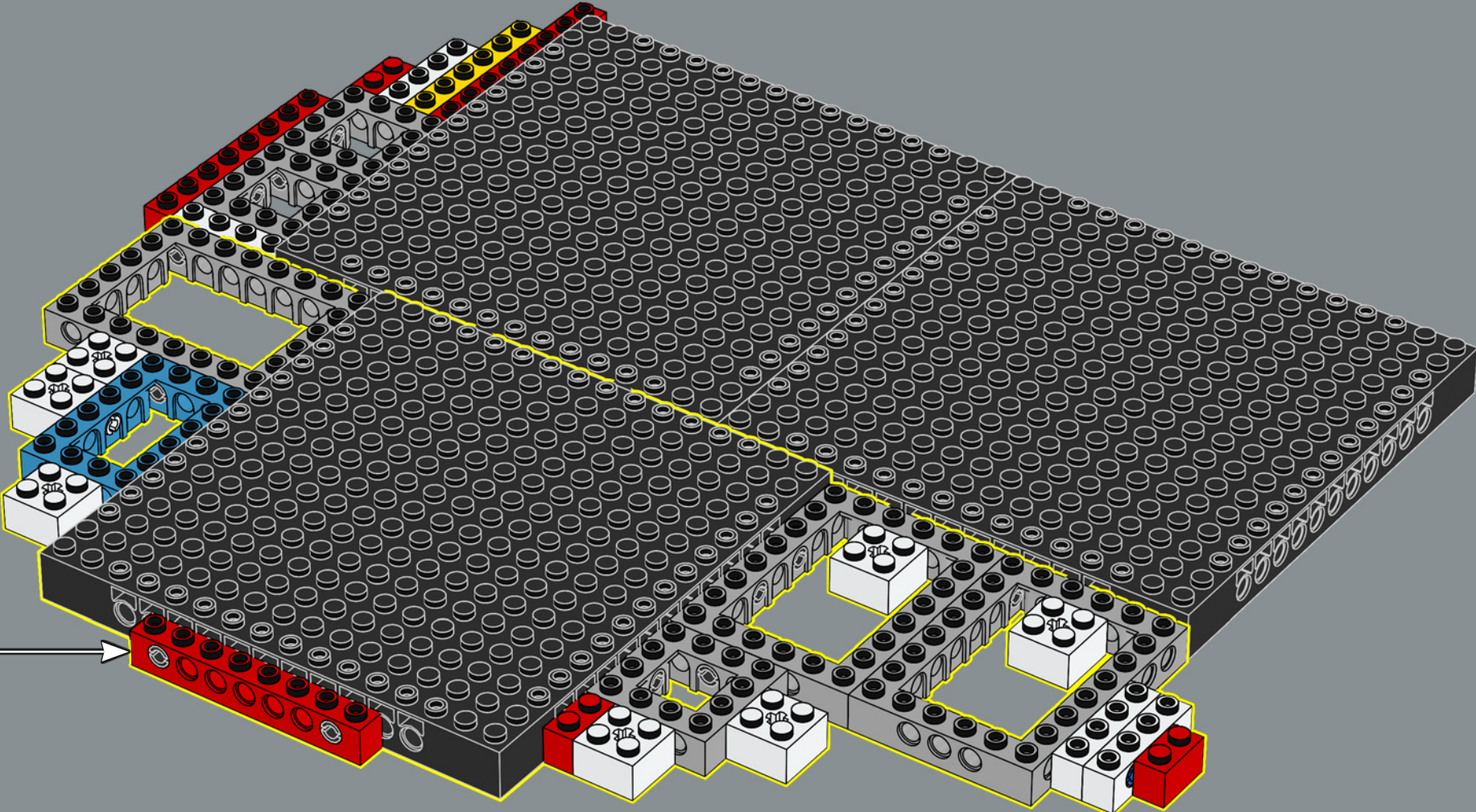

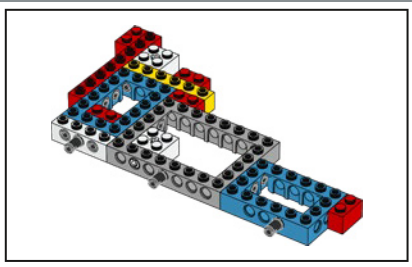

1

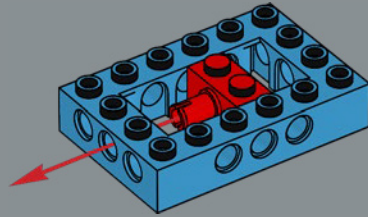

2

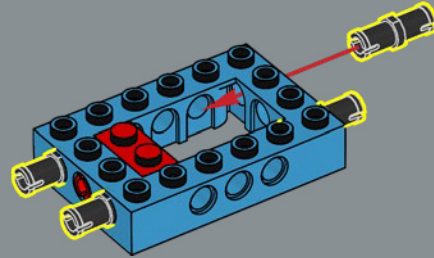

3

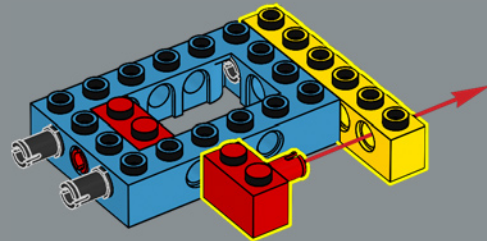

1

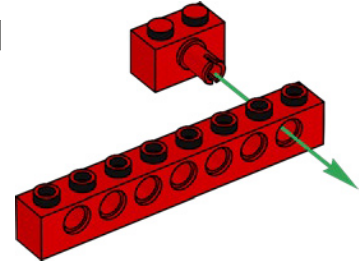

2

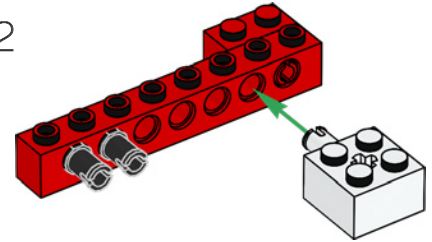

4

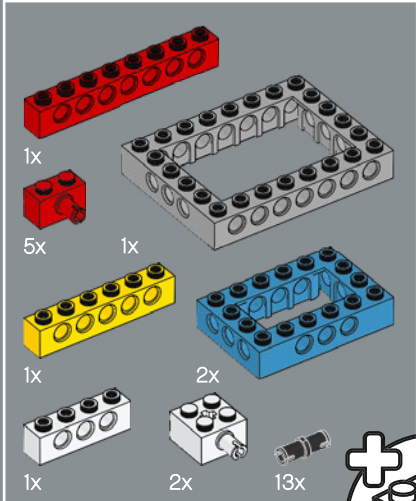
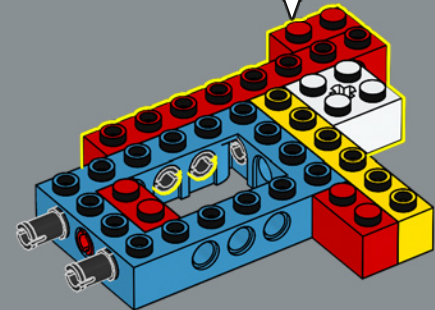

104

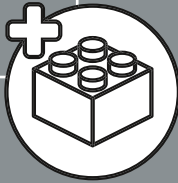

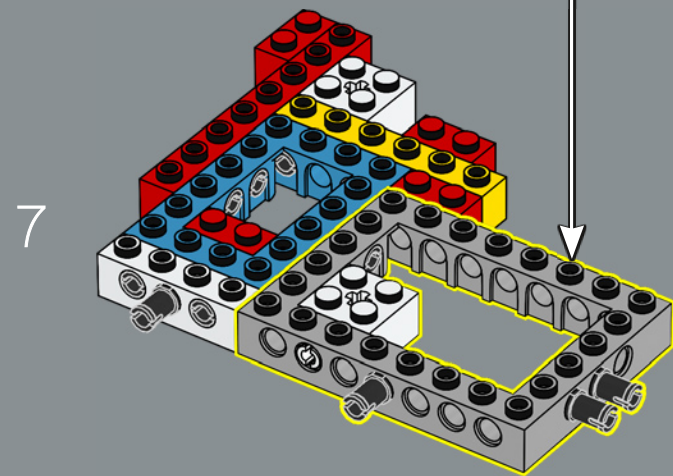
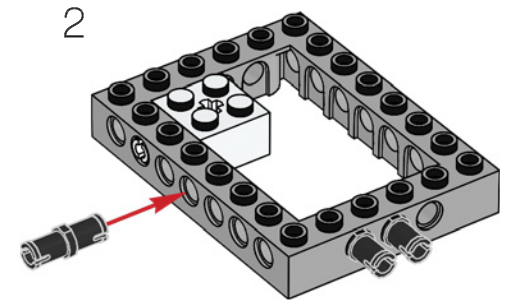
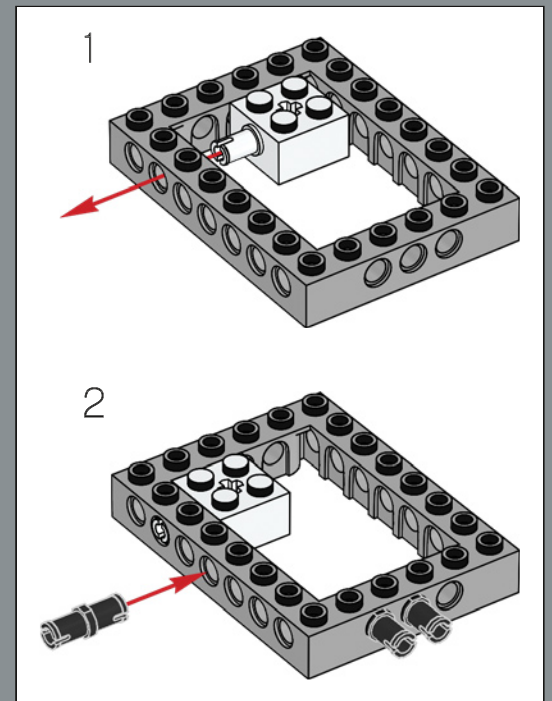
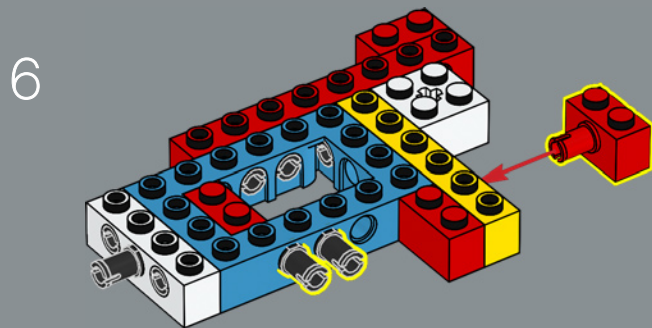
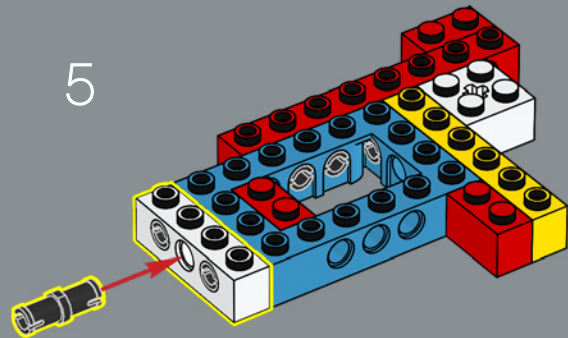

8

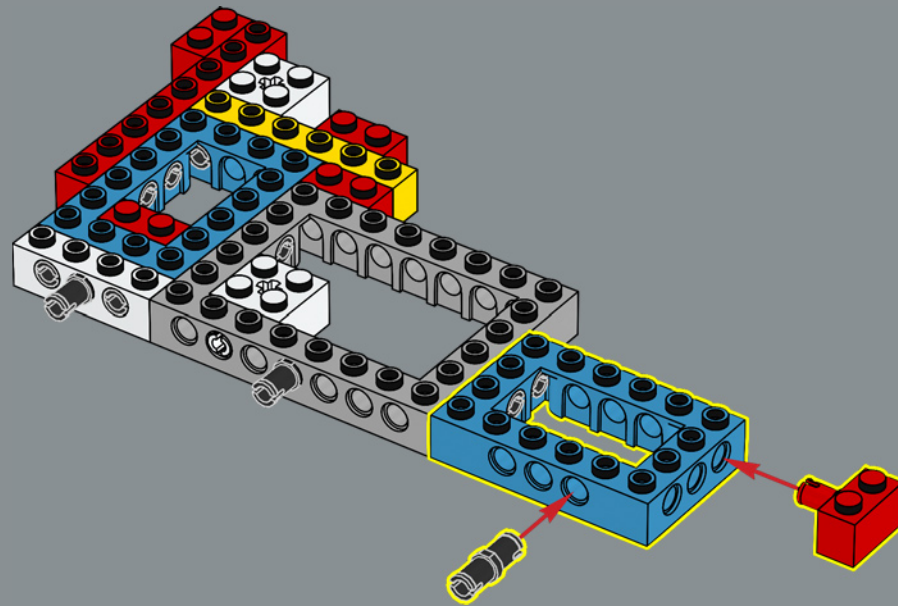

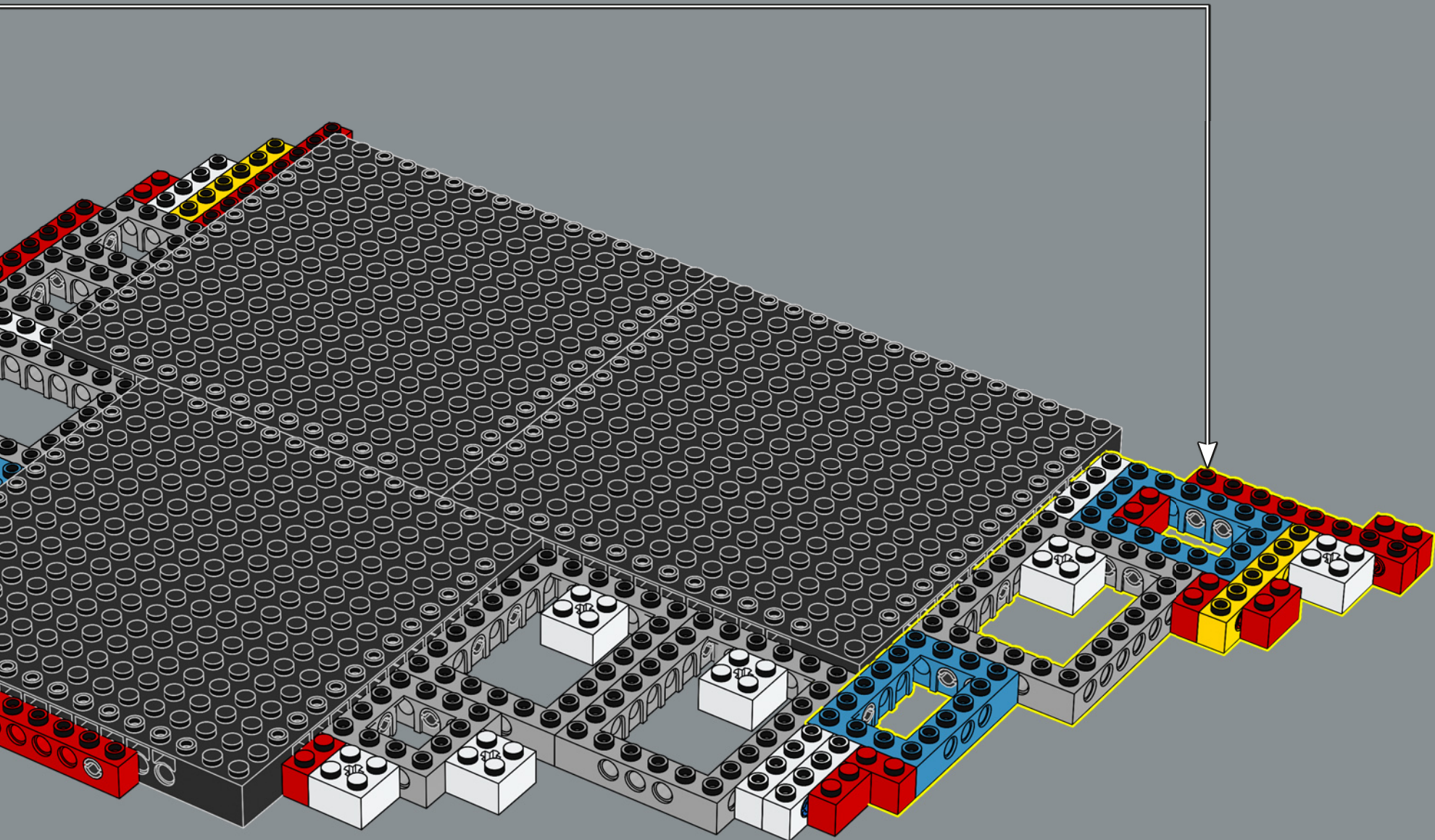

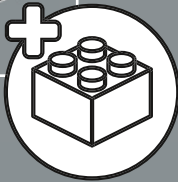
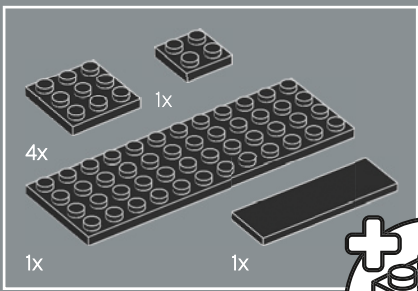

105

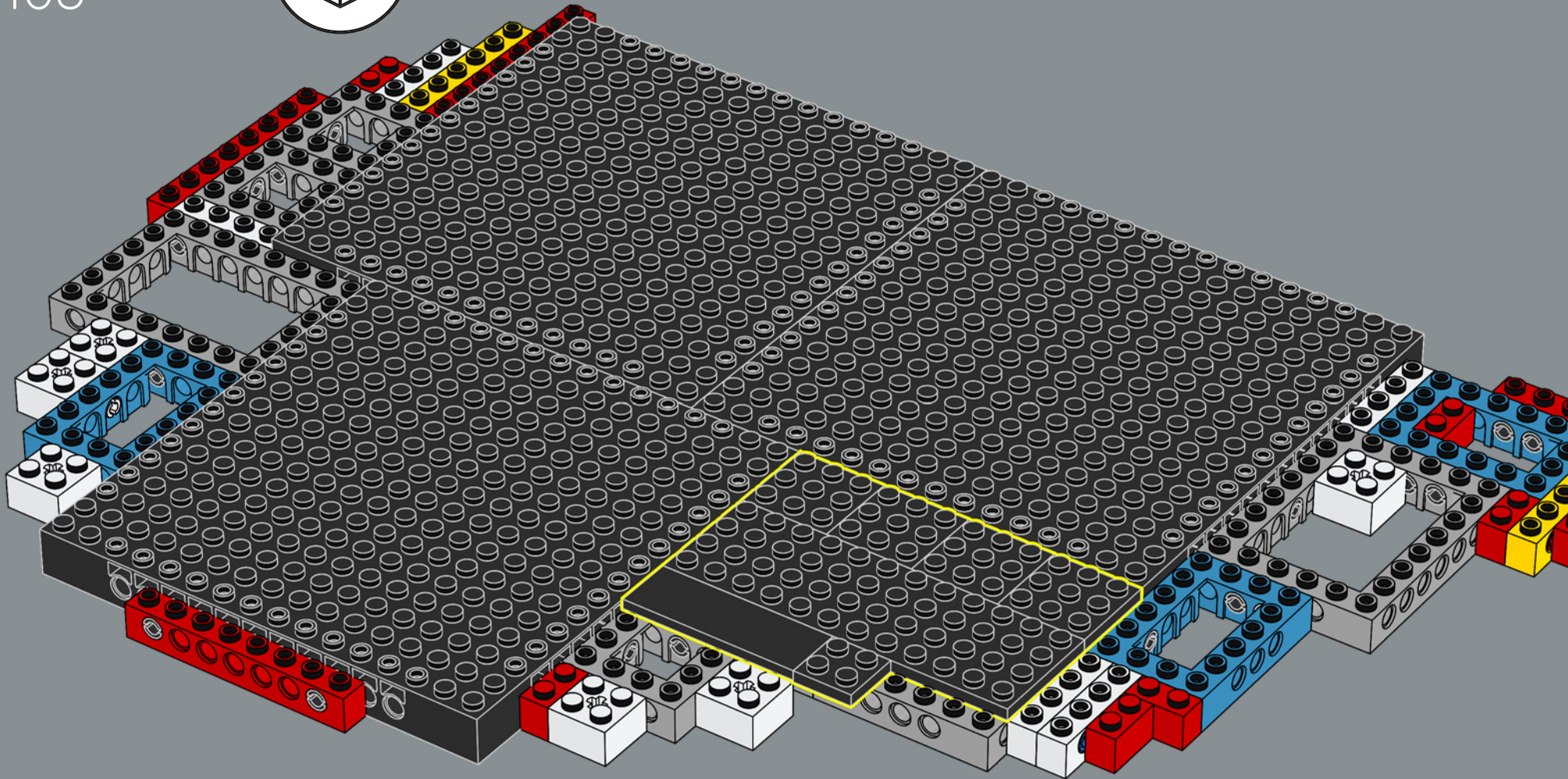

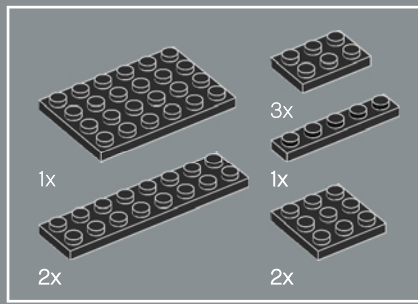

106

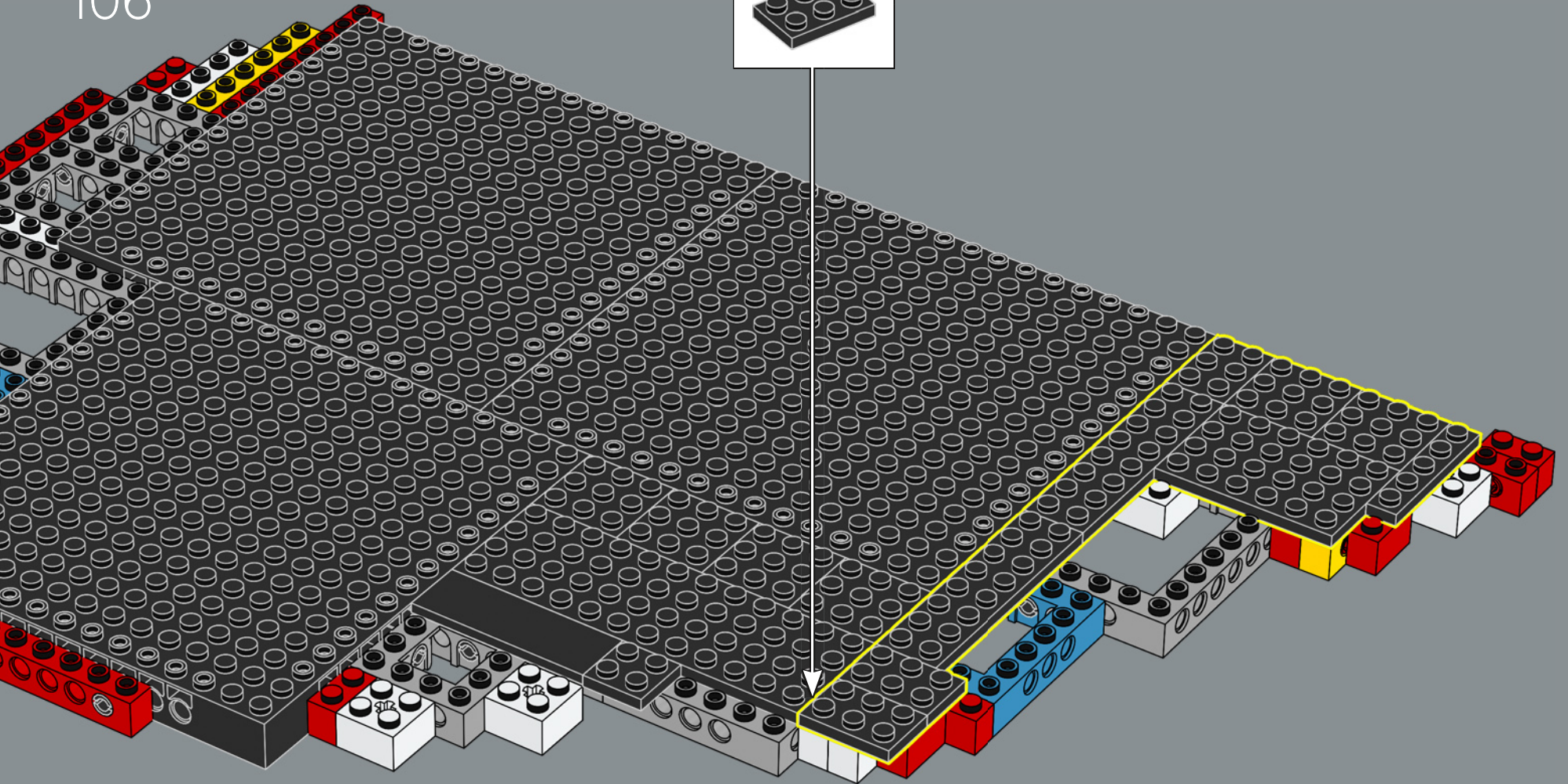
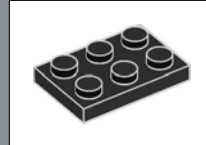

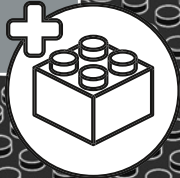
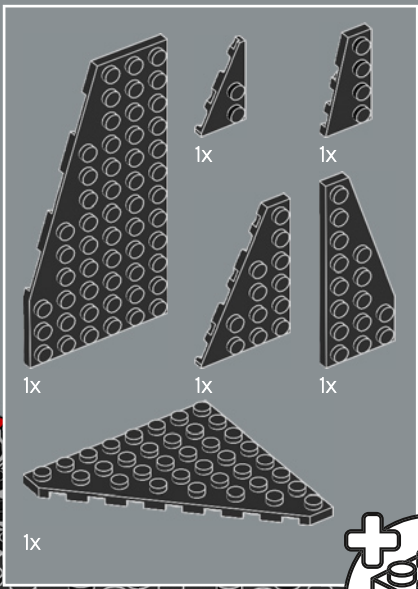

107

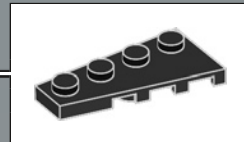
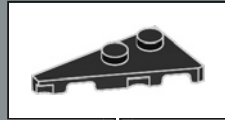

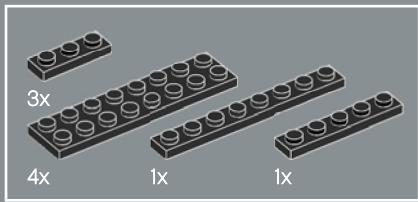

108

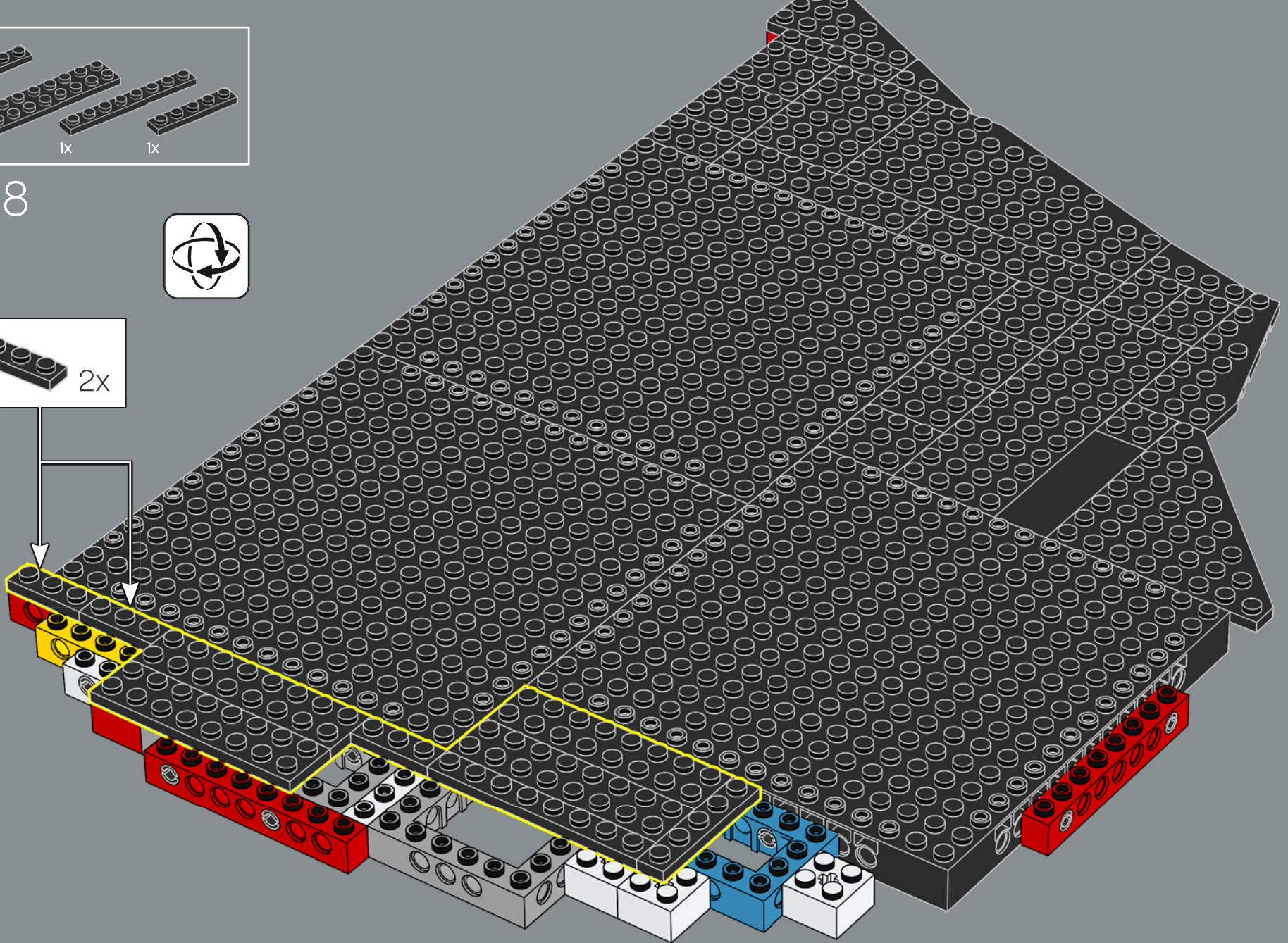
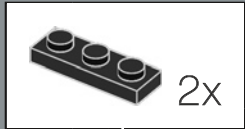

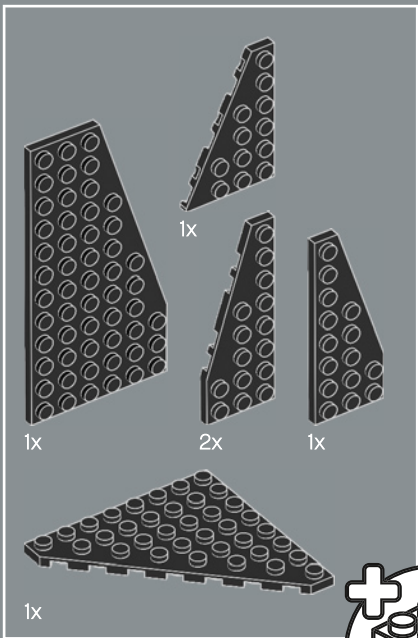

109

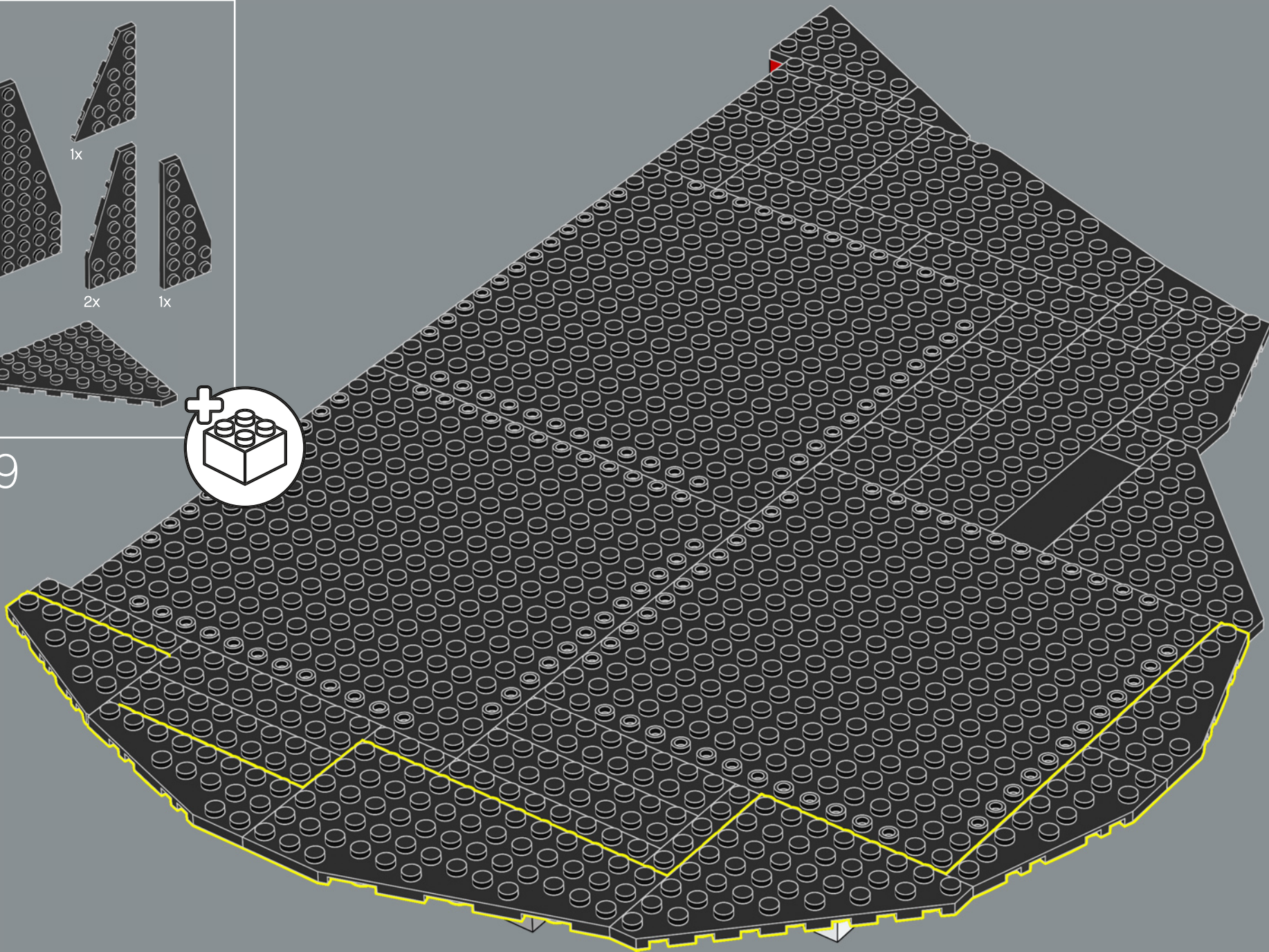

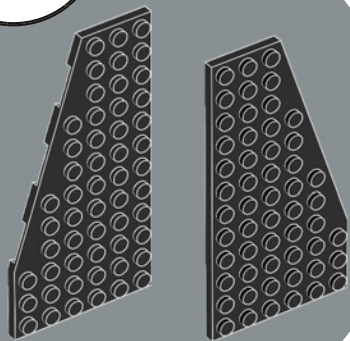
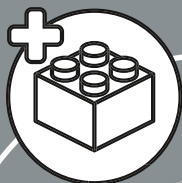

1x

1x



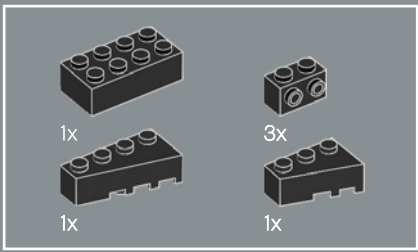

110

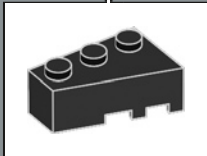
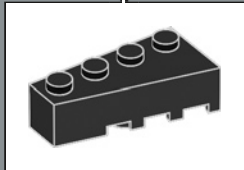
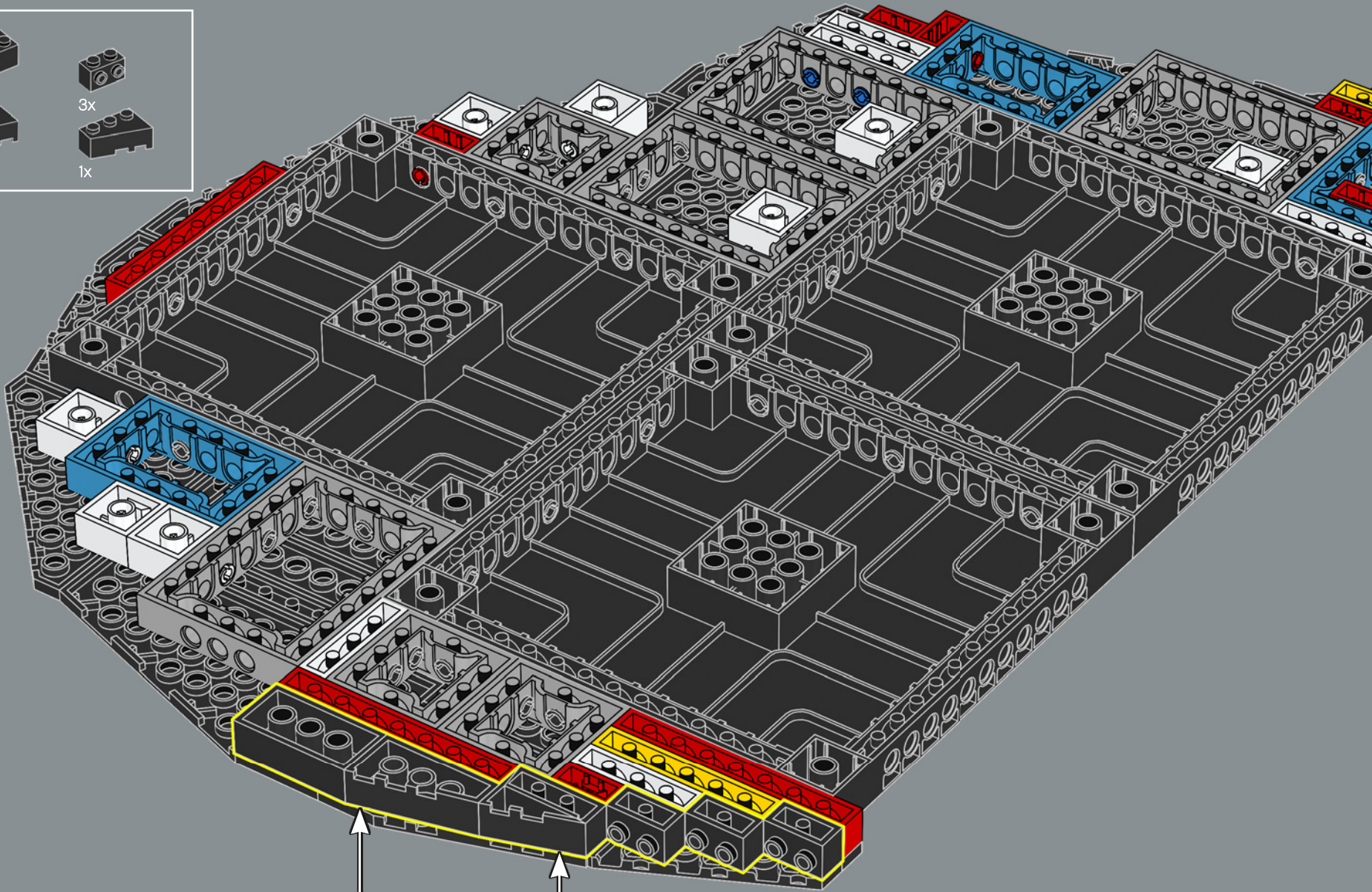

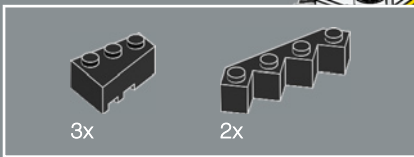

111

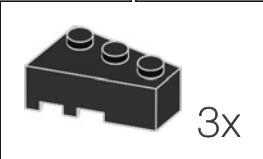
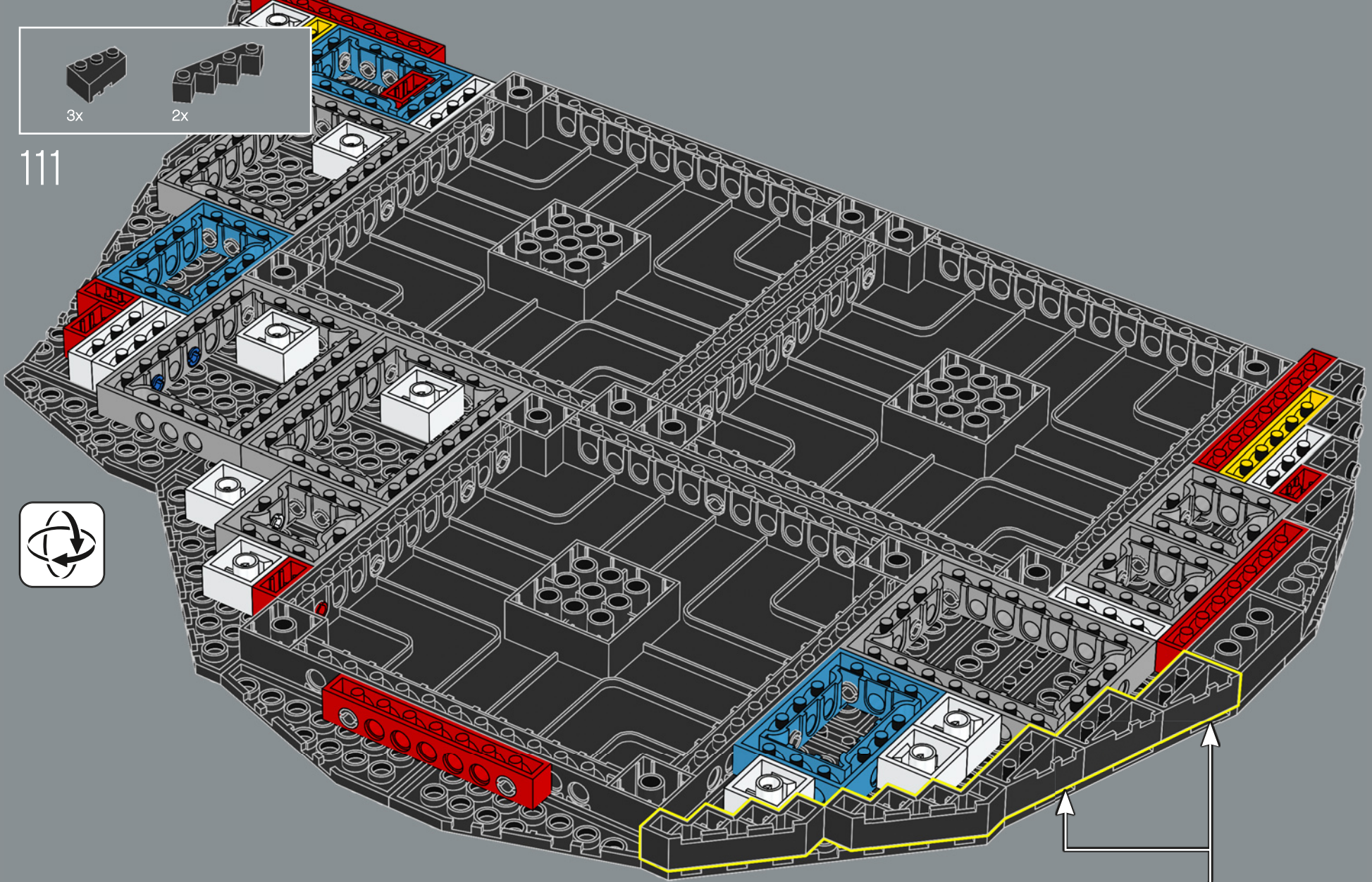

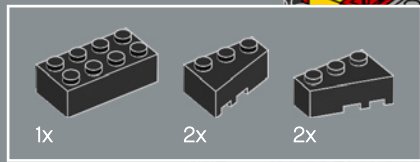

112

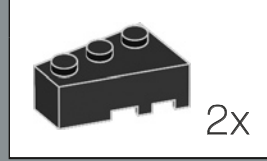
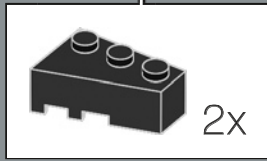
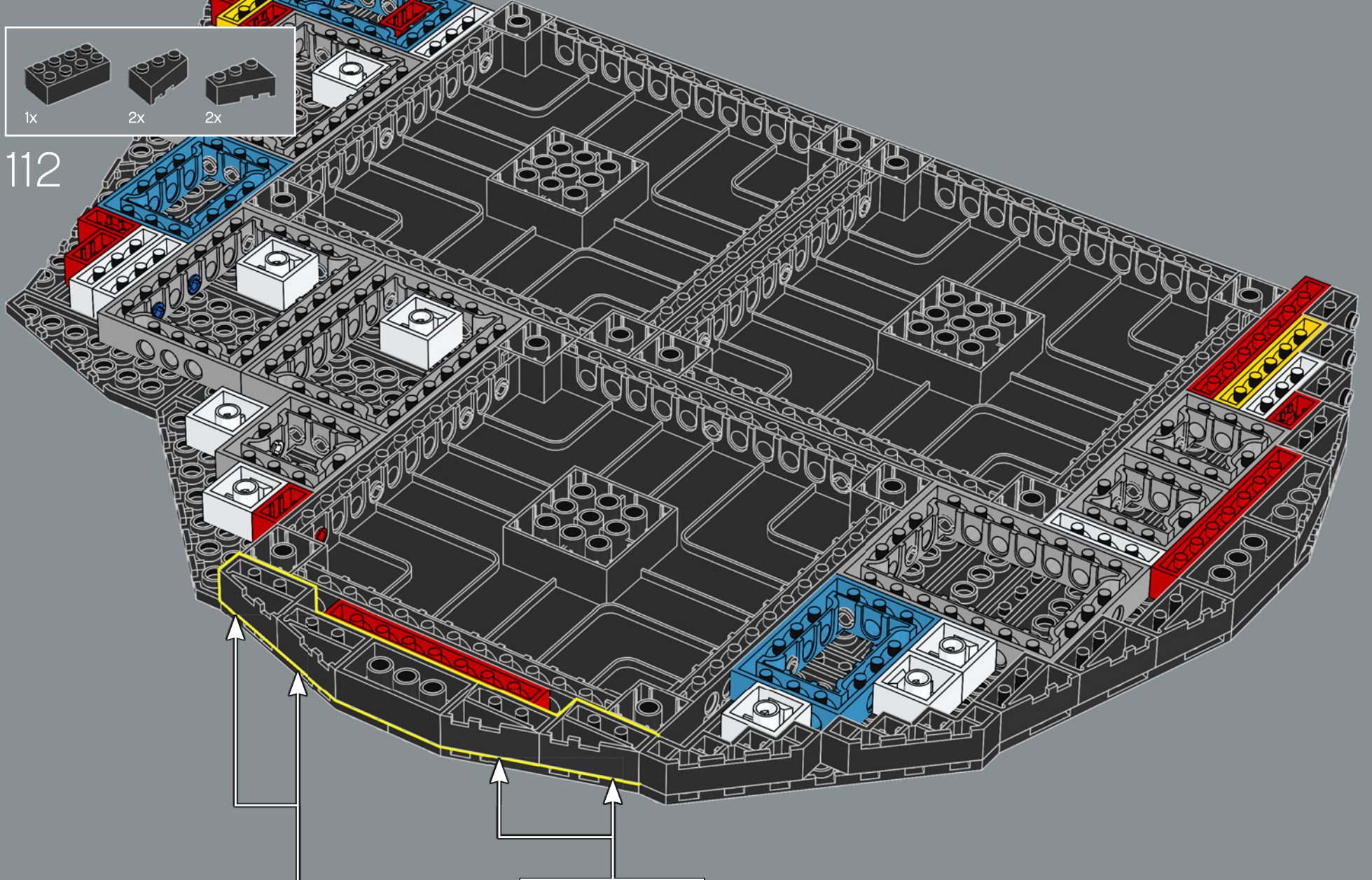

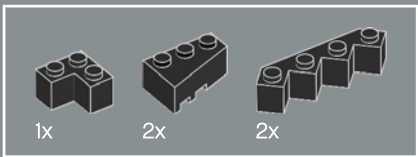

113

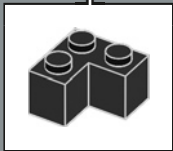
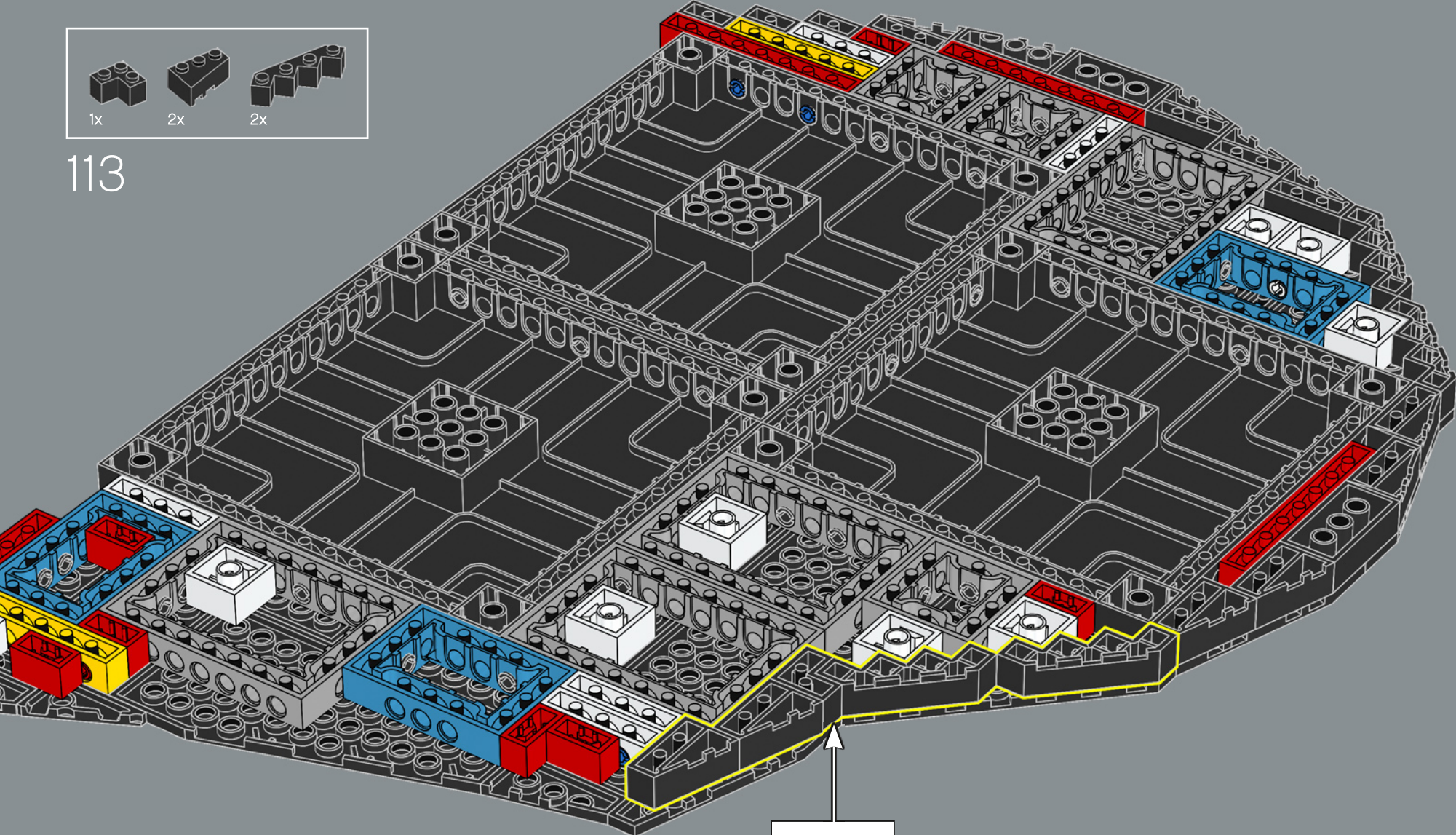

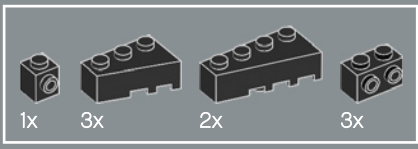

114

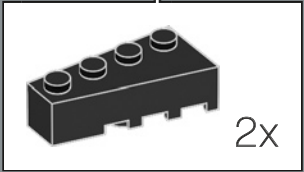
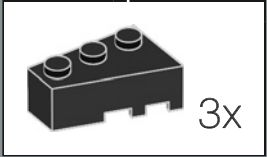
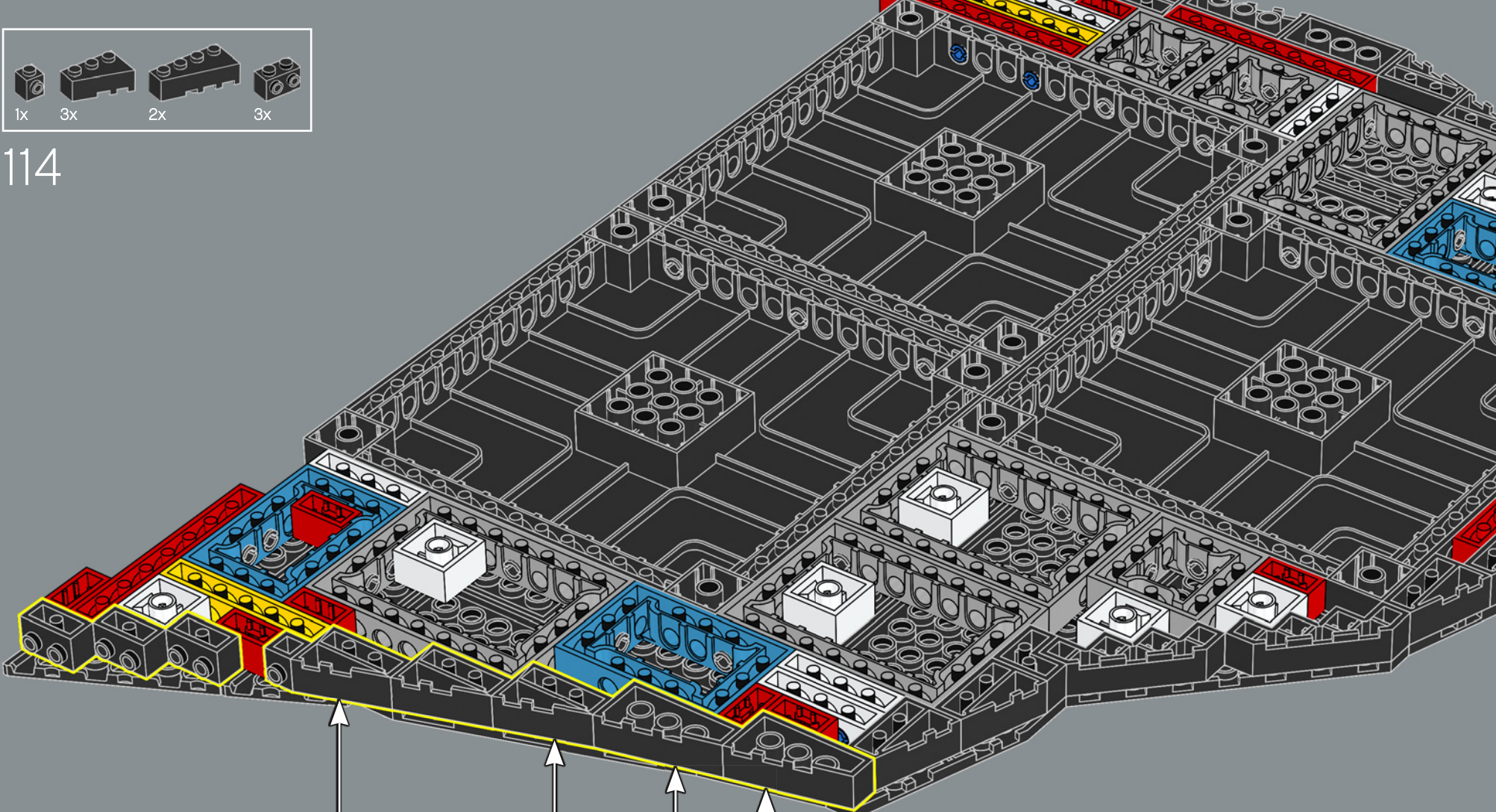



115

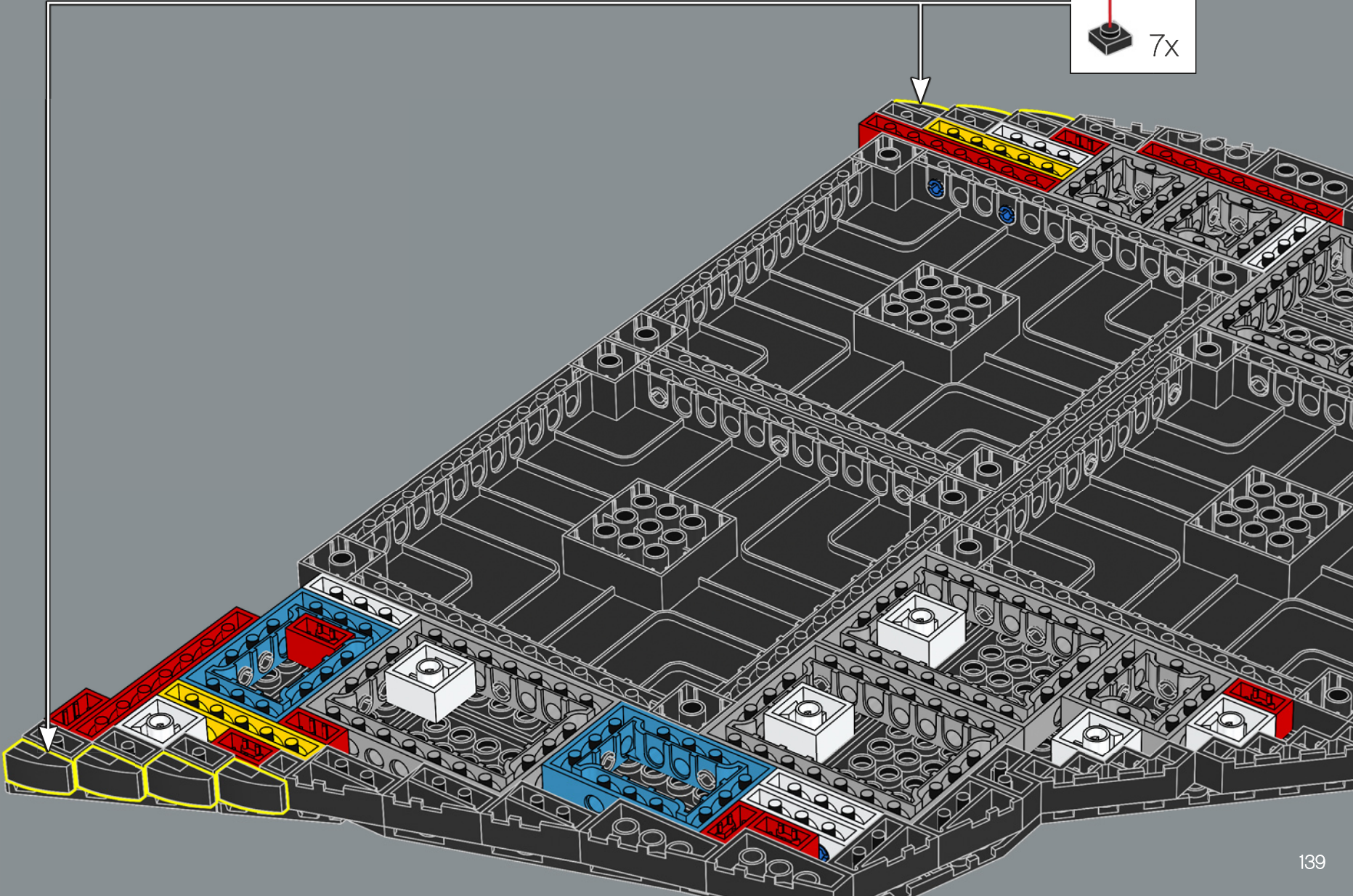
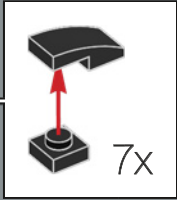

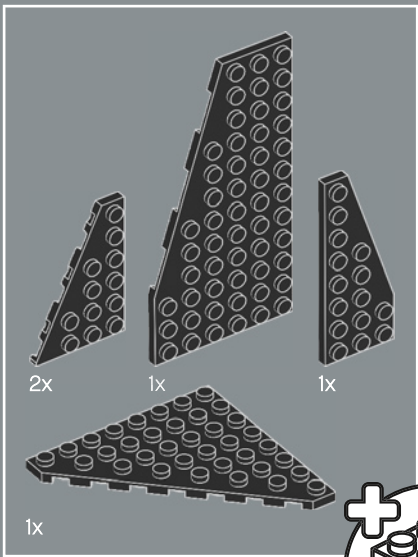

116

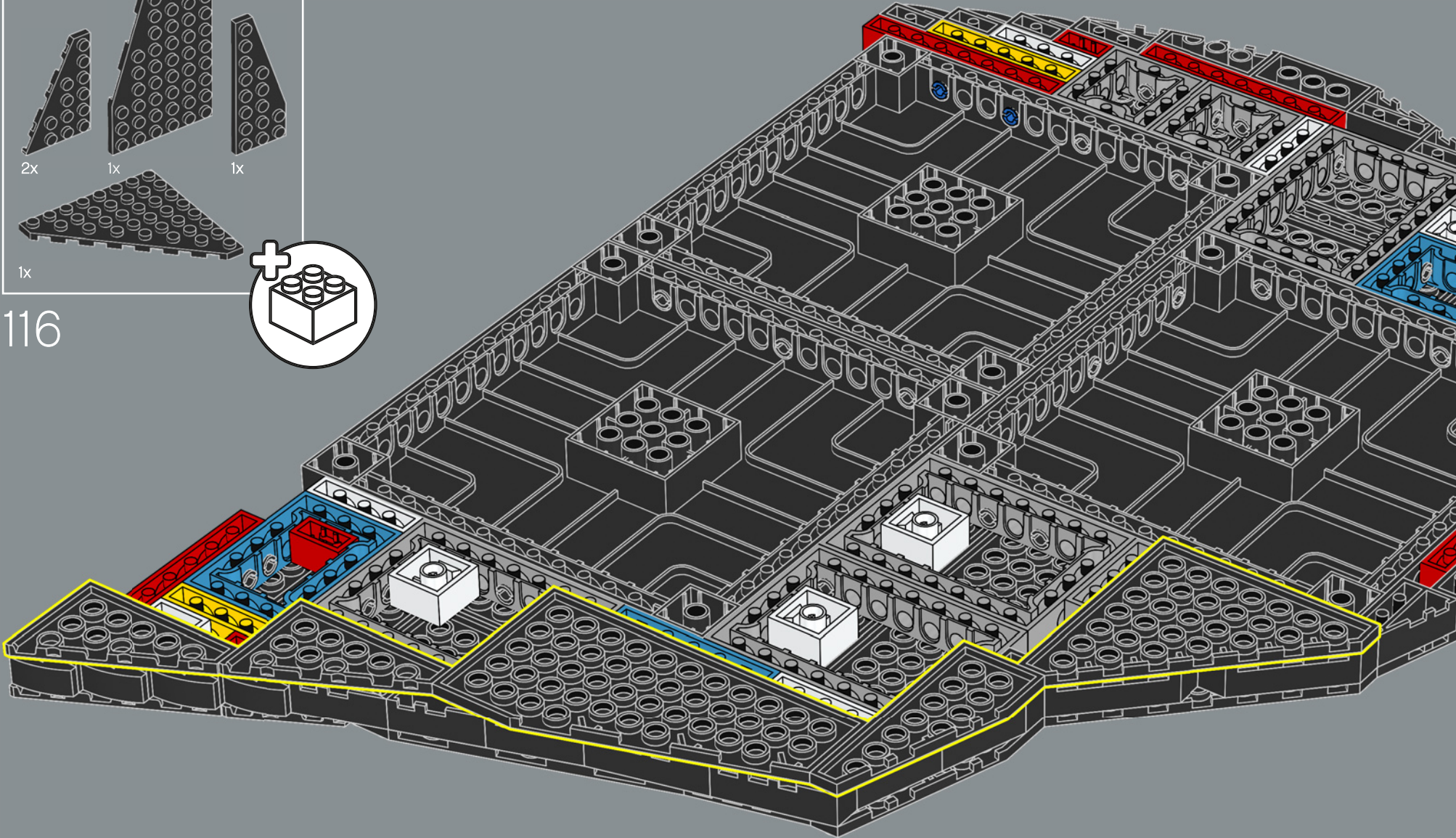

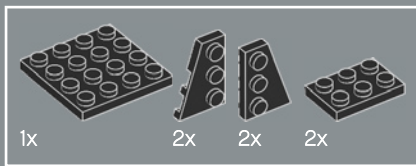

117

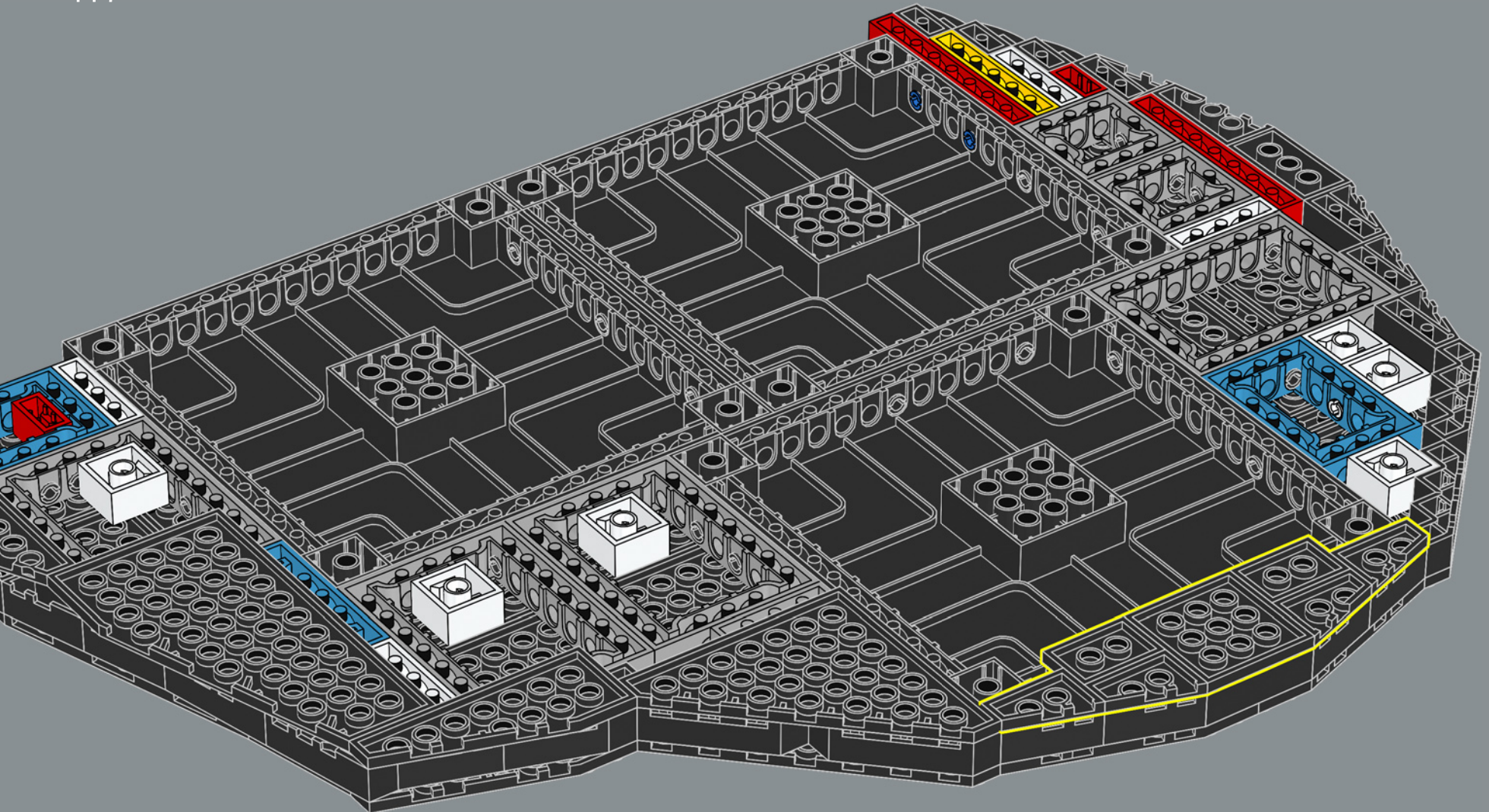

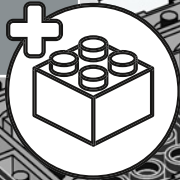
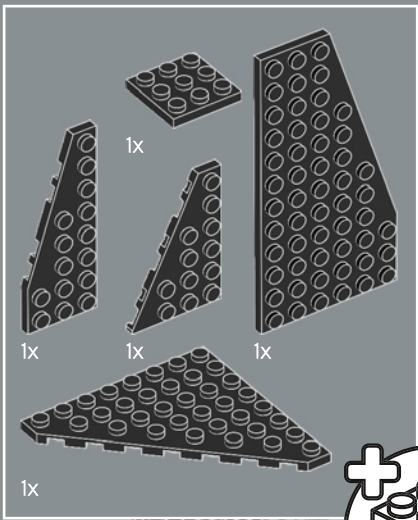

118

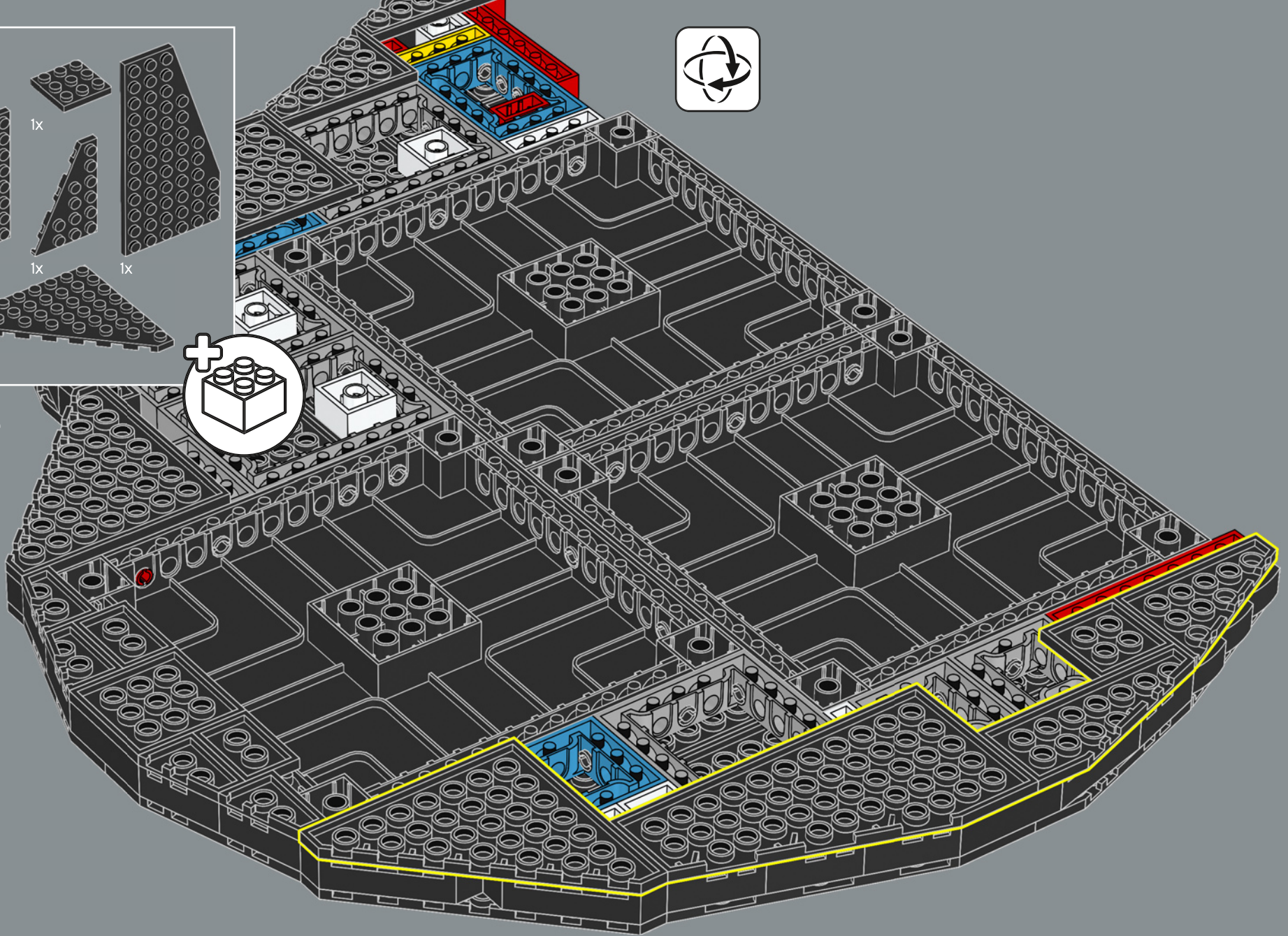

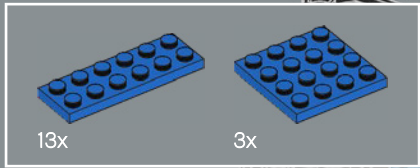

119

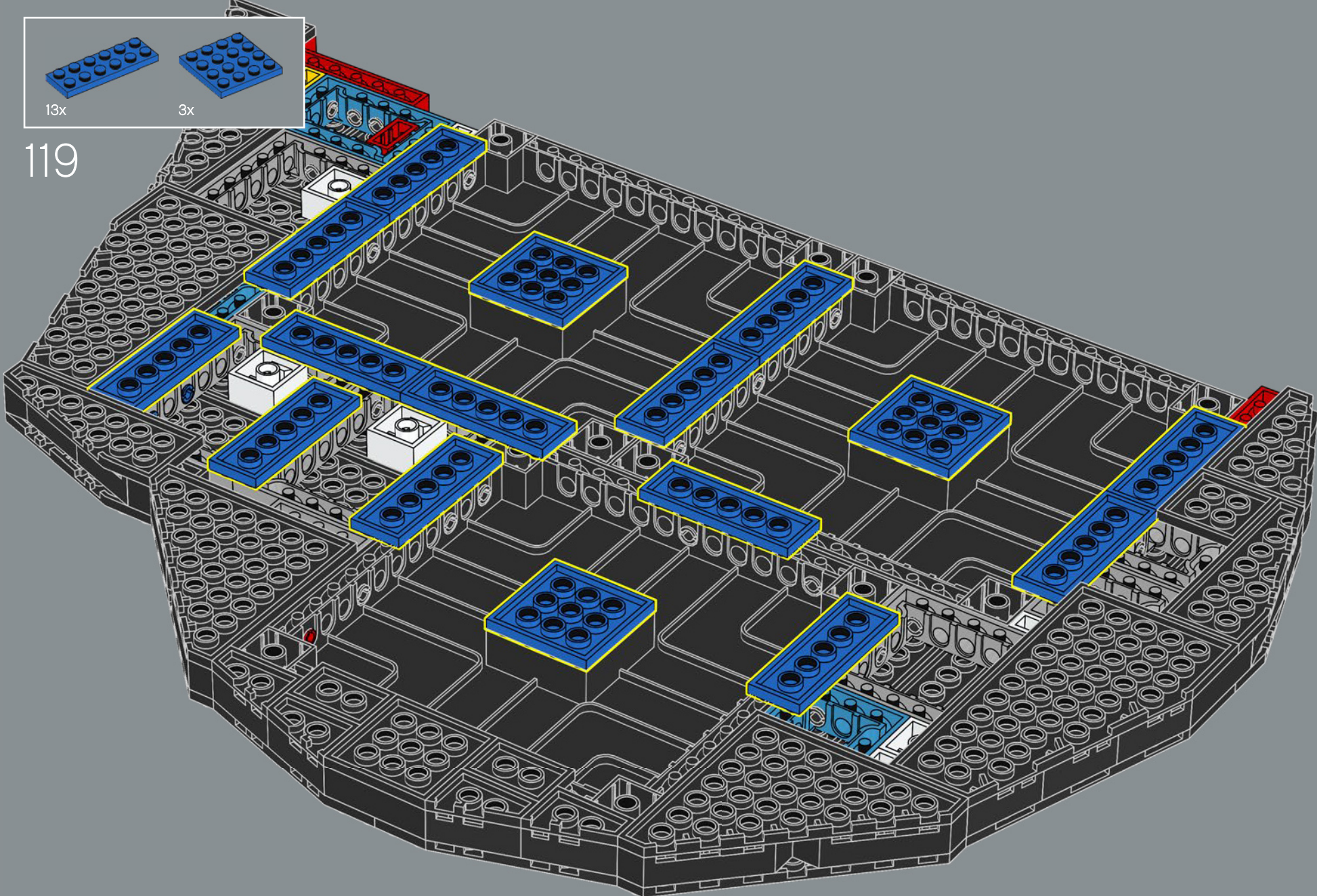



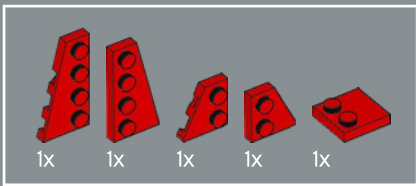

120

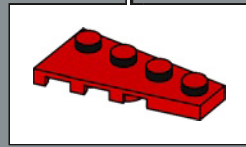
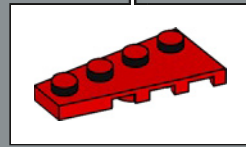
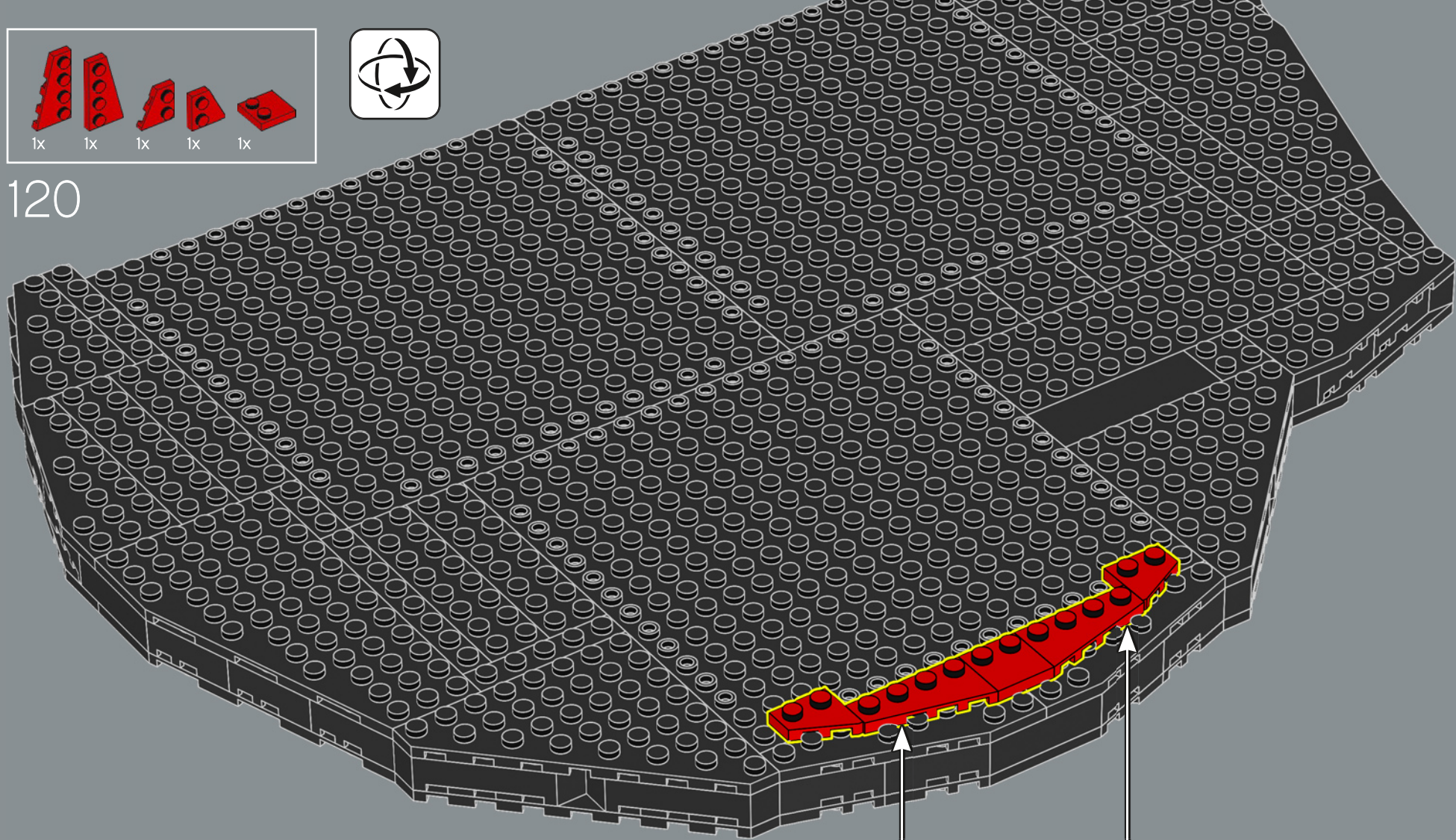

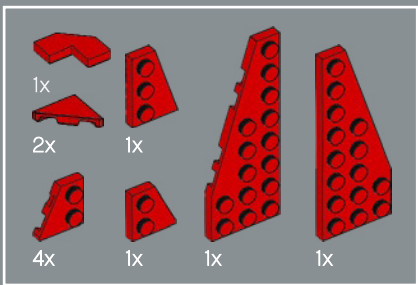

121

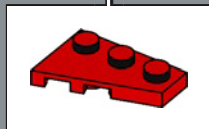
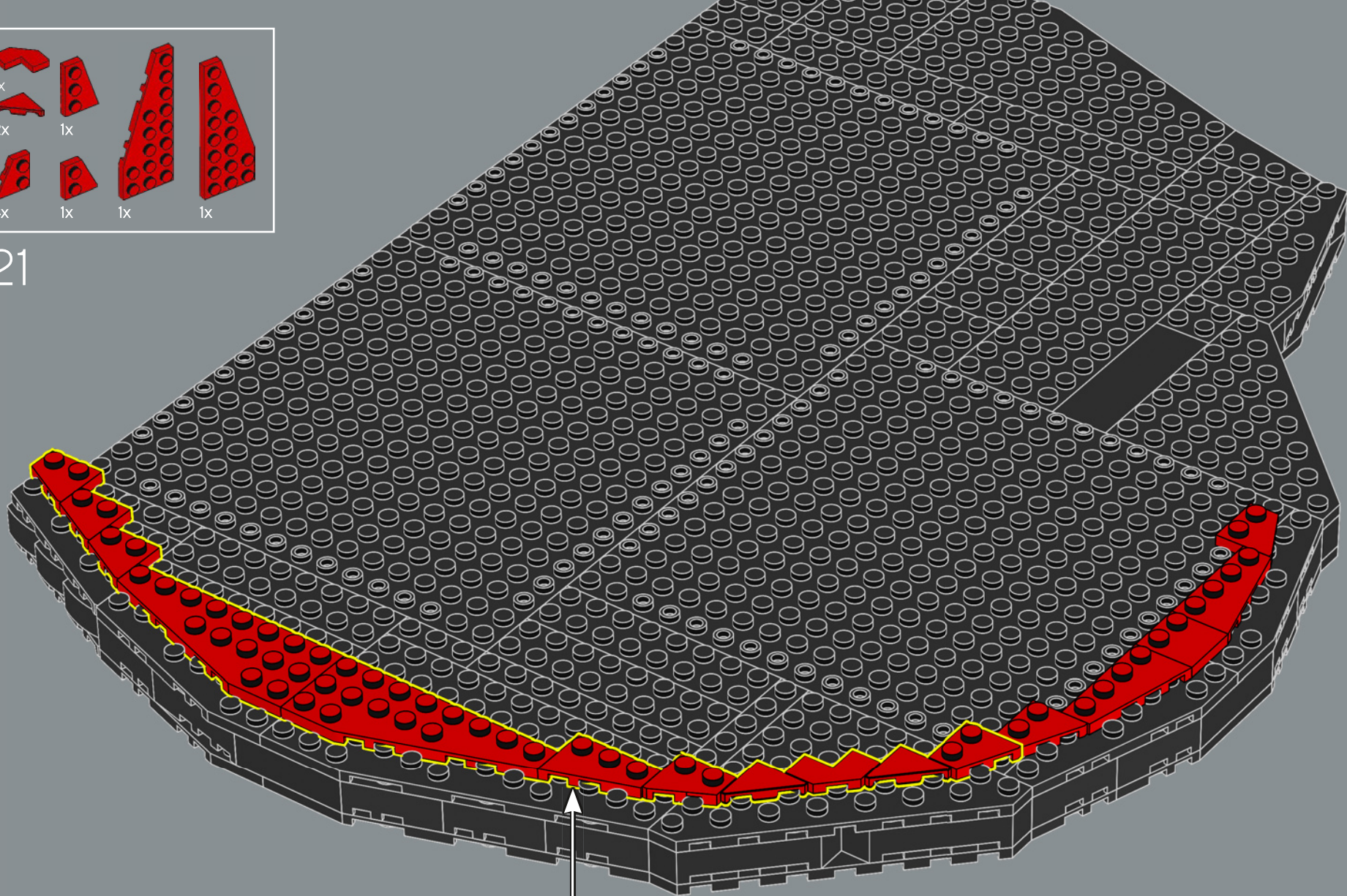

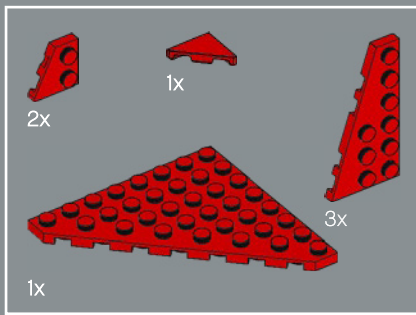

122

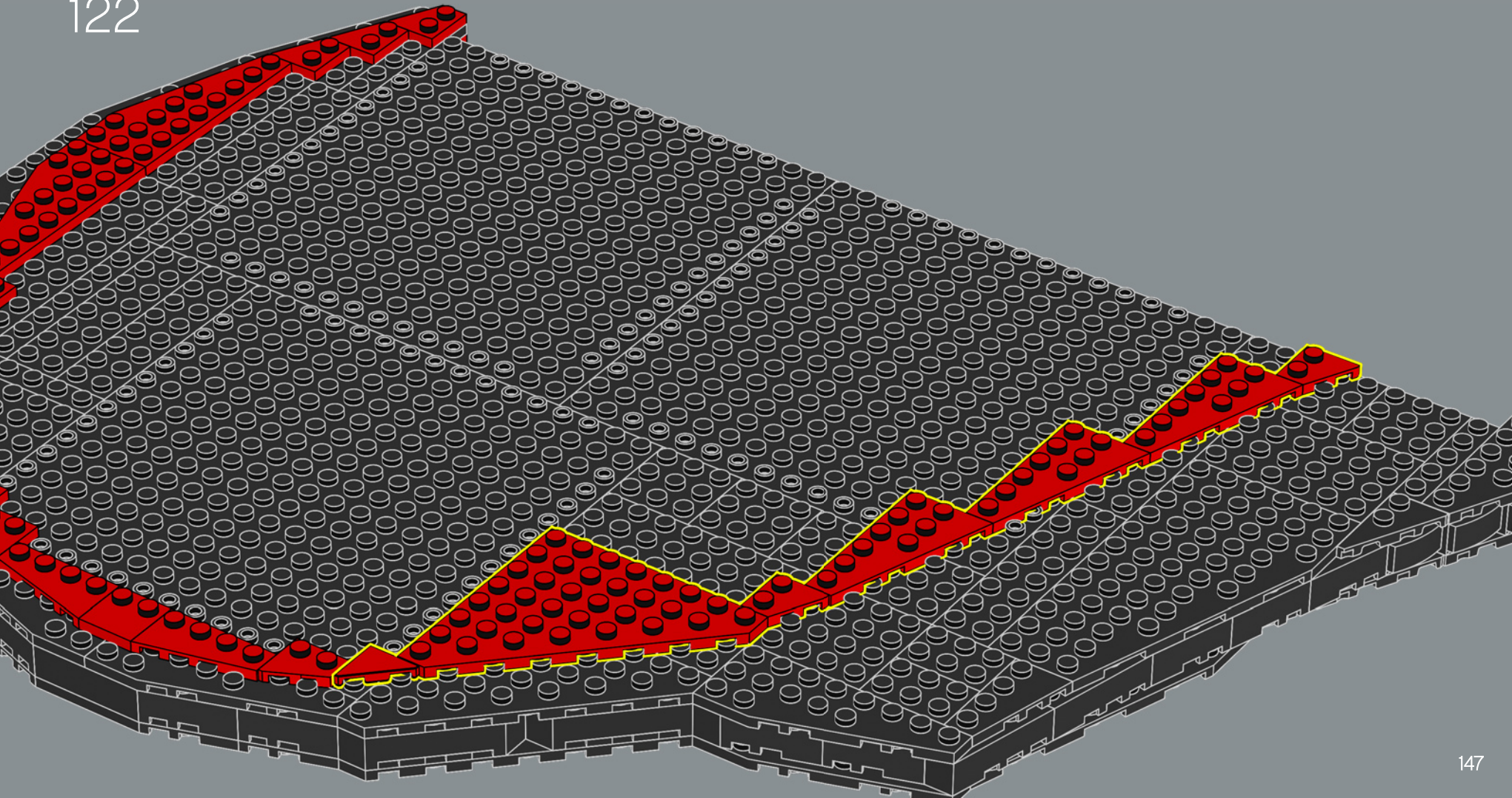

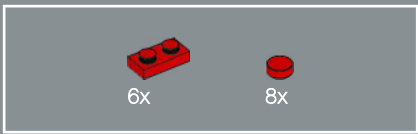

123

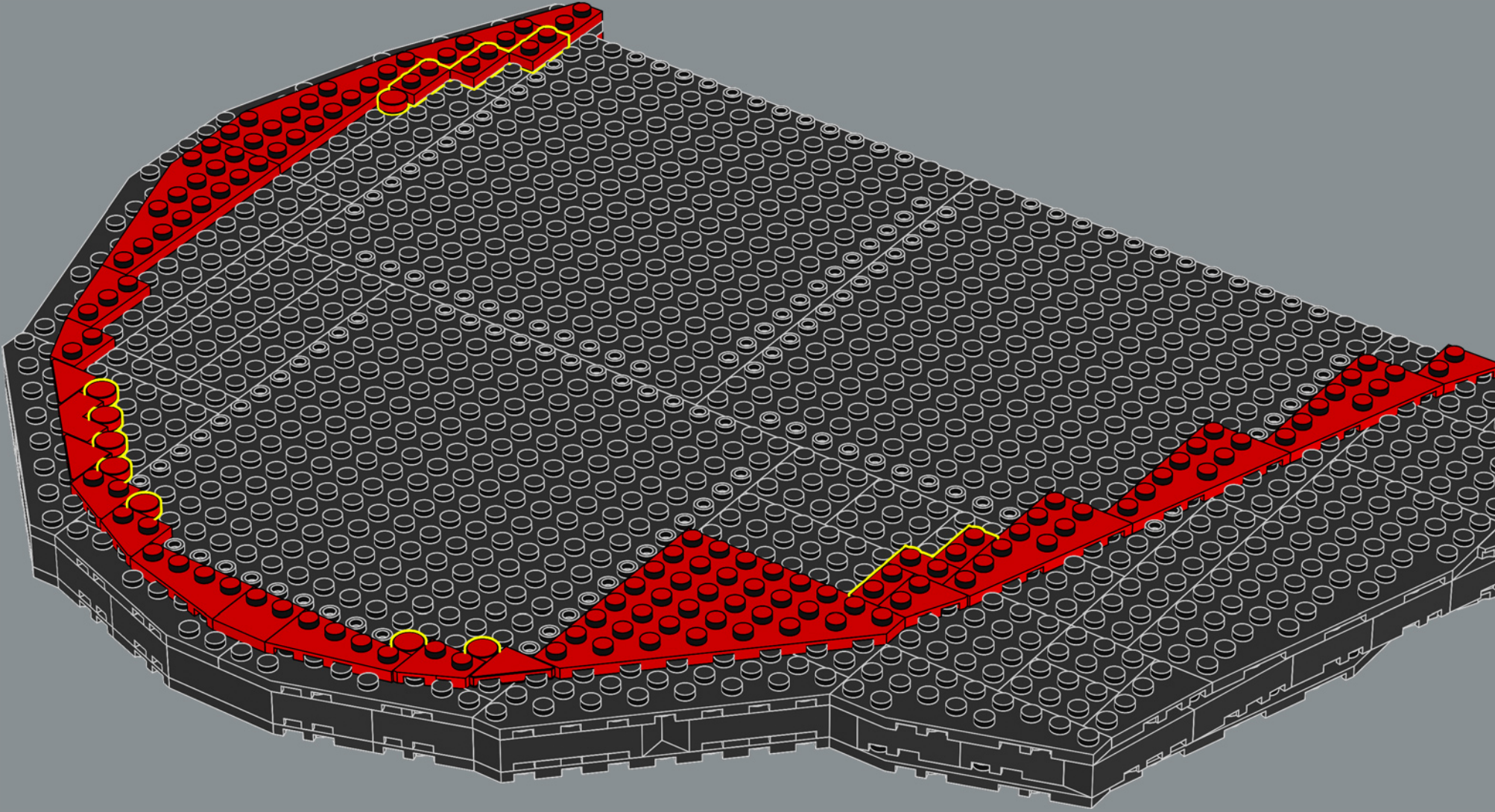

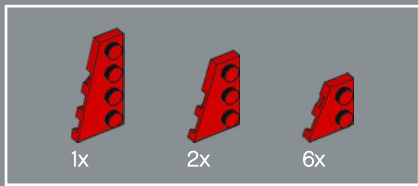

124

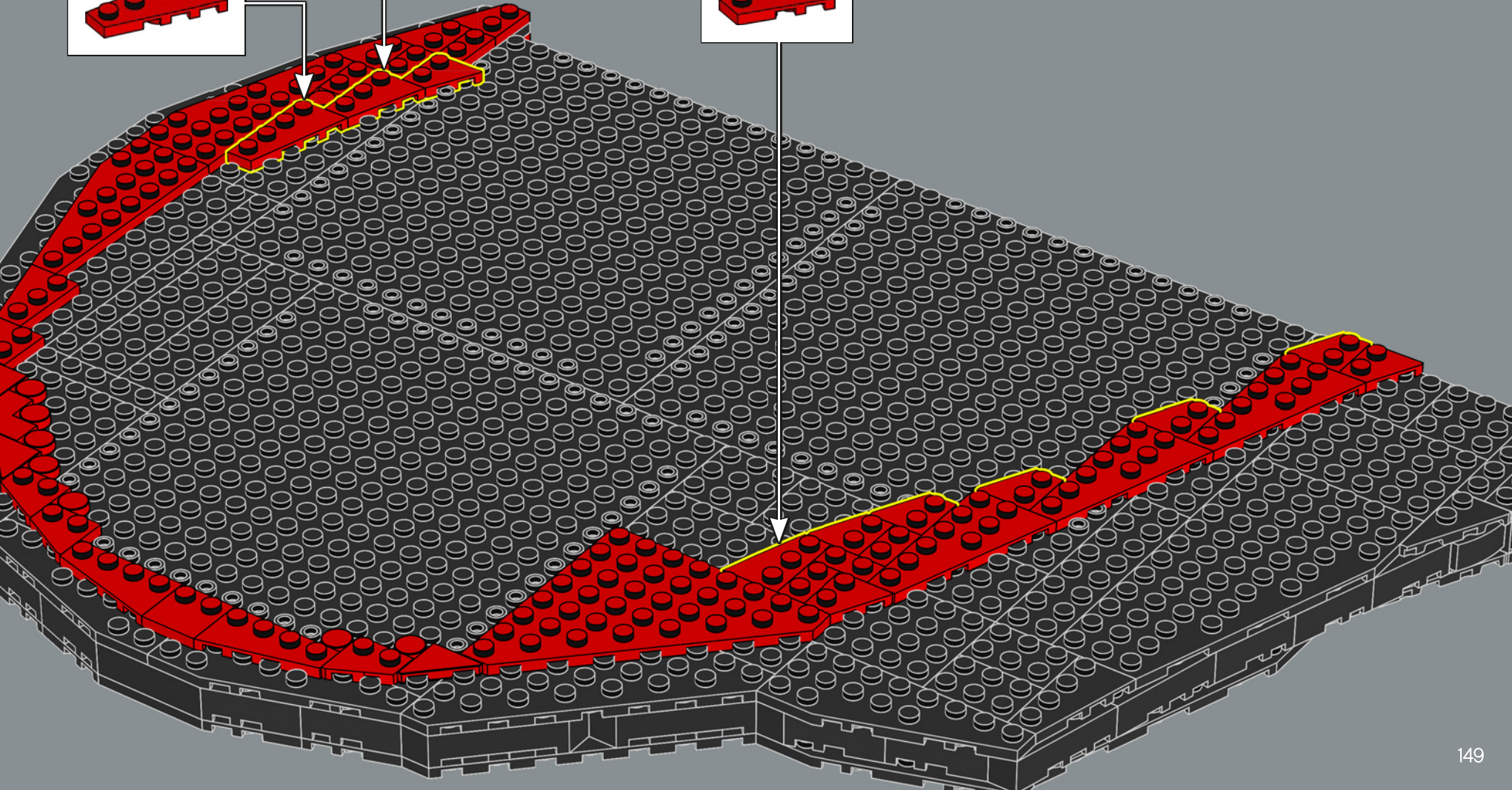
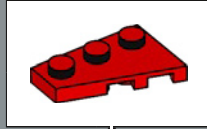
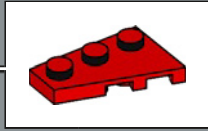
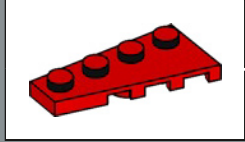

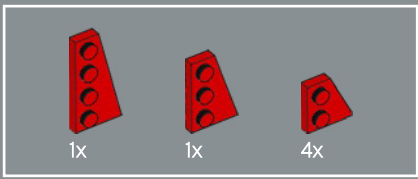

125

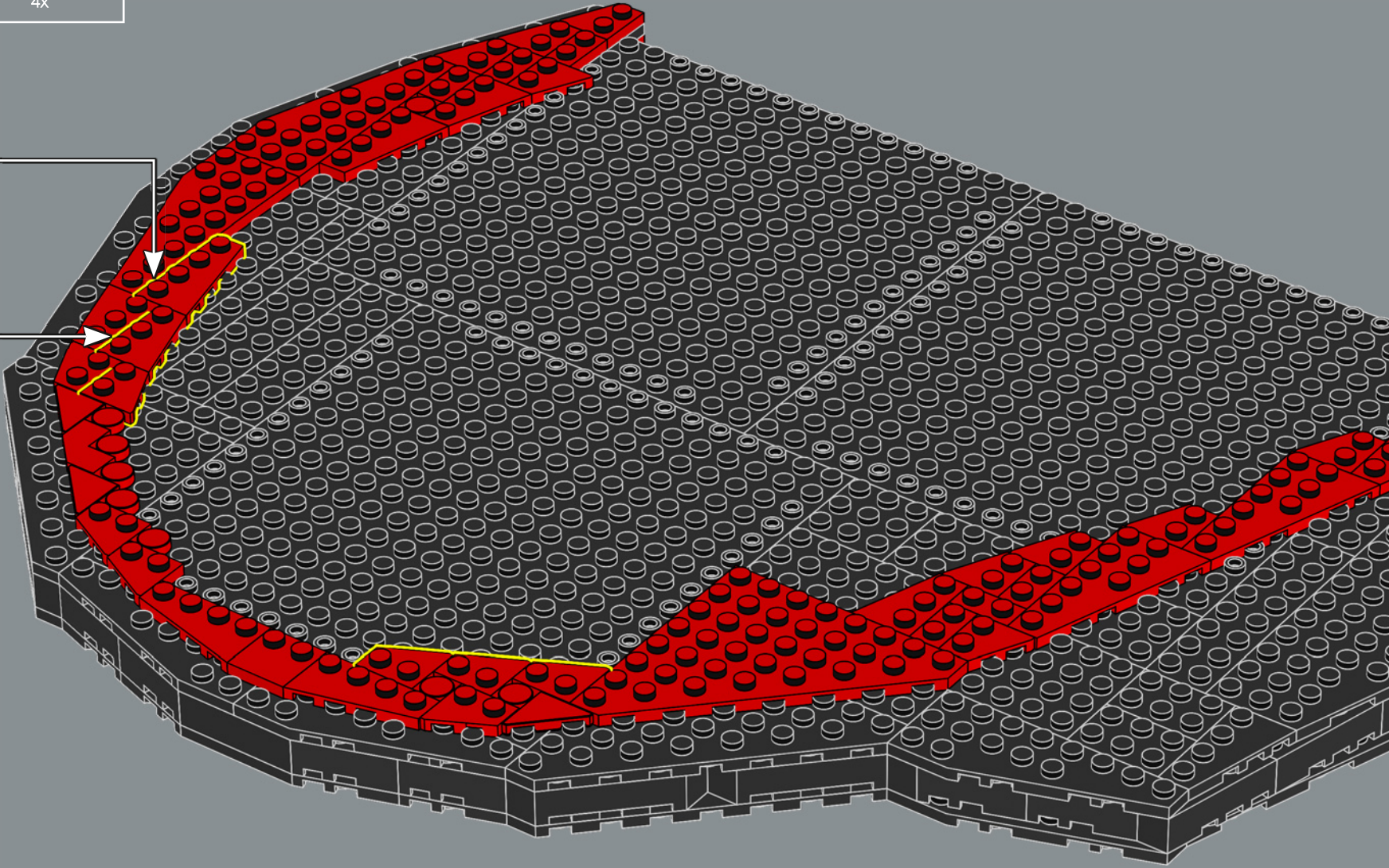
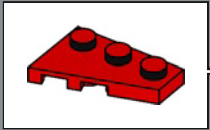
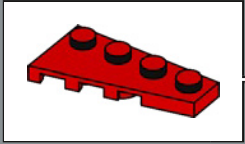



126

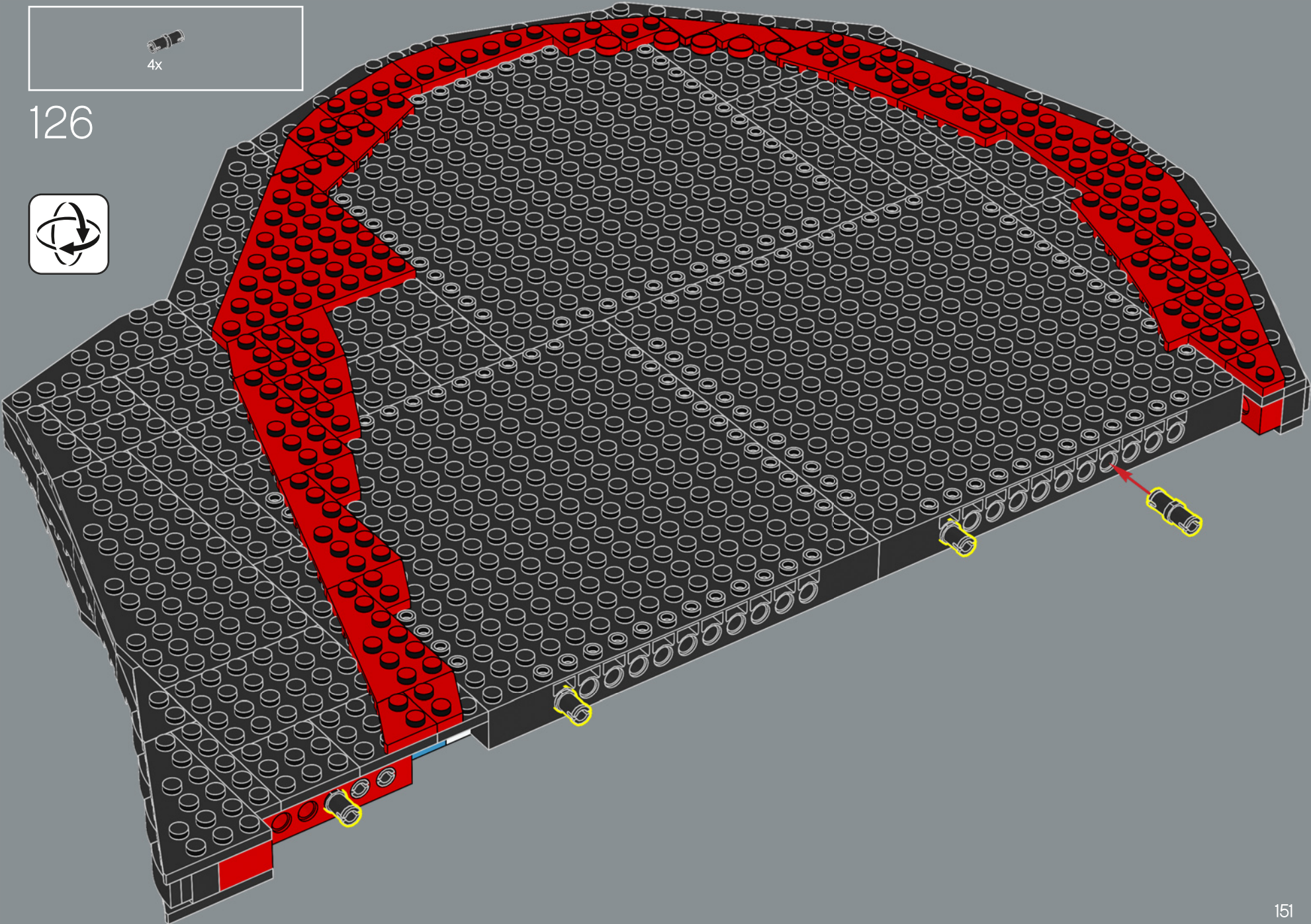

127

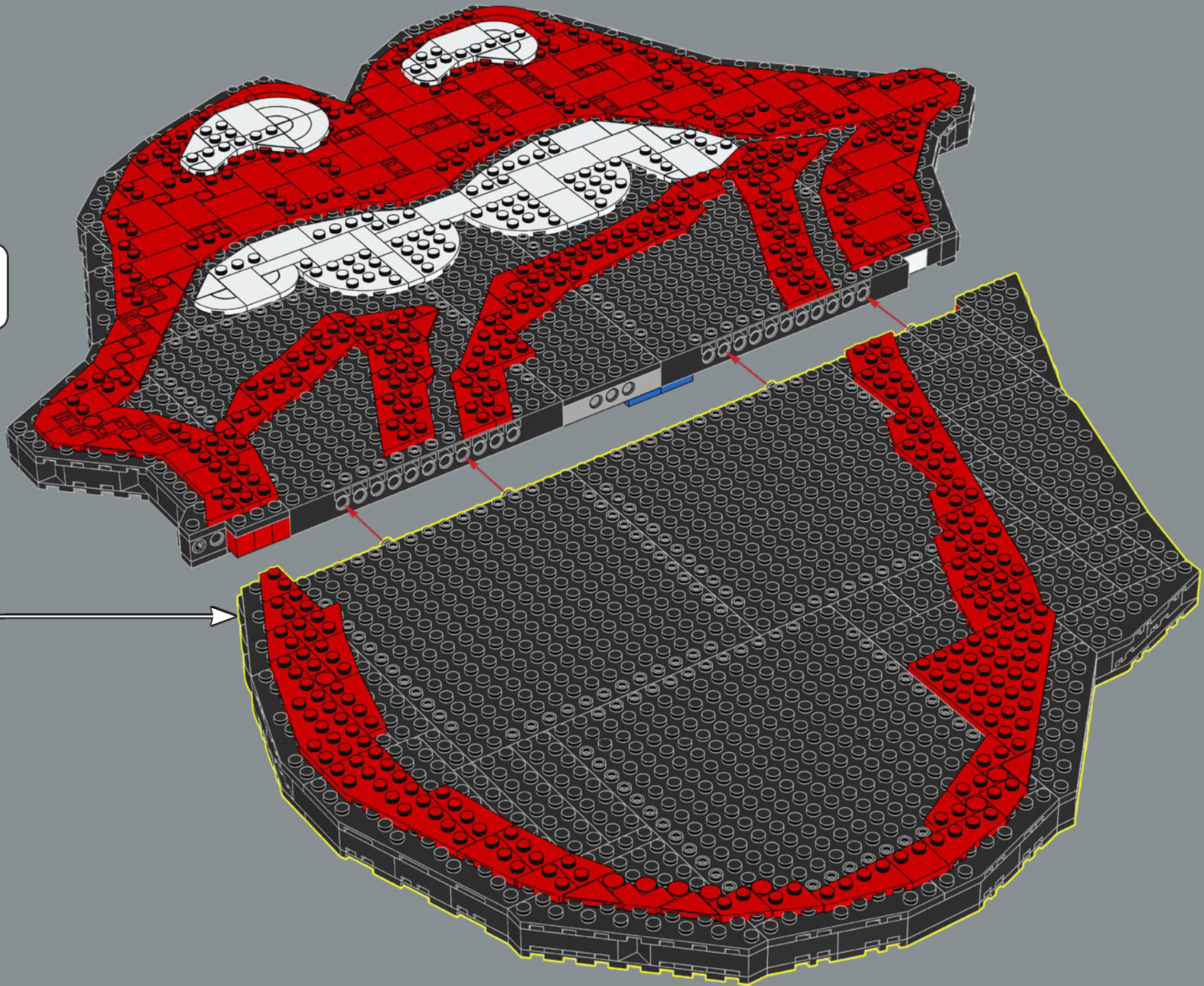

152

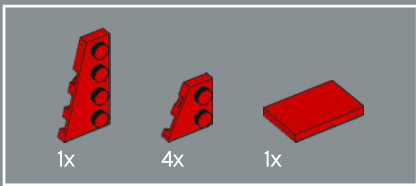

128

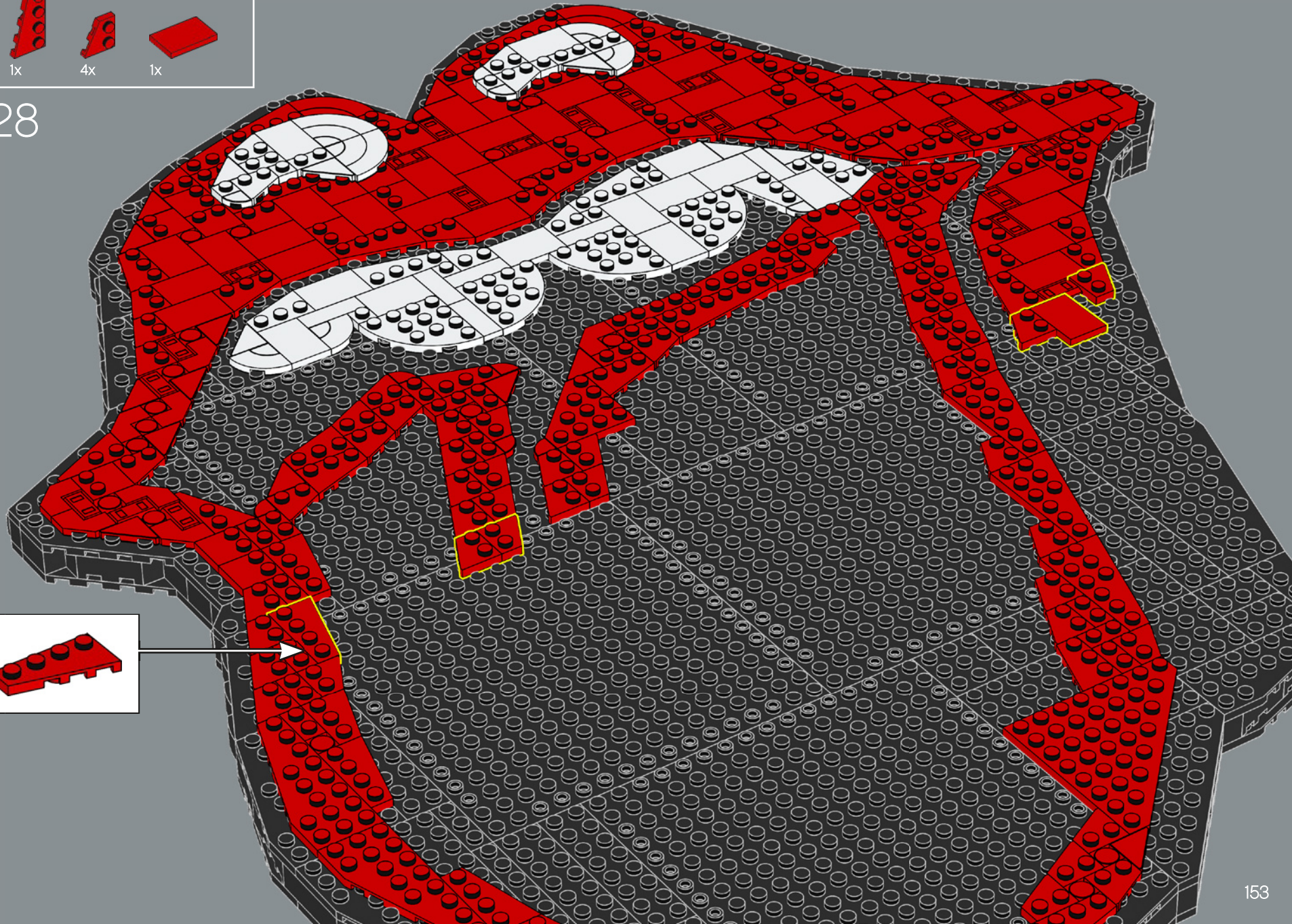
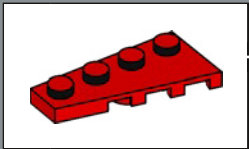

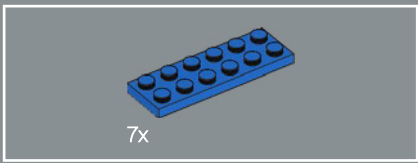

129

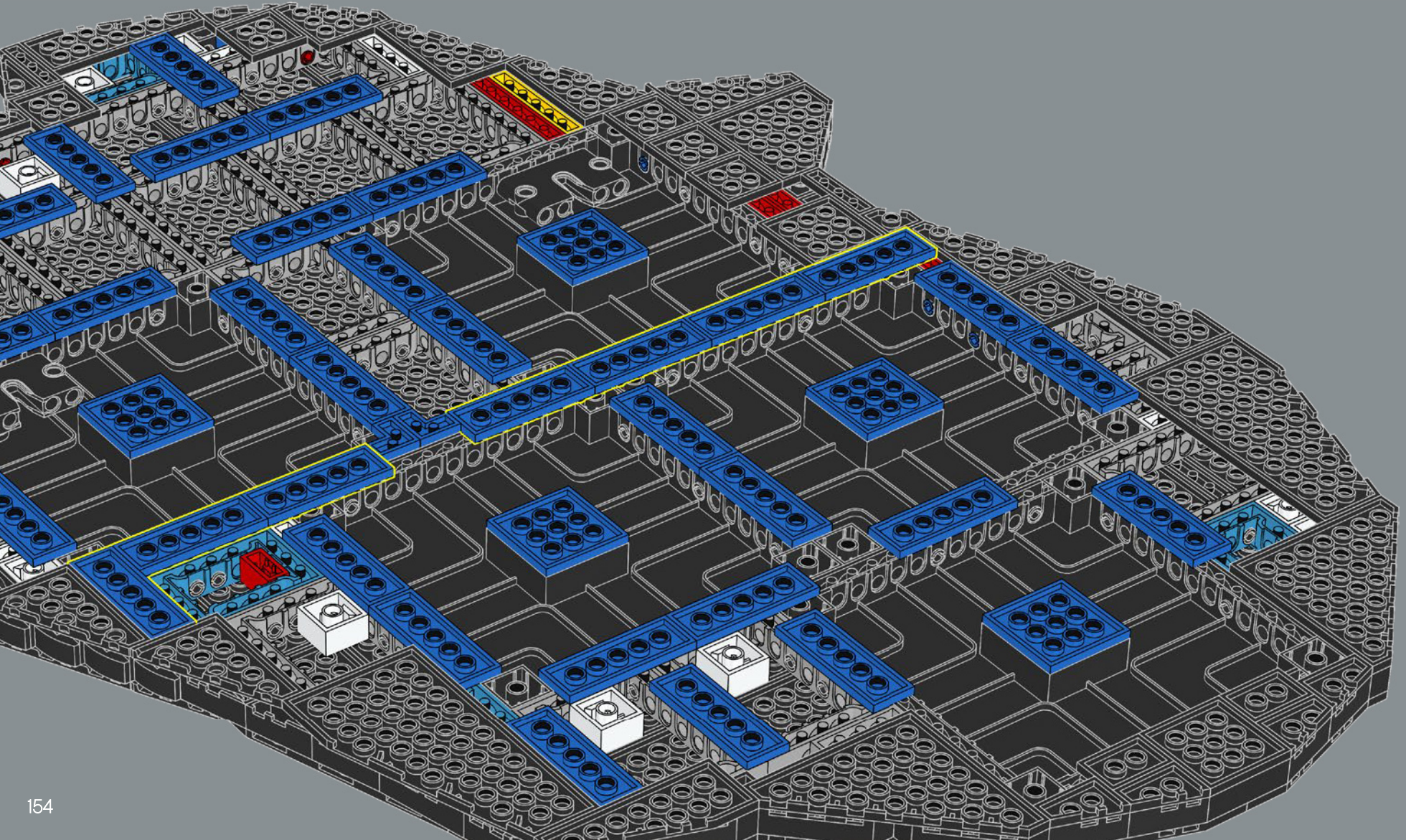

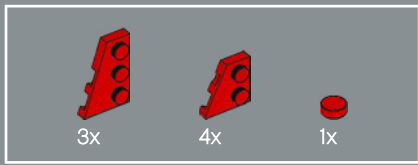

130

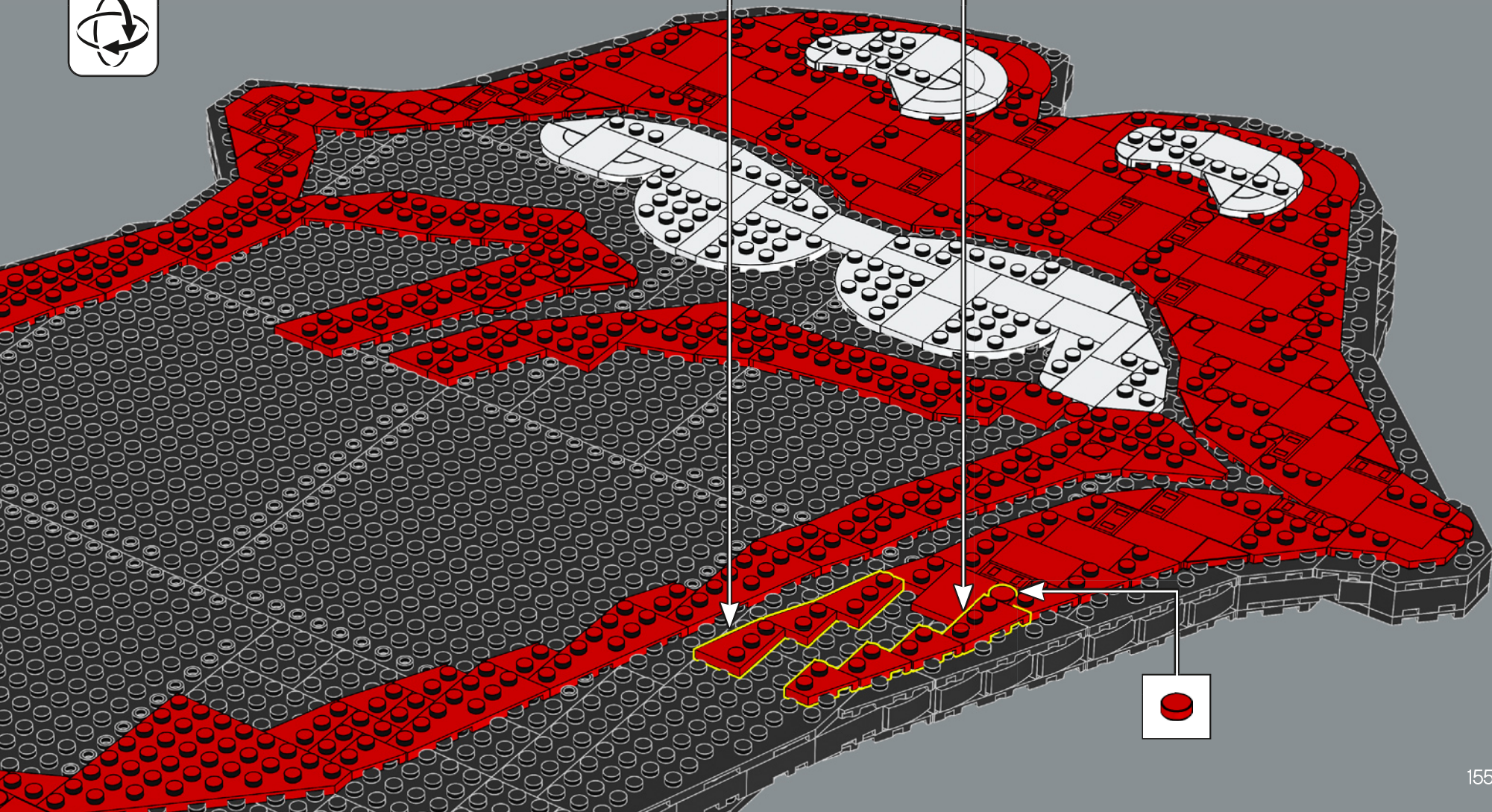
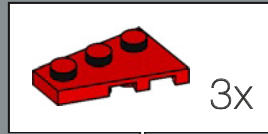

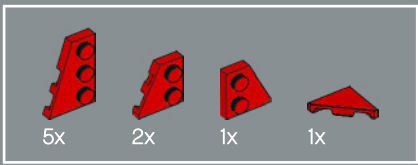

131

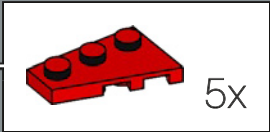
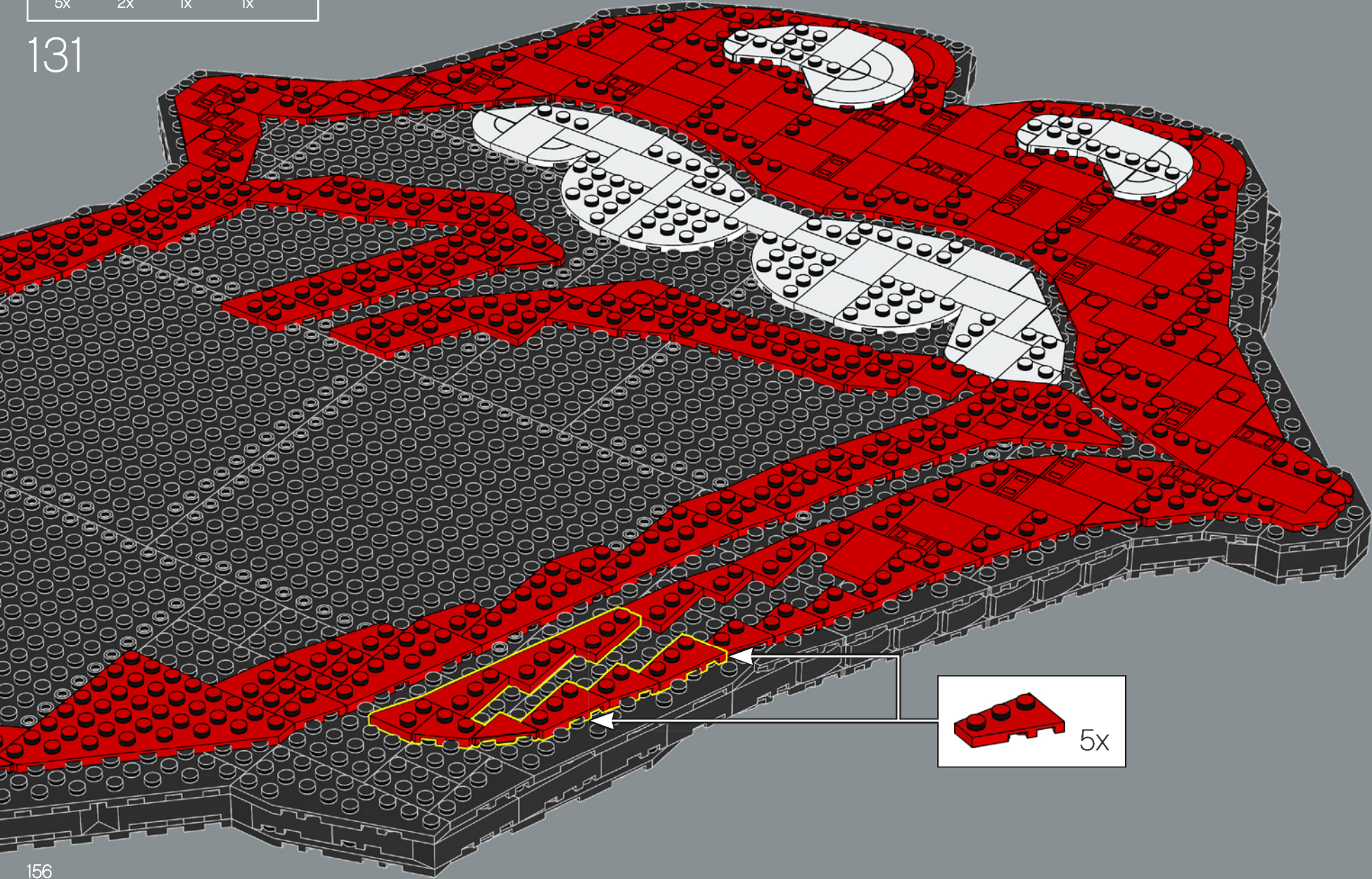

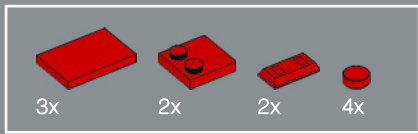

132

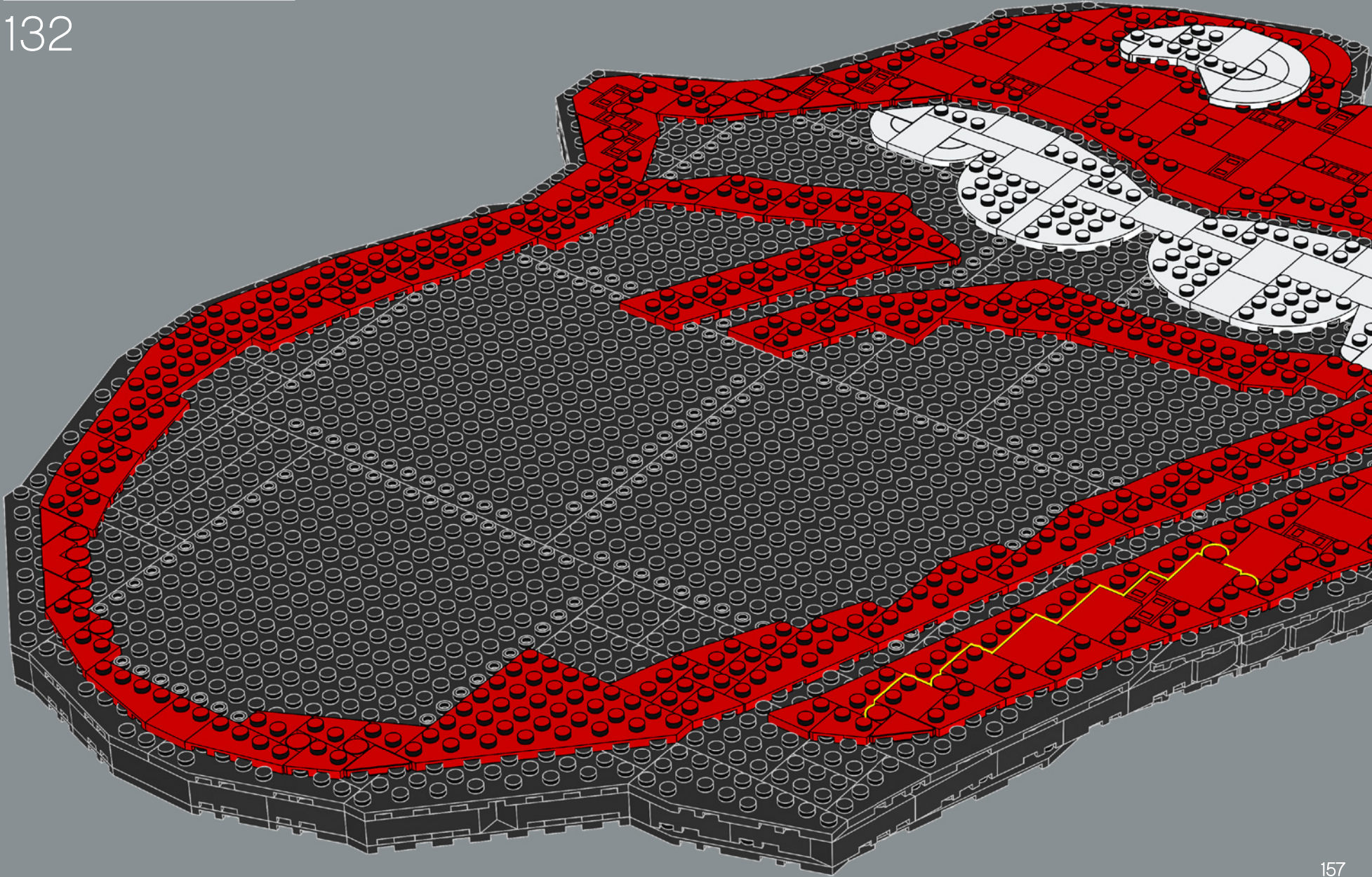

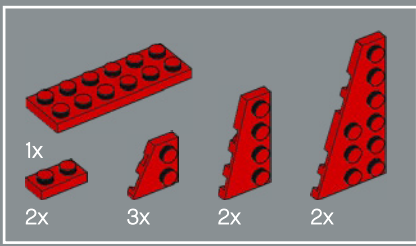

133

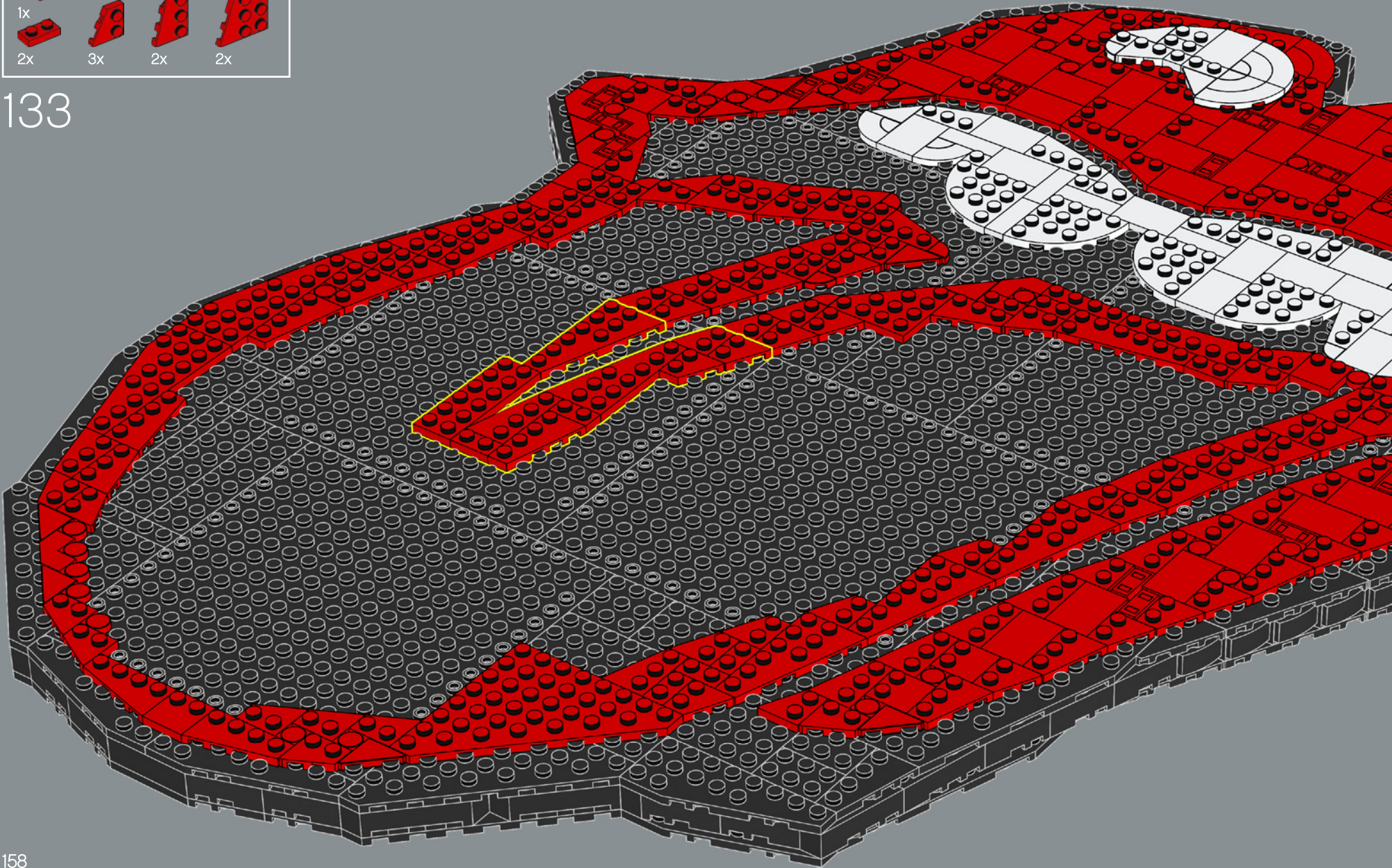





134

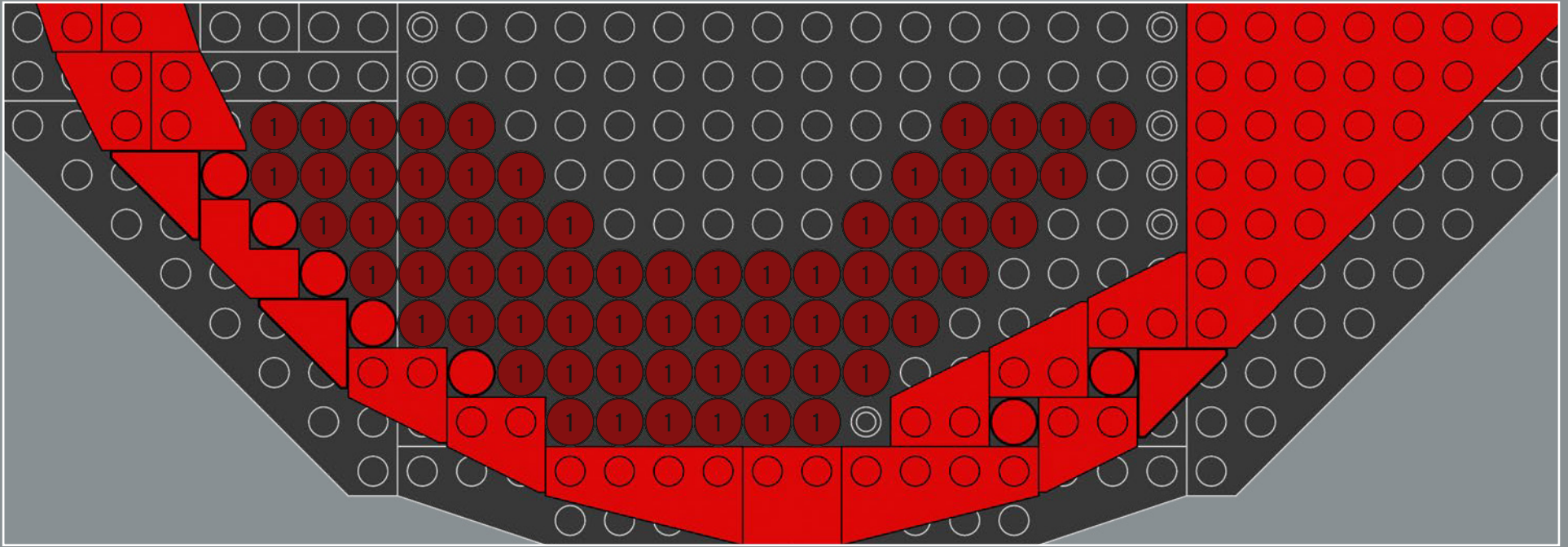
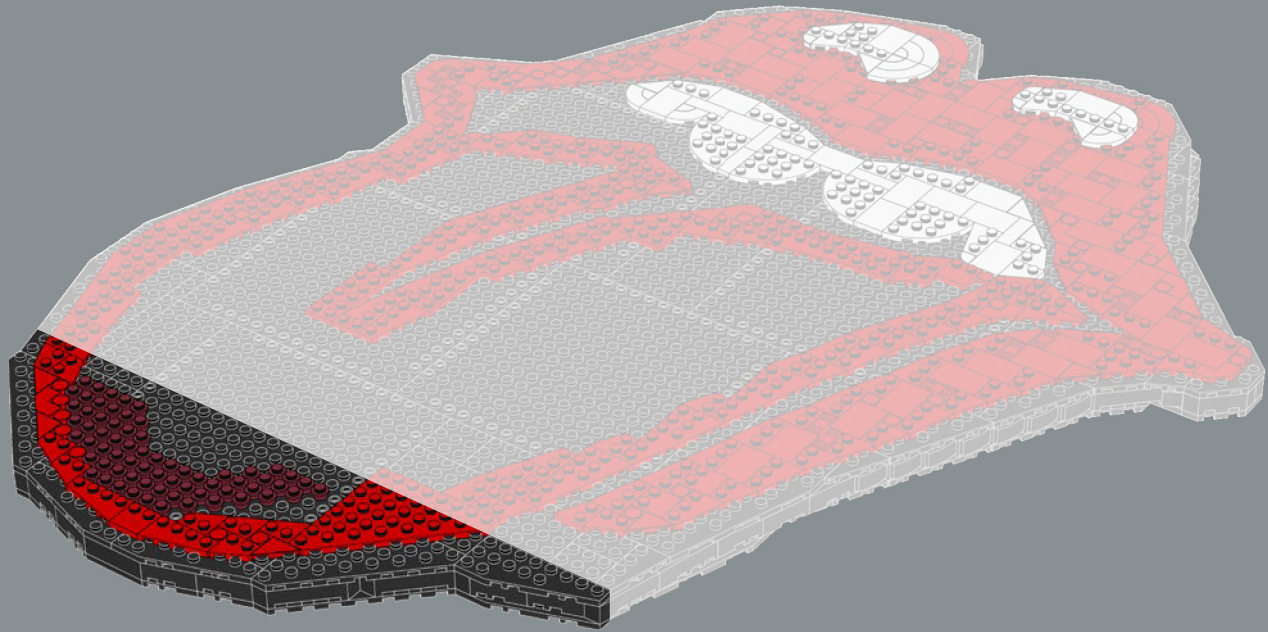

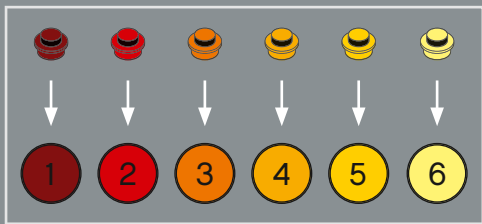

135

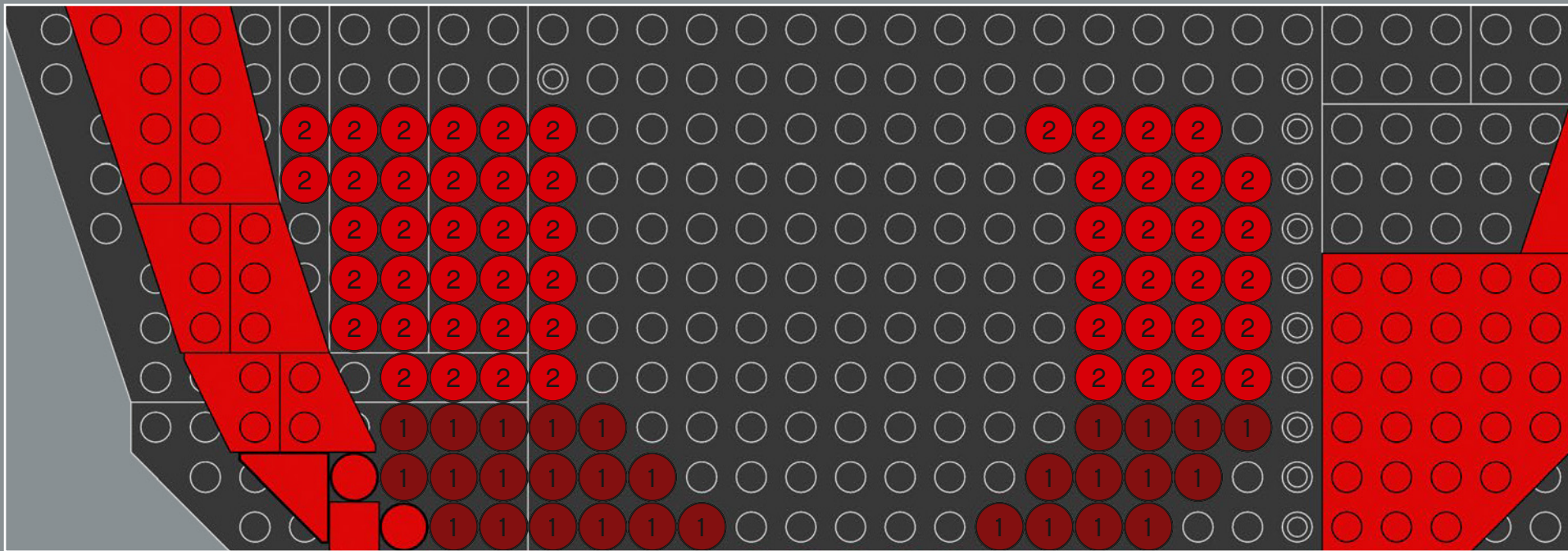
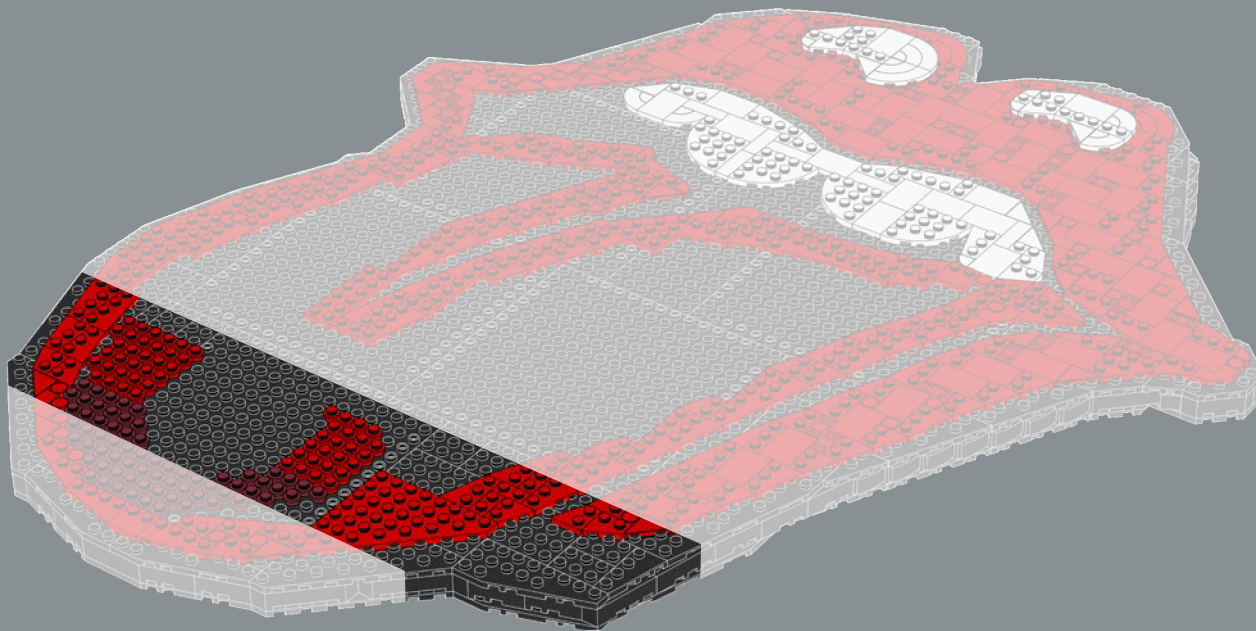

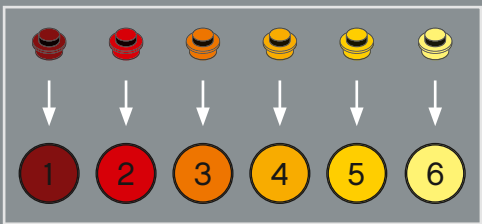

136

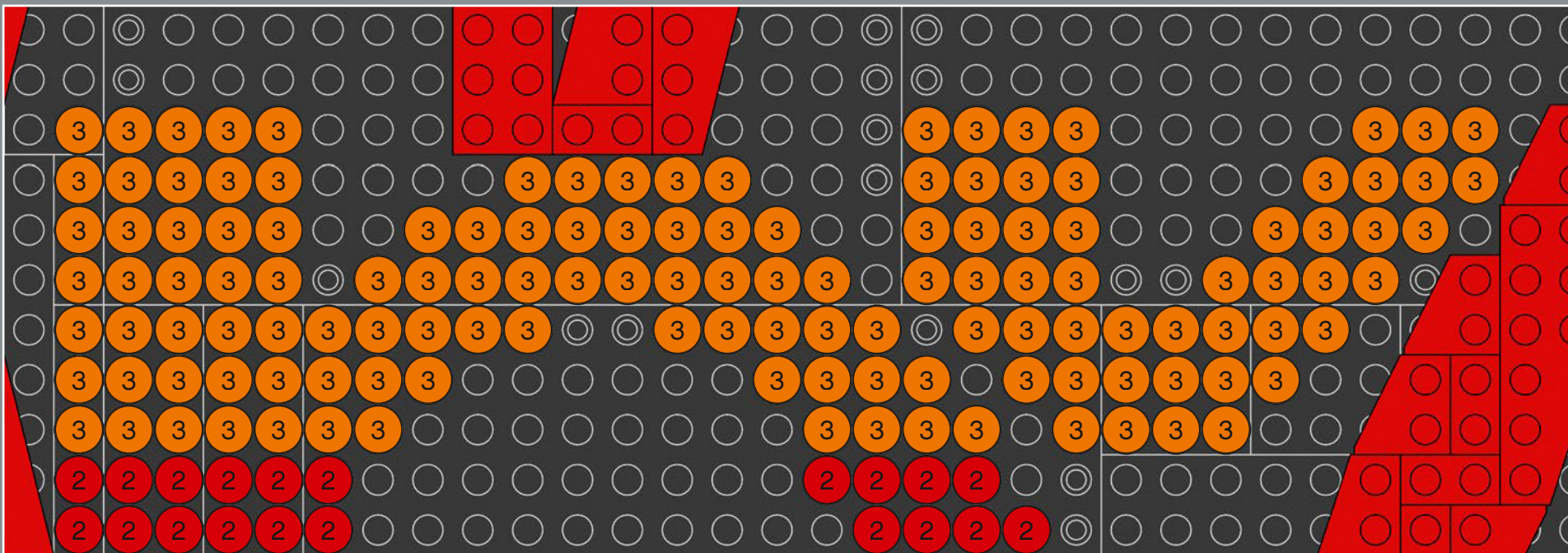
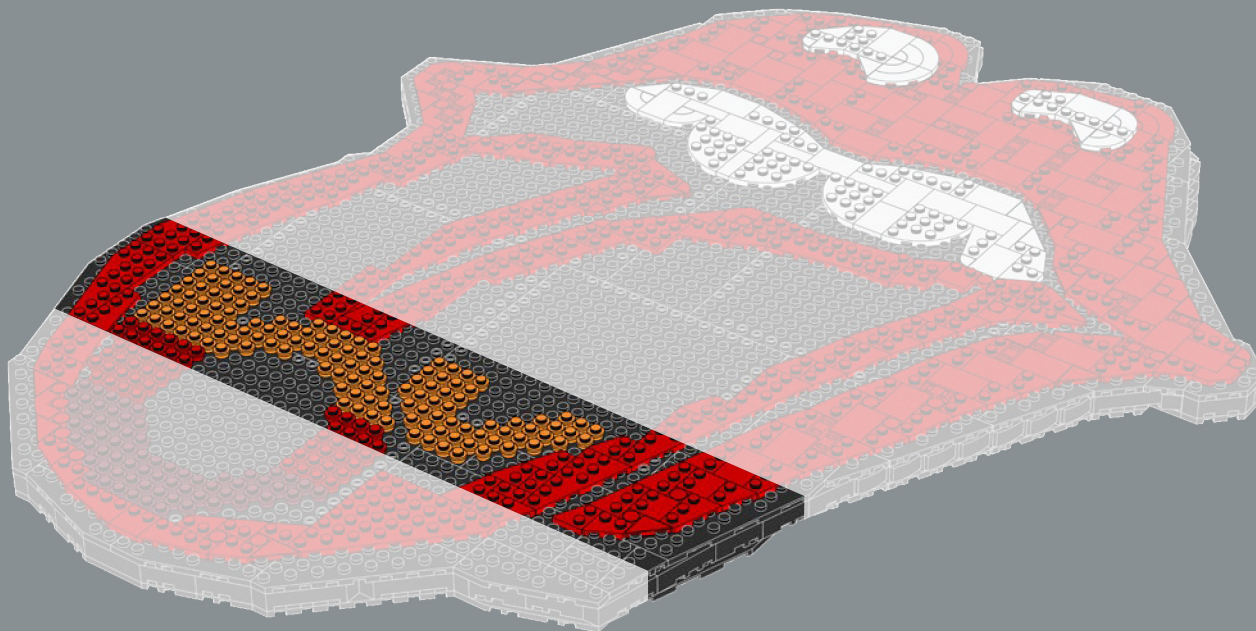



137

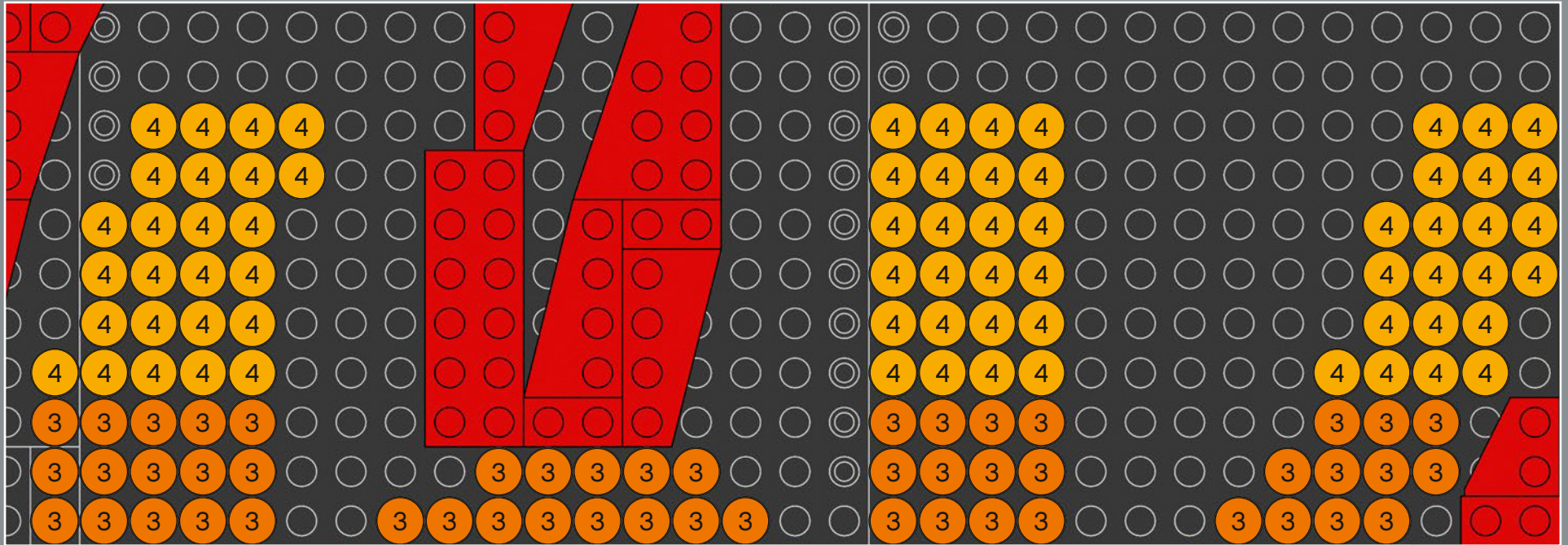
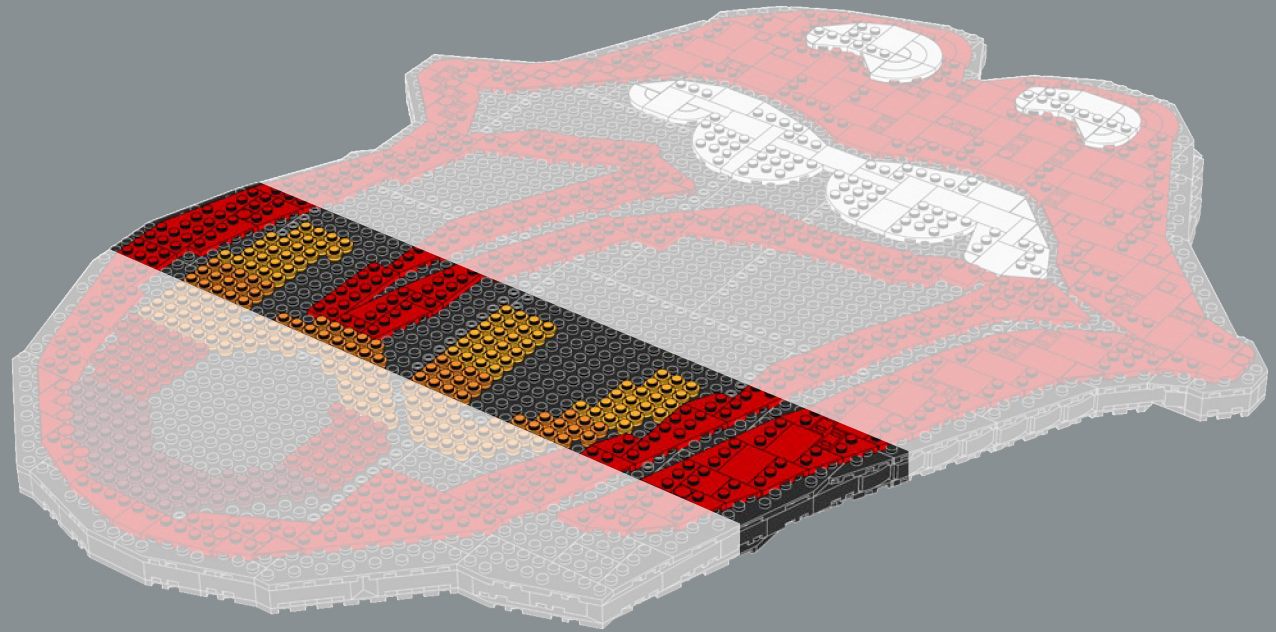



138

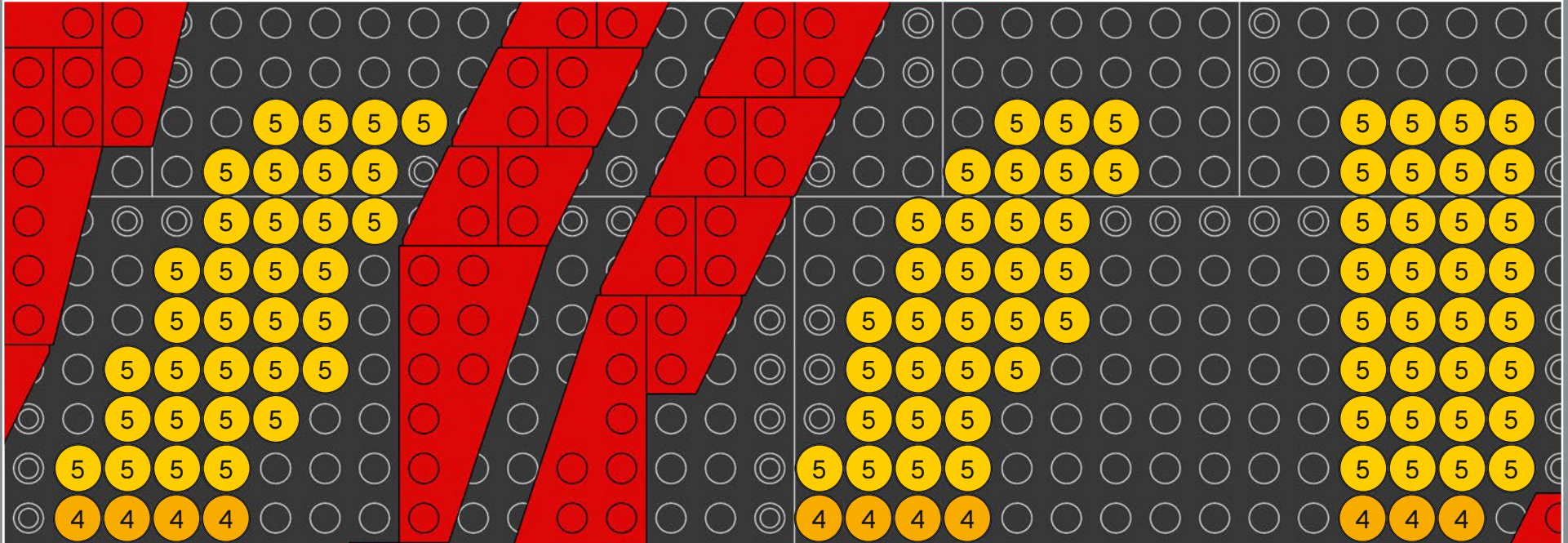
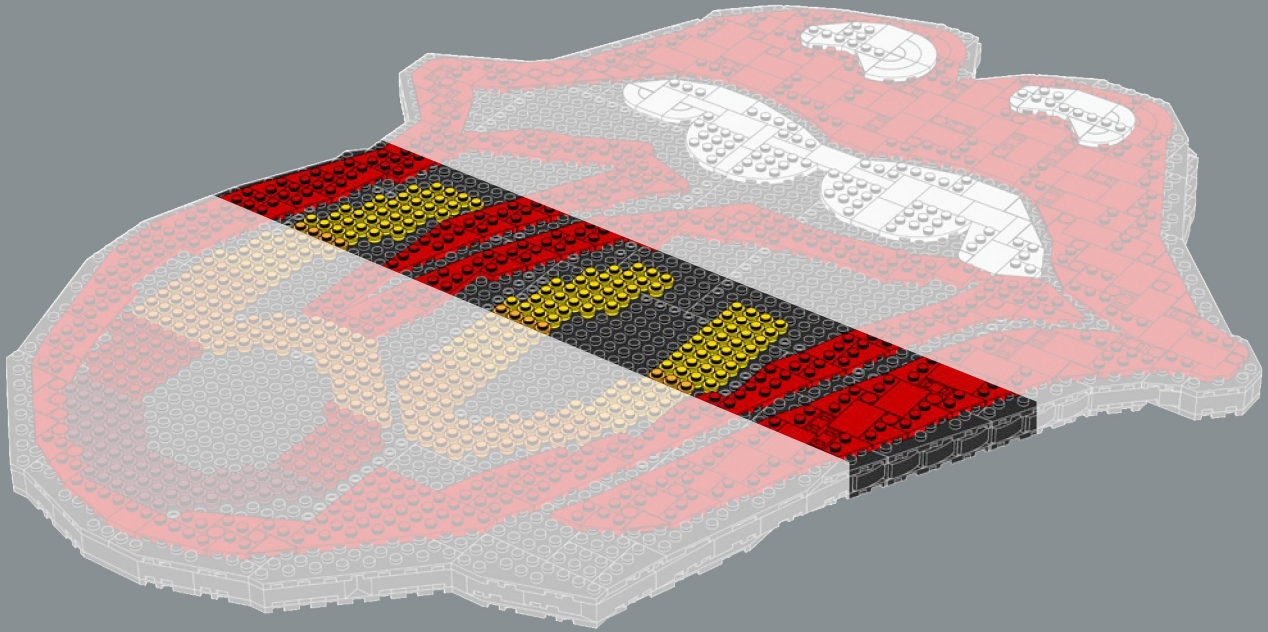

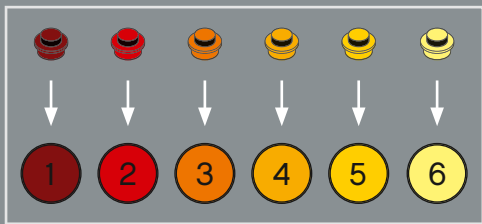

139

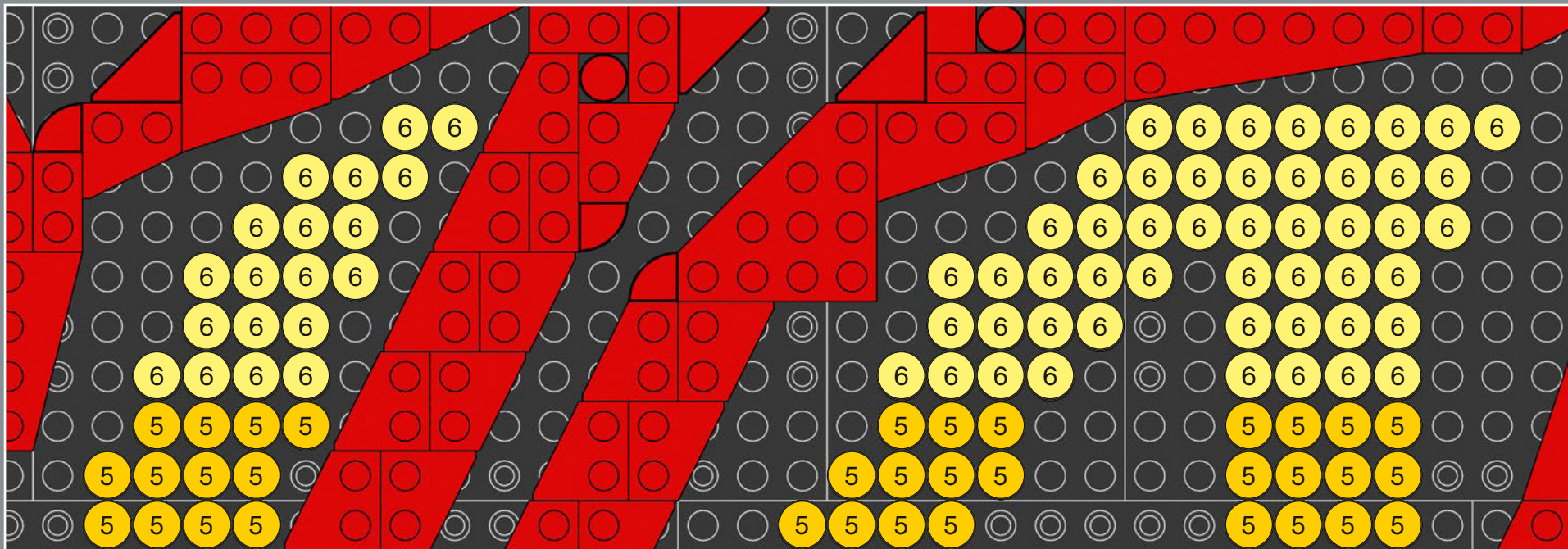
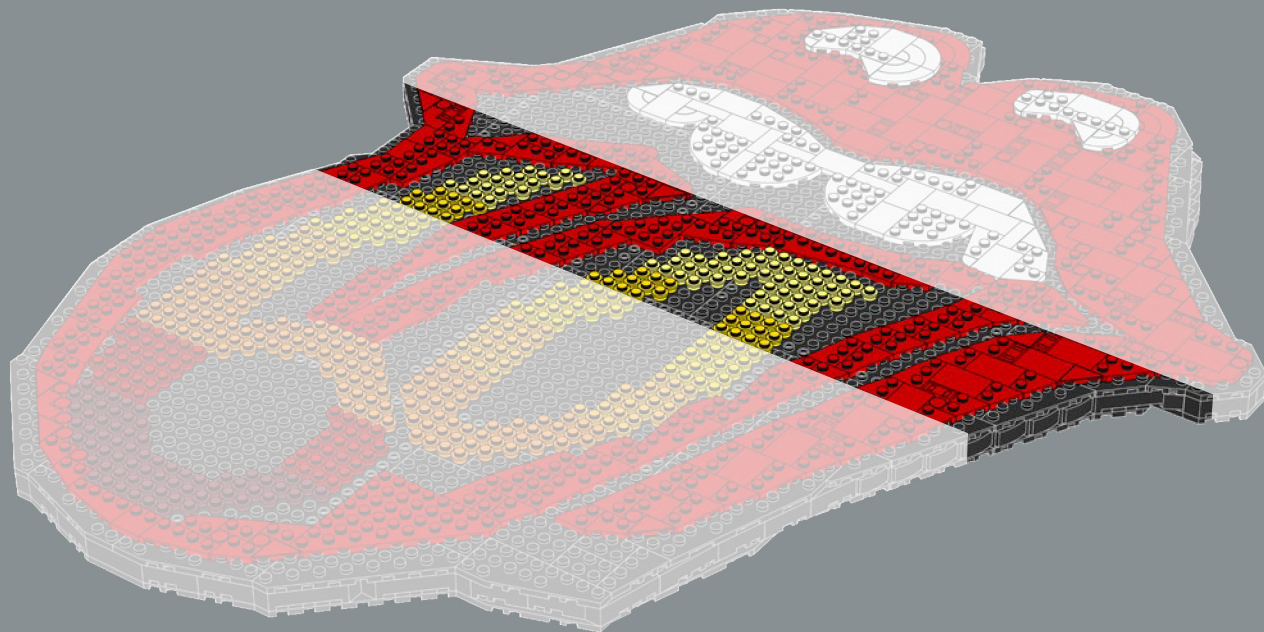

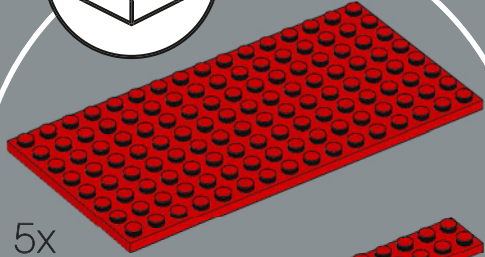
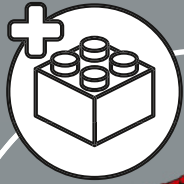

5x

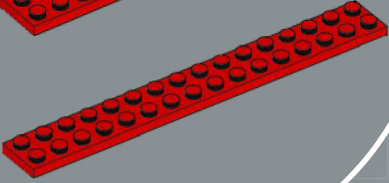

1x



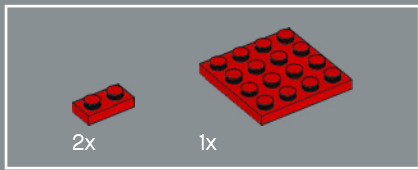

140

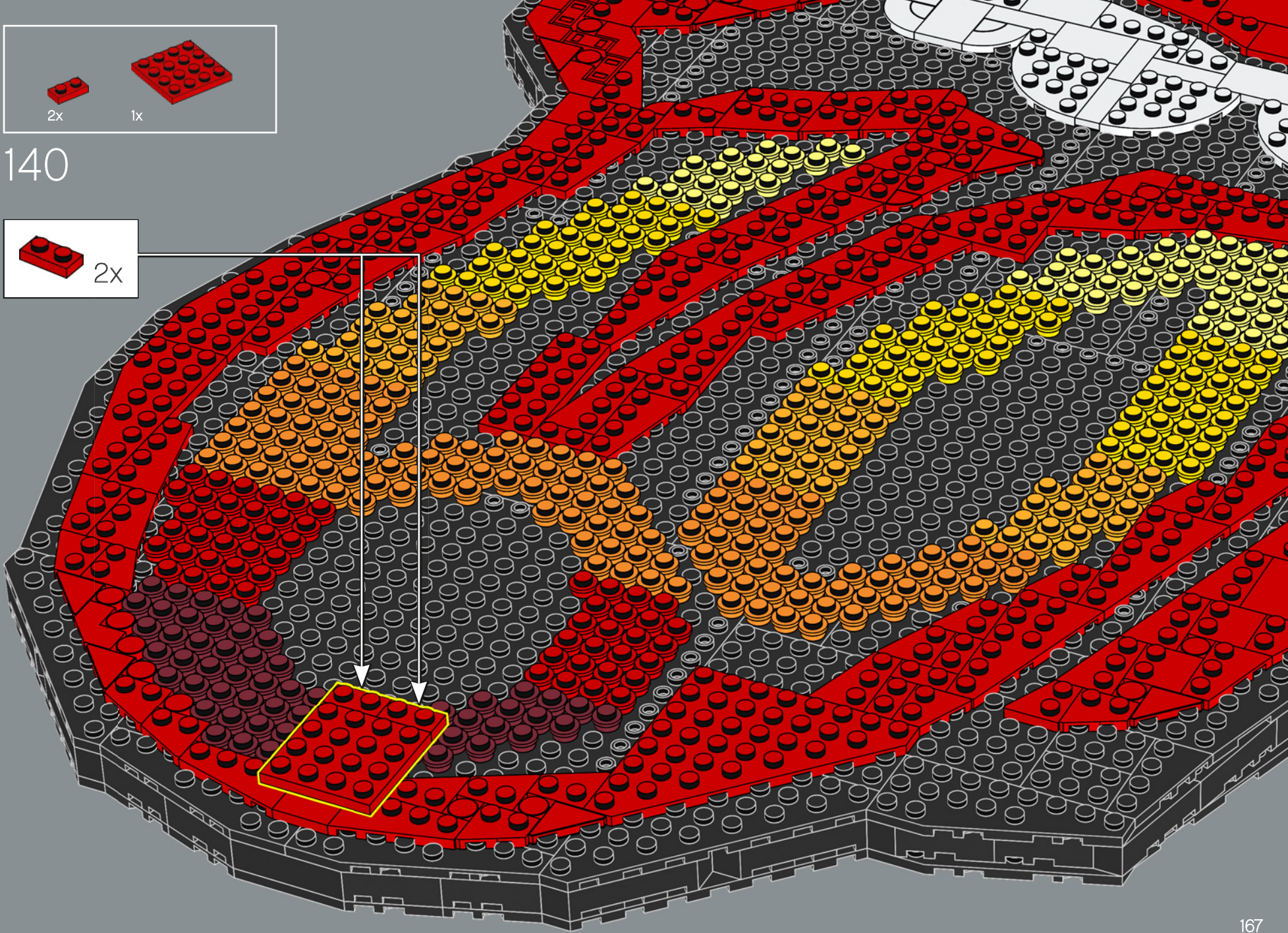
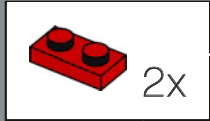

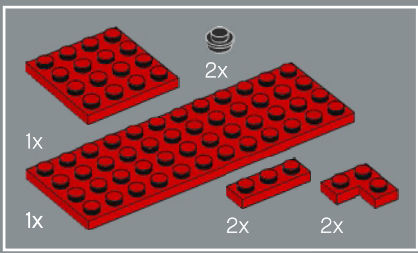

141

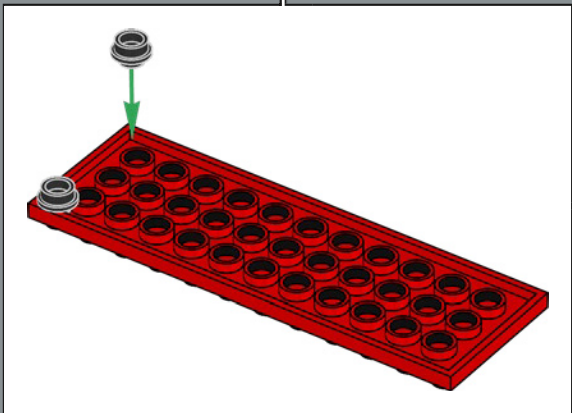
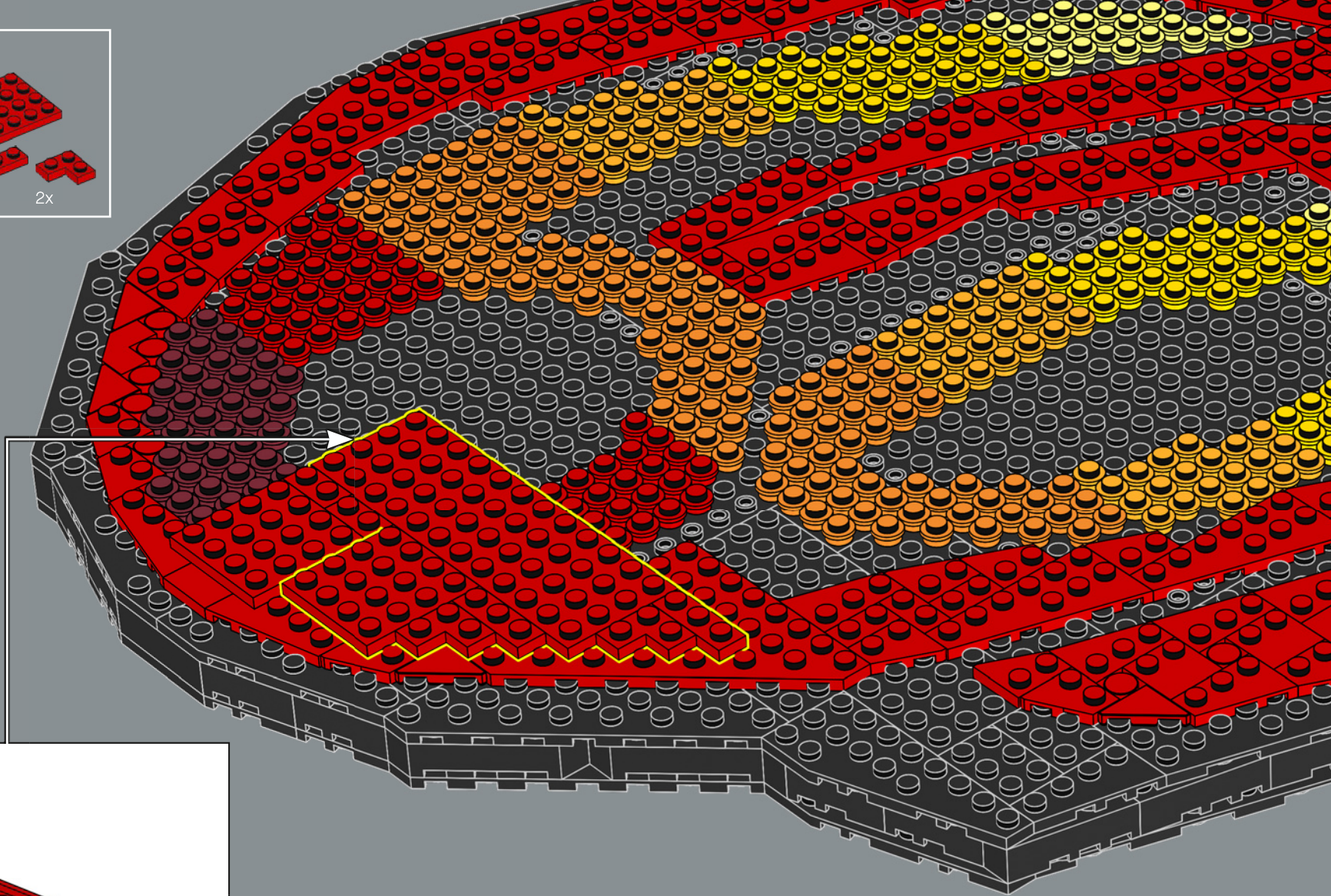

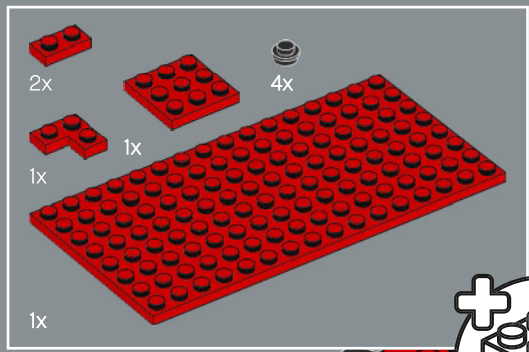

142

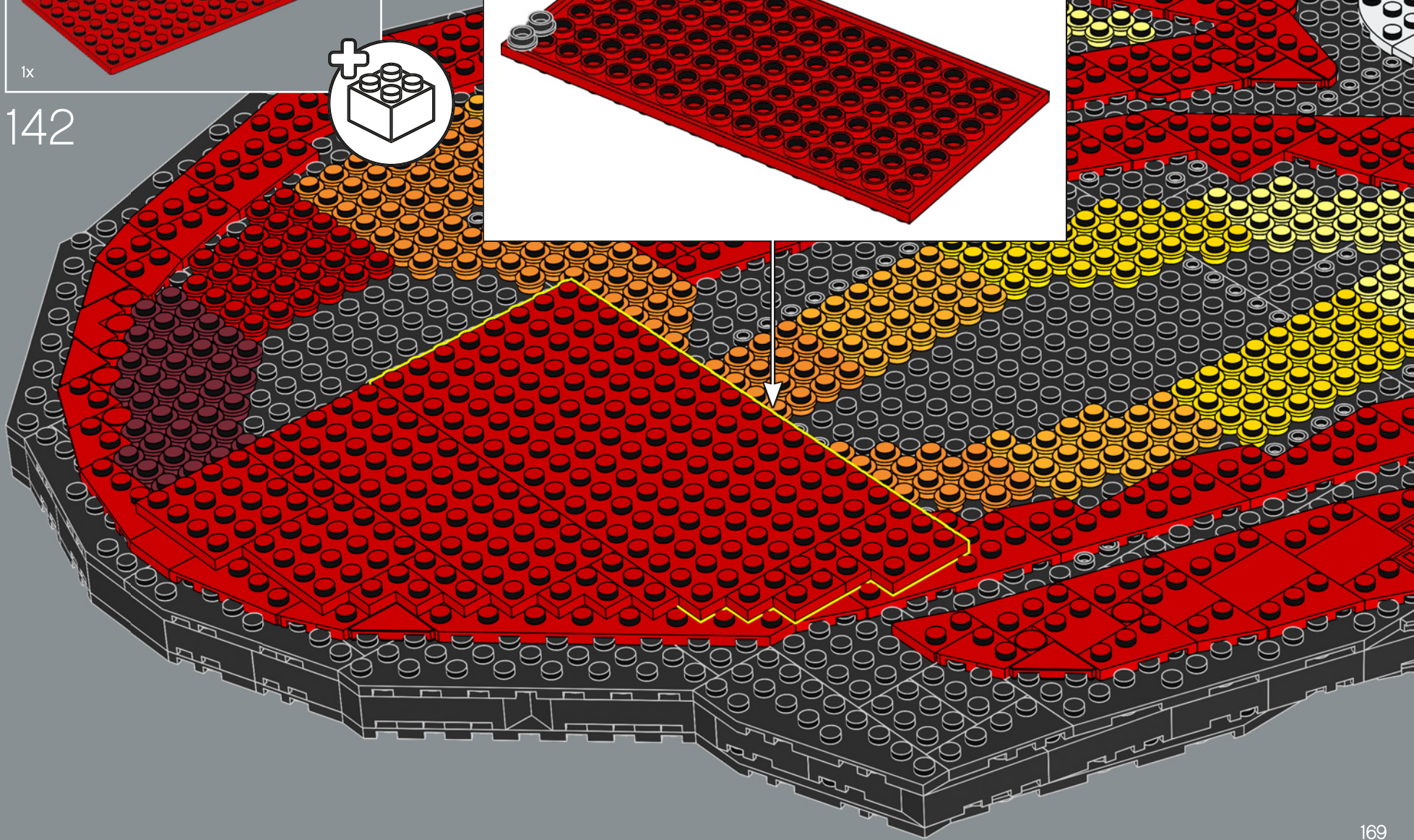
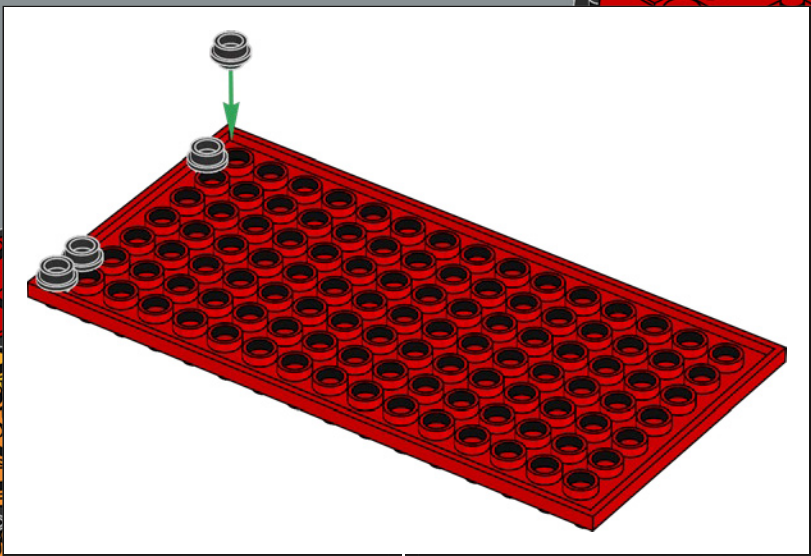

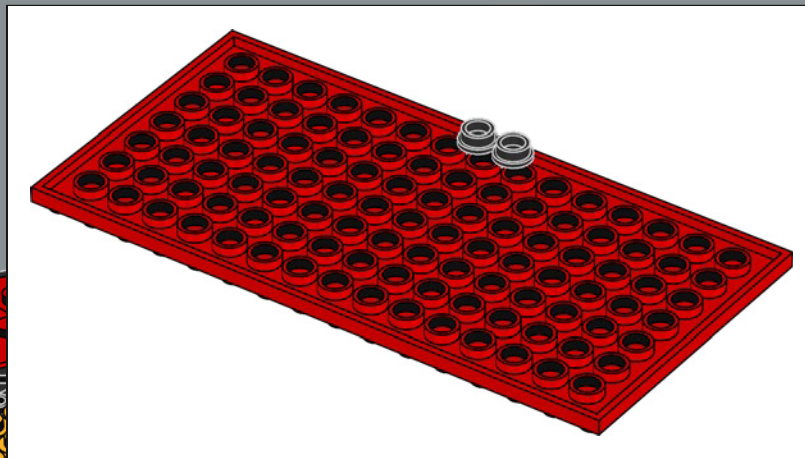
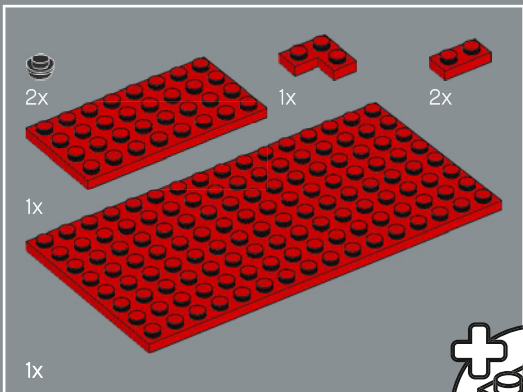

143

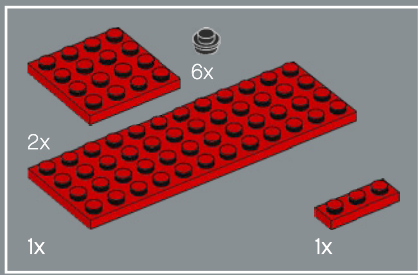

144

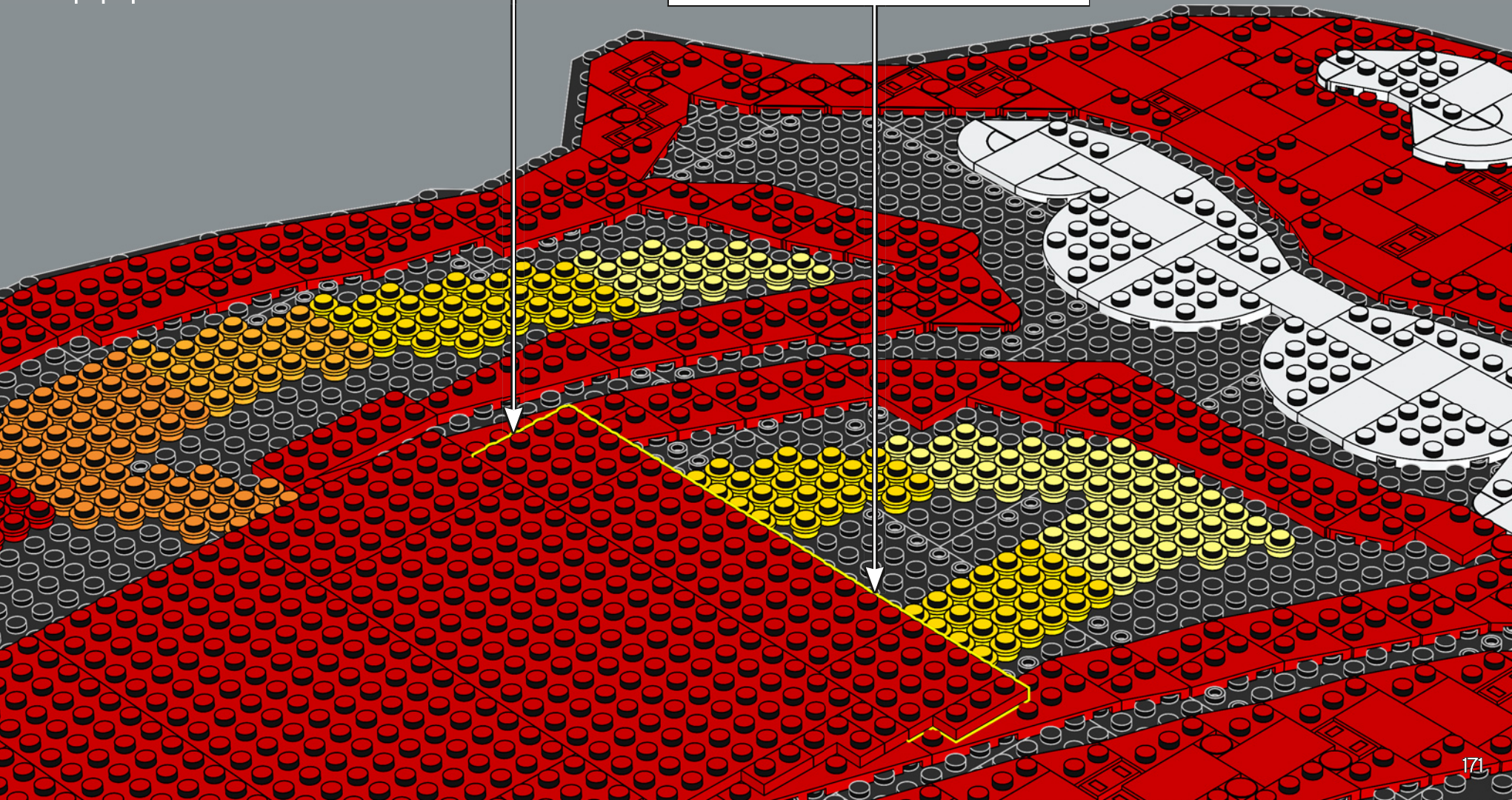
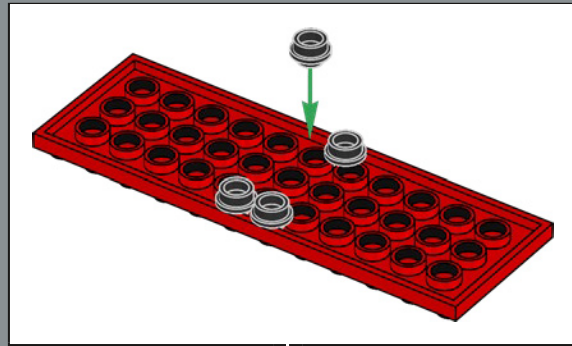
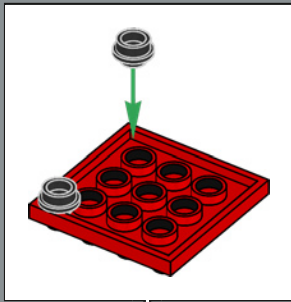

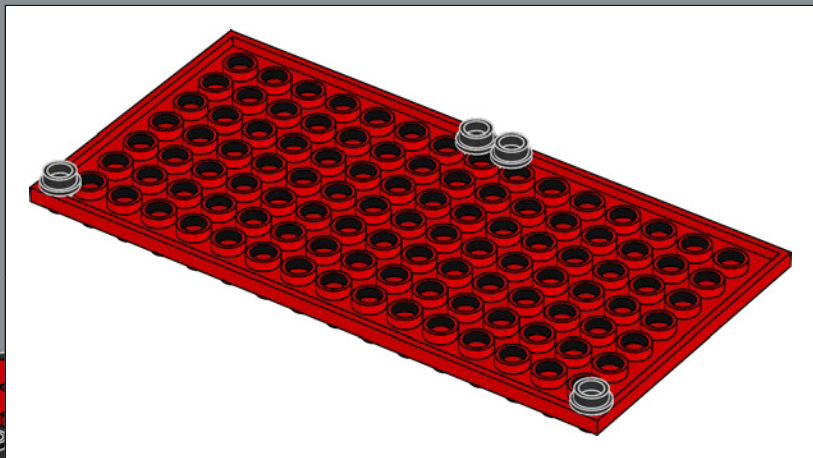
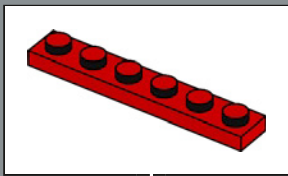
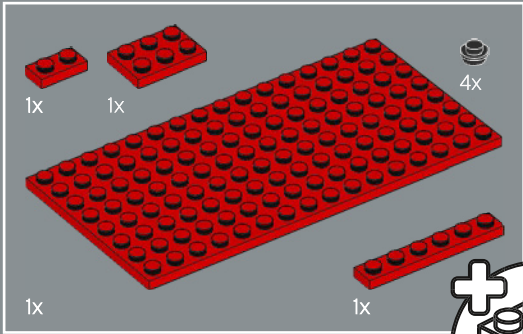

145

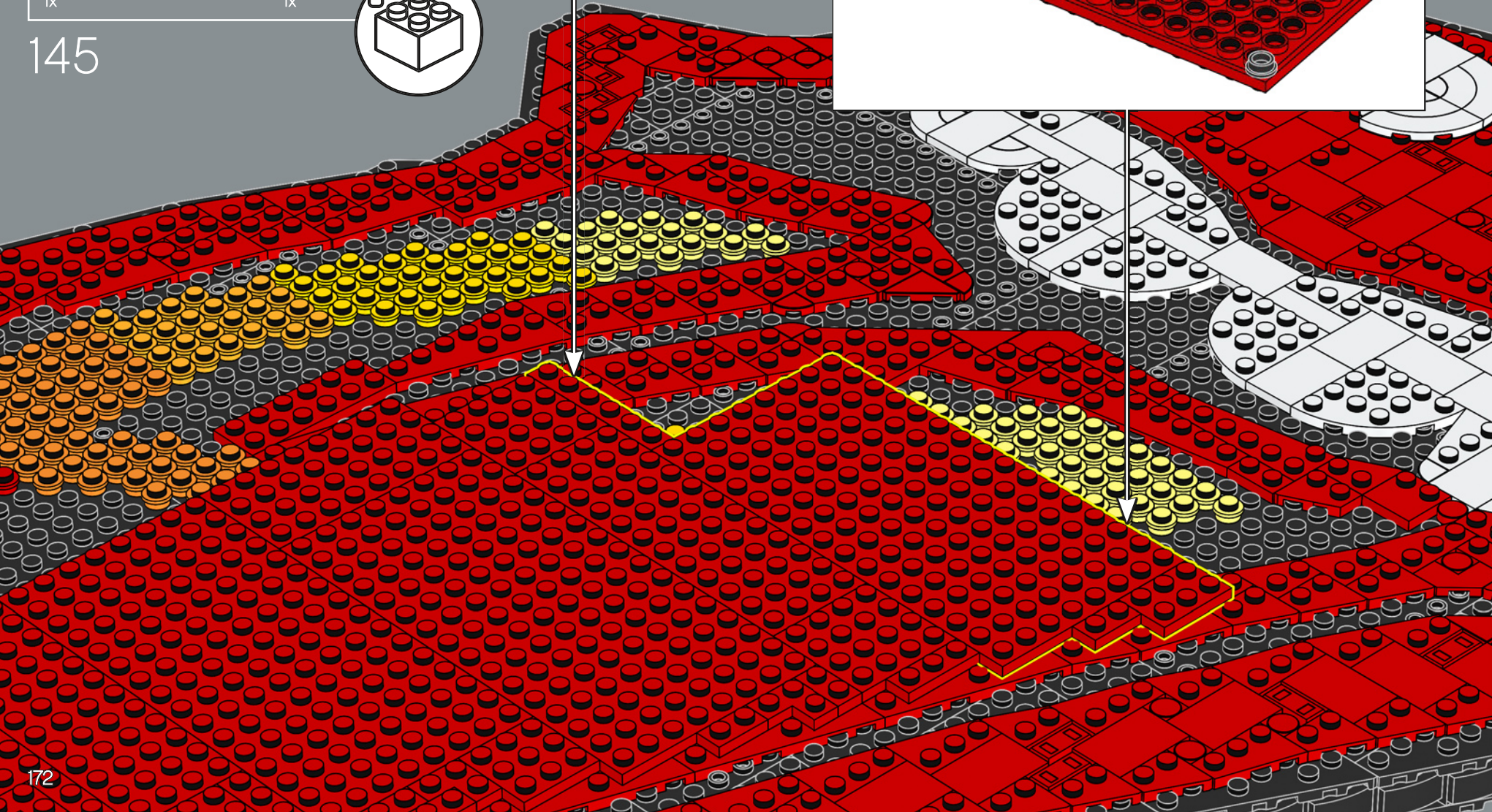

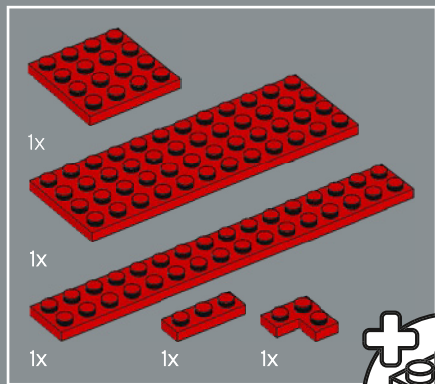

146

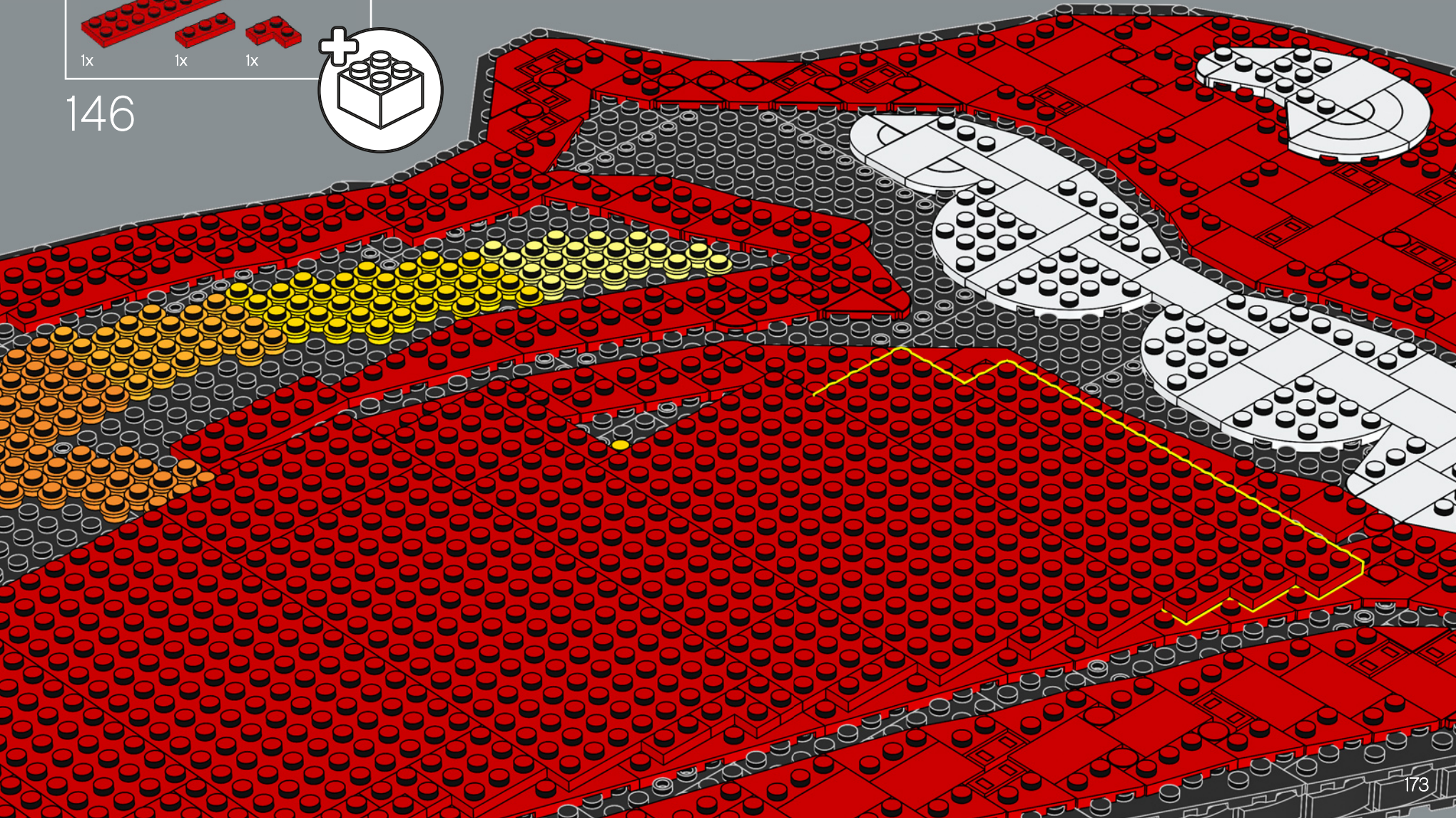
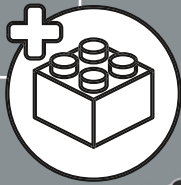

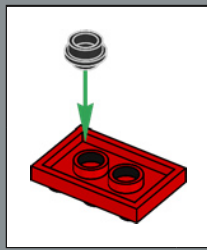
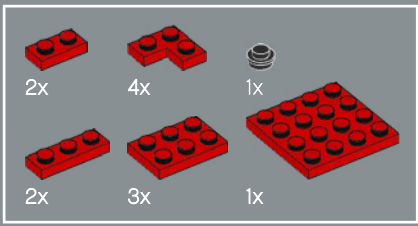

147

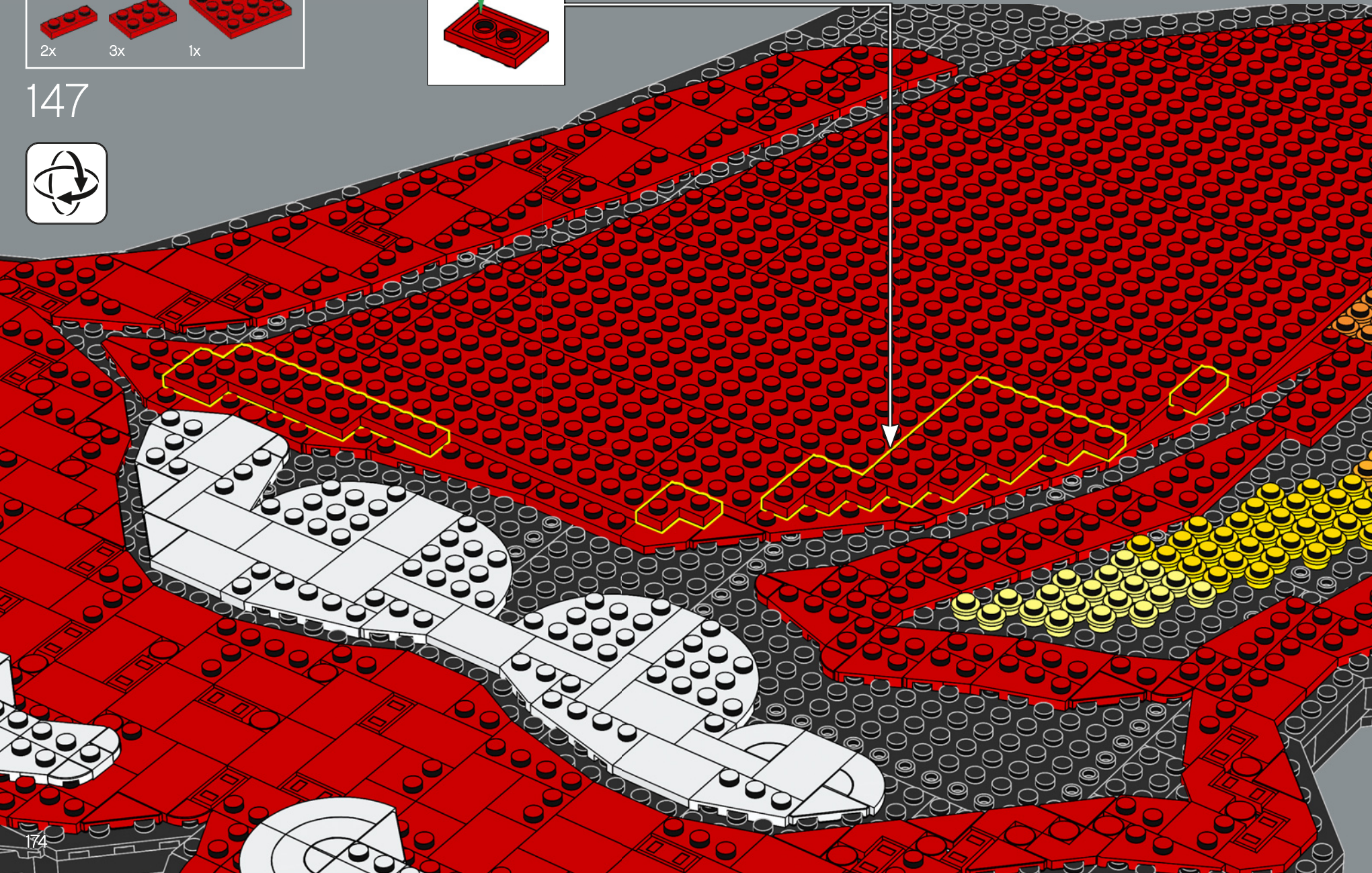

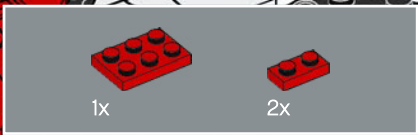

148

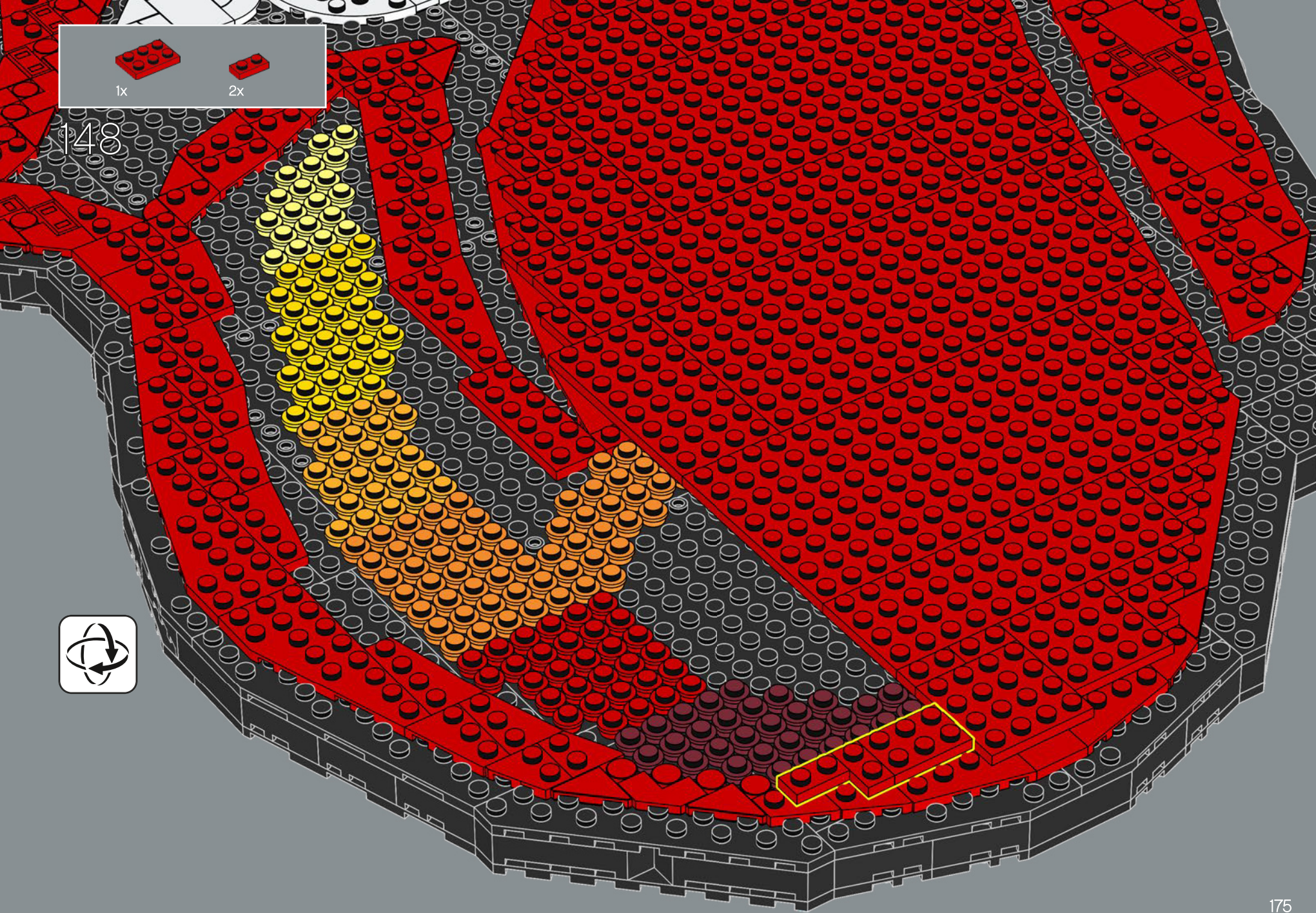

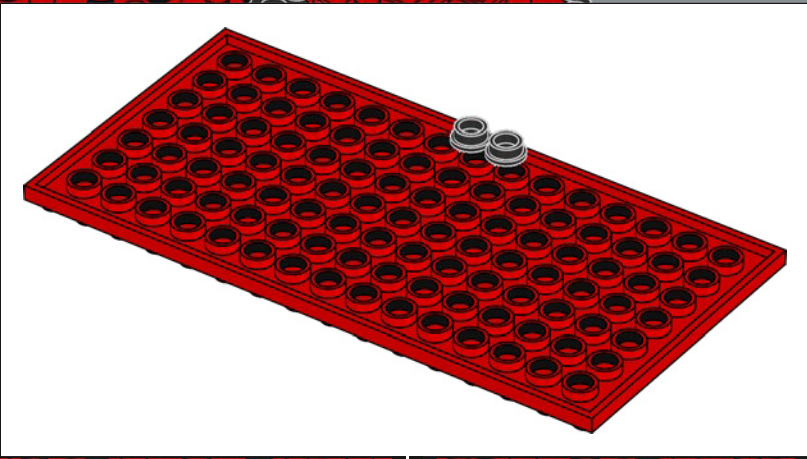
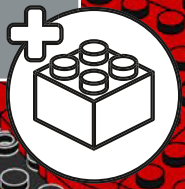
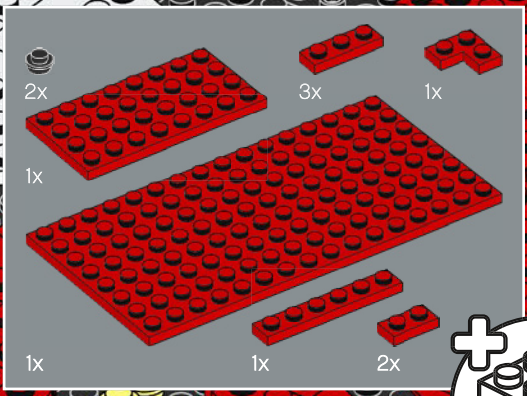

149

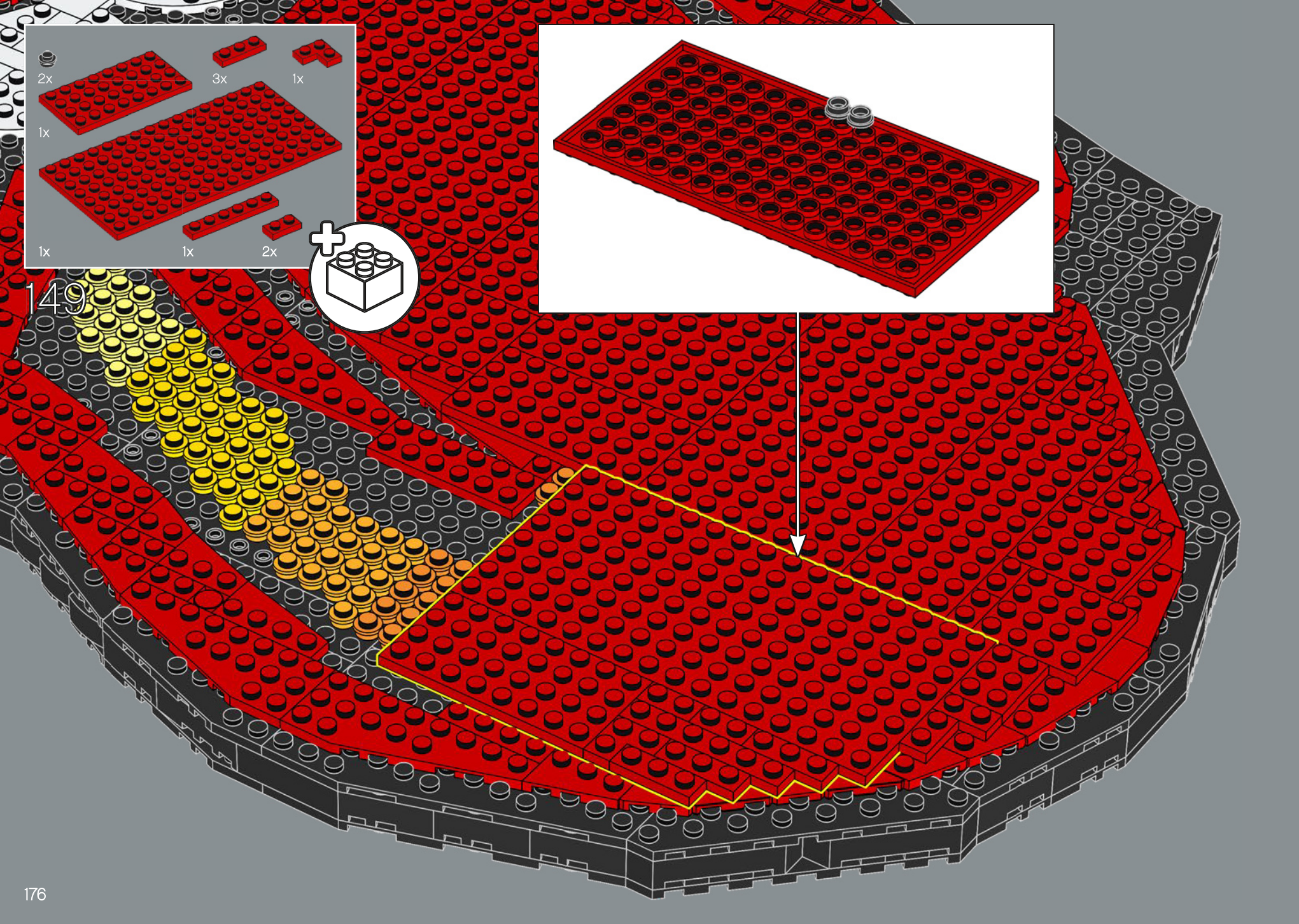

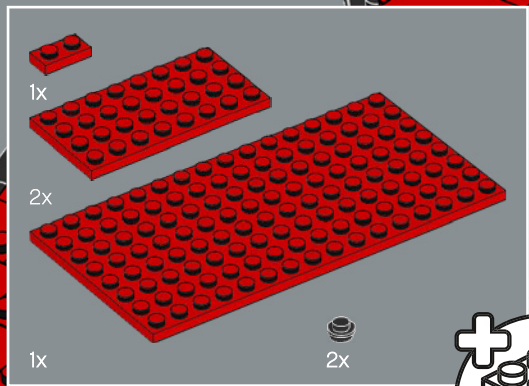

150



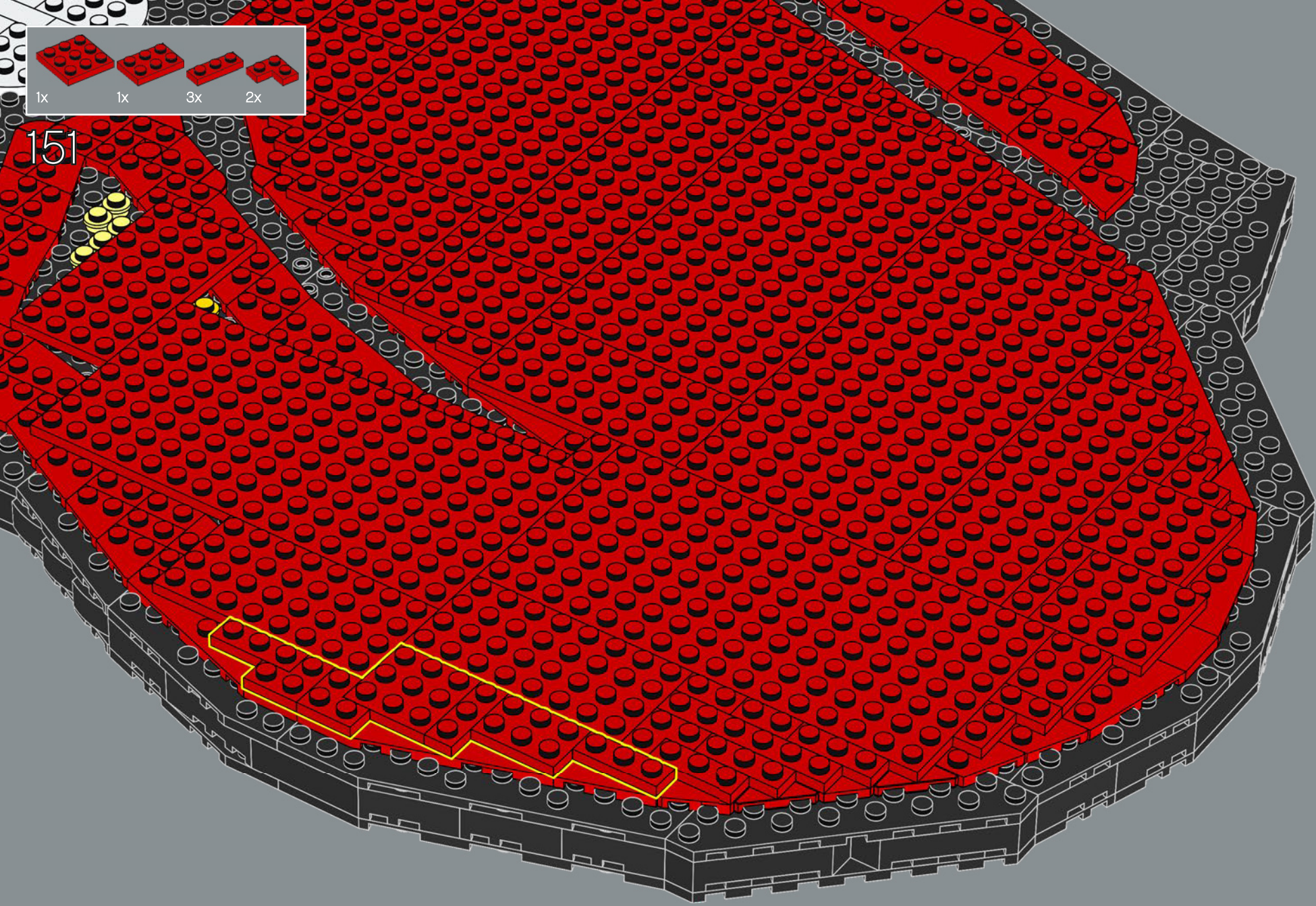

151

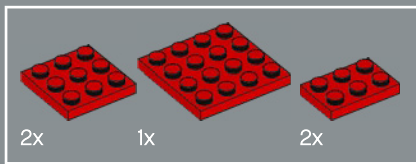

152

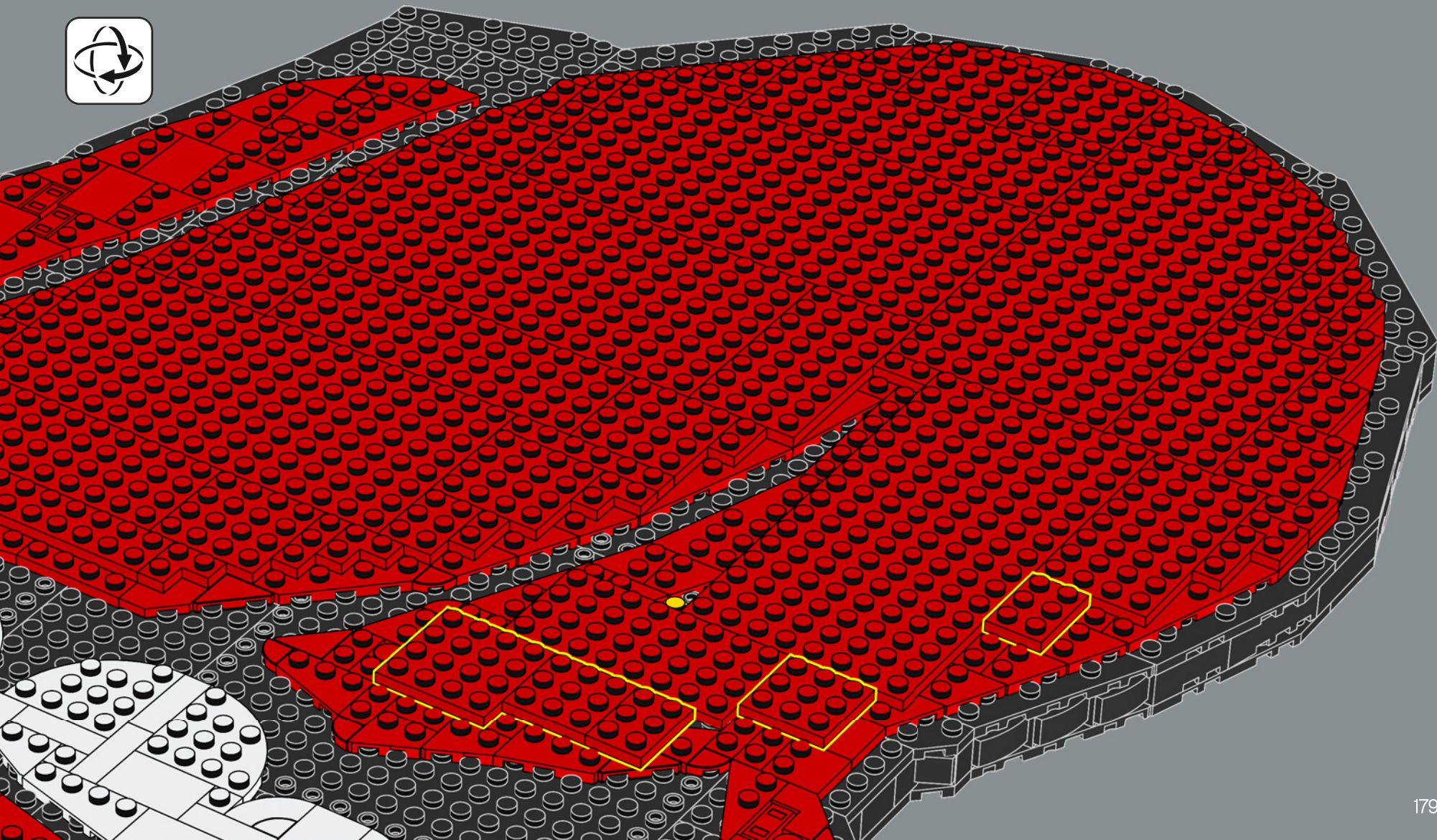



153

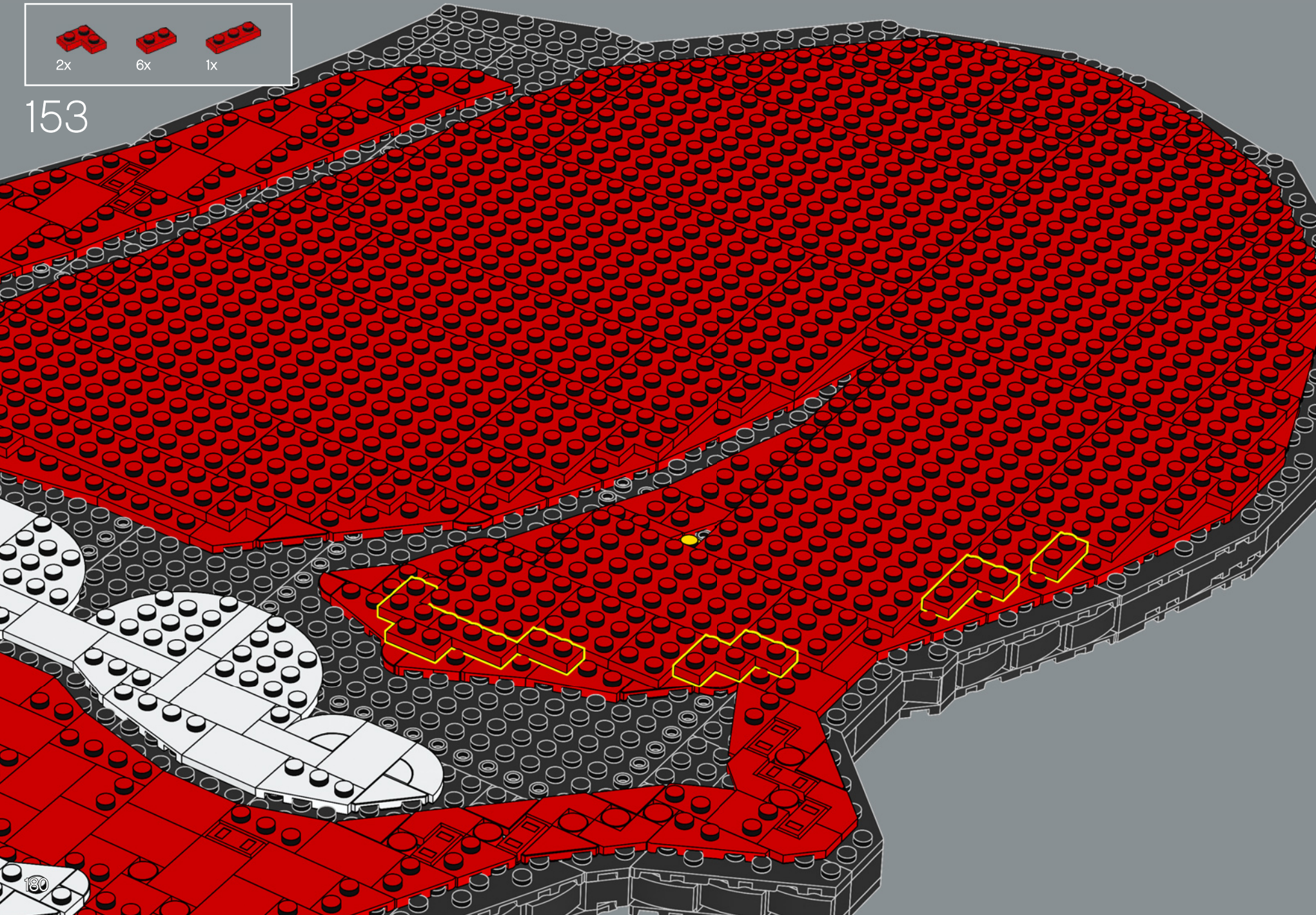

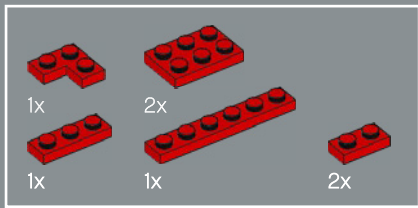

154

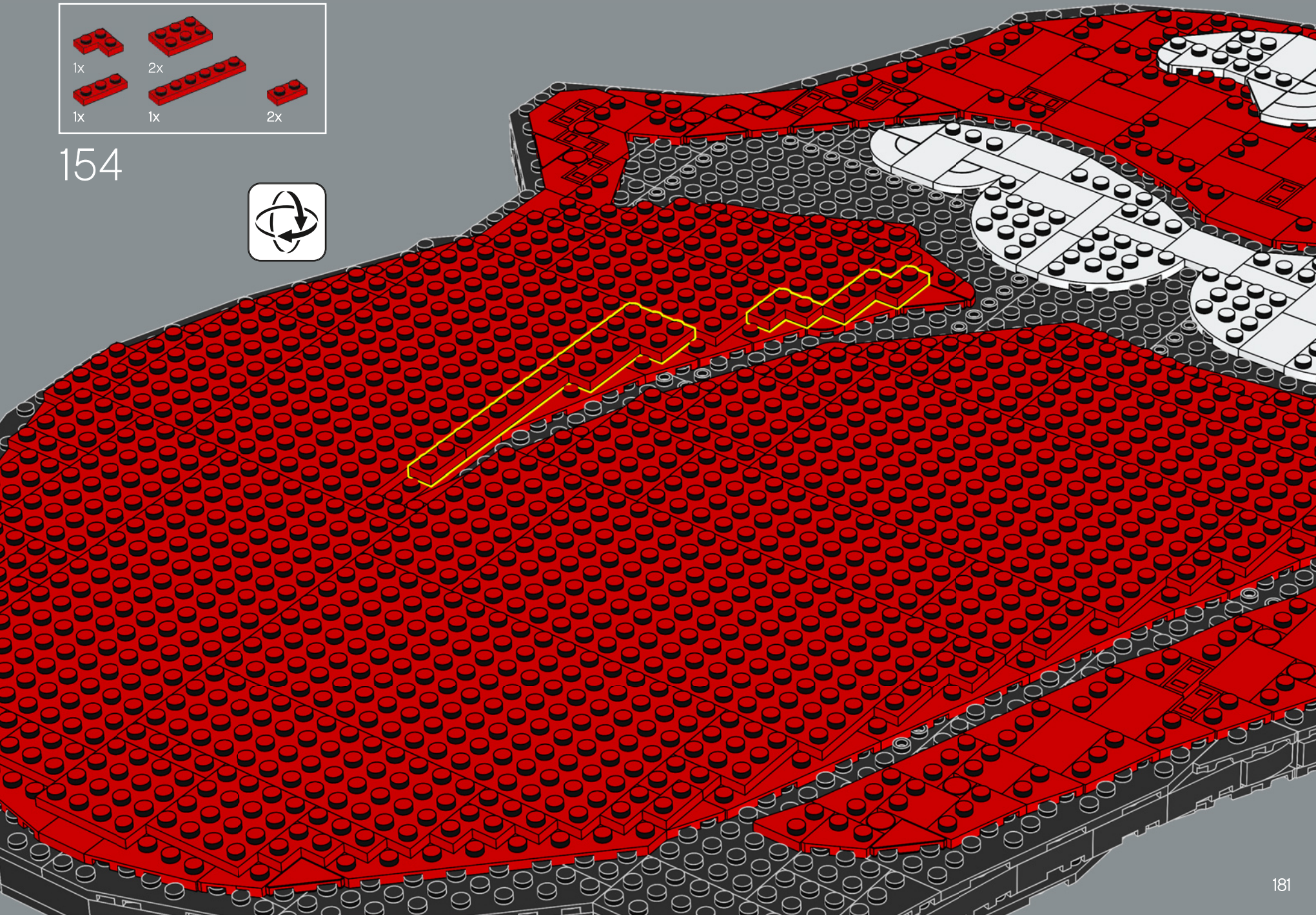



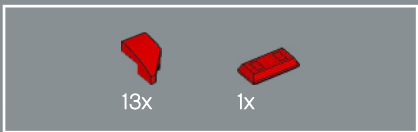

155

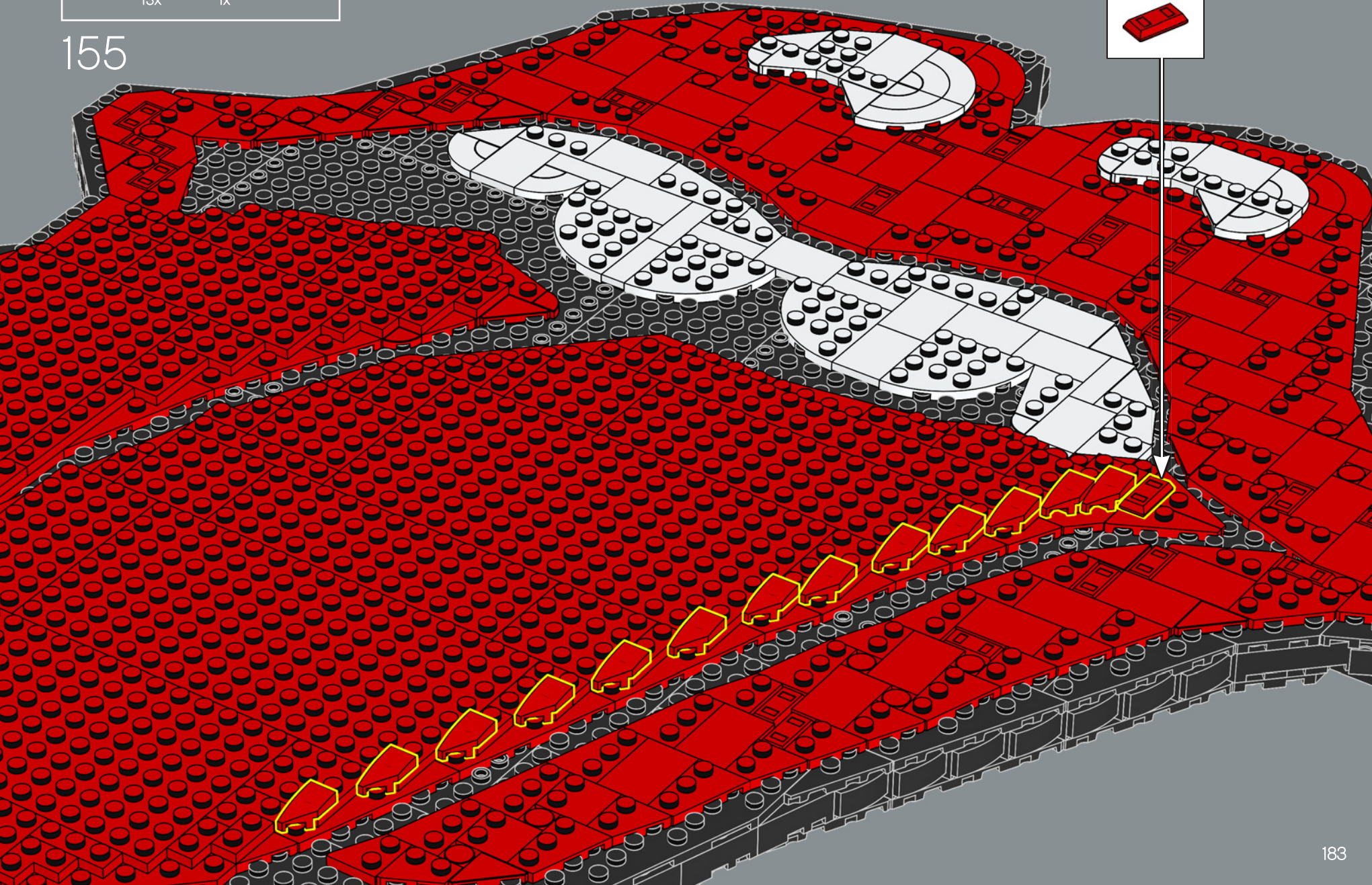
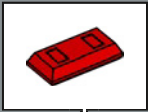

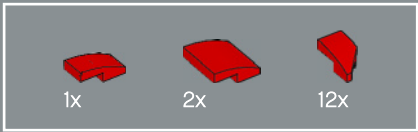

156

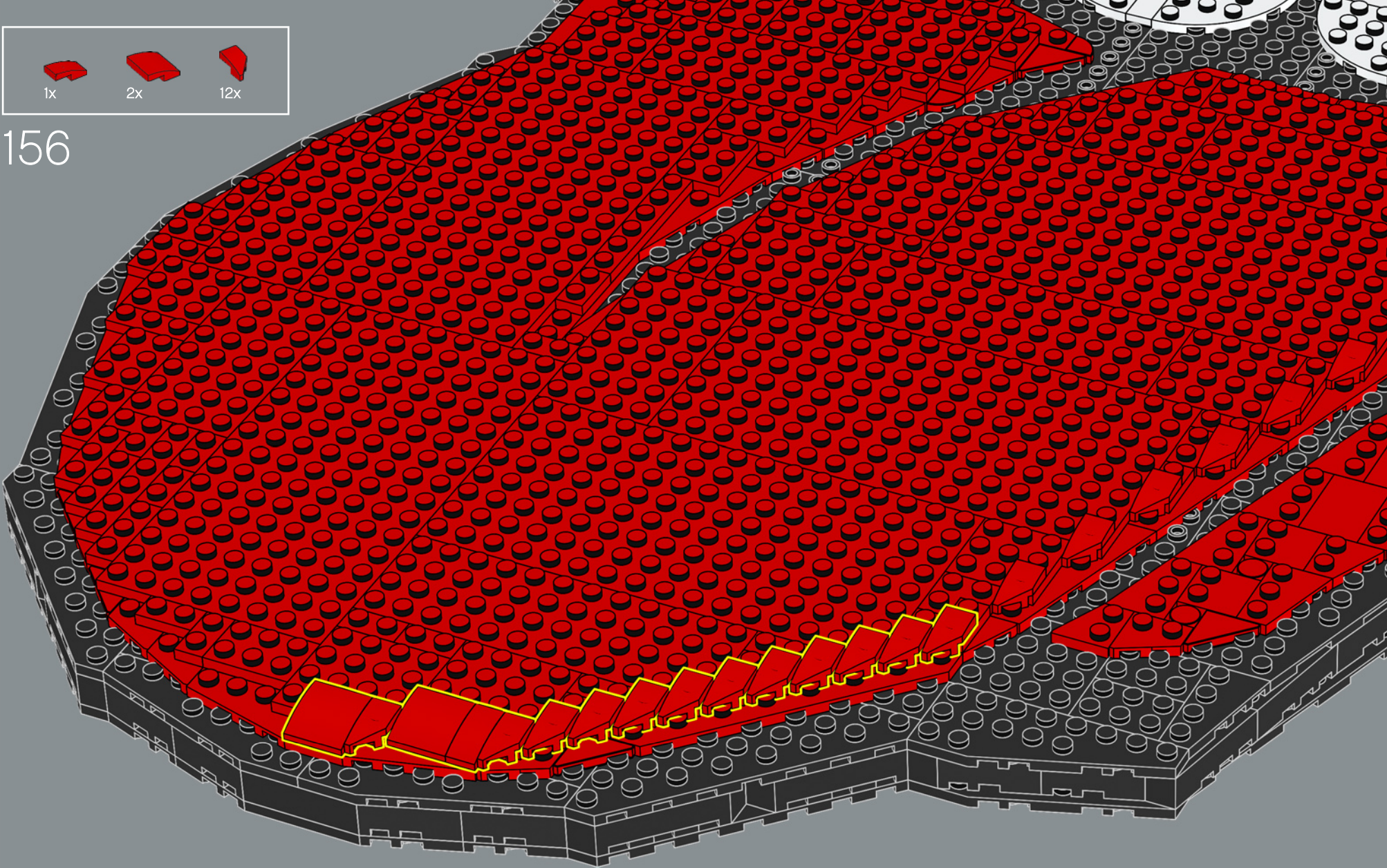

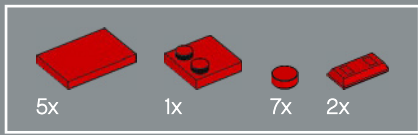

157

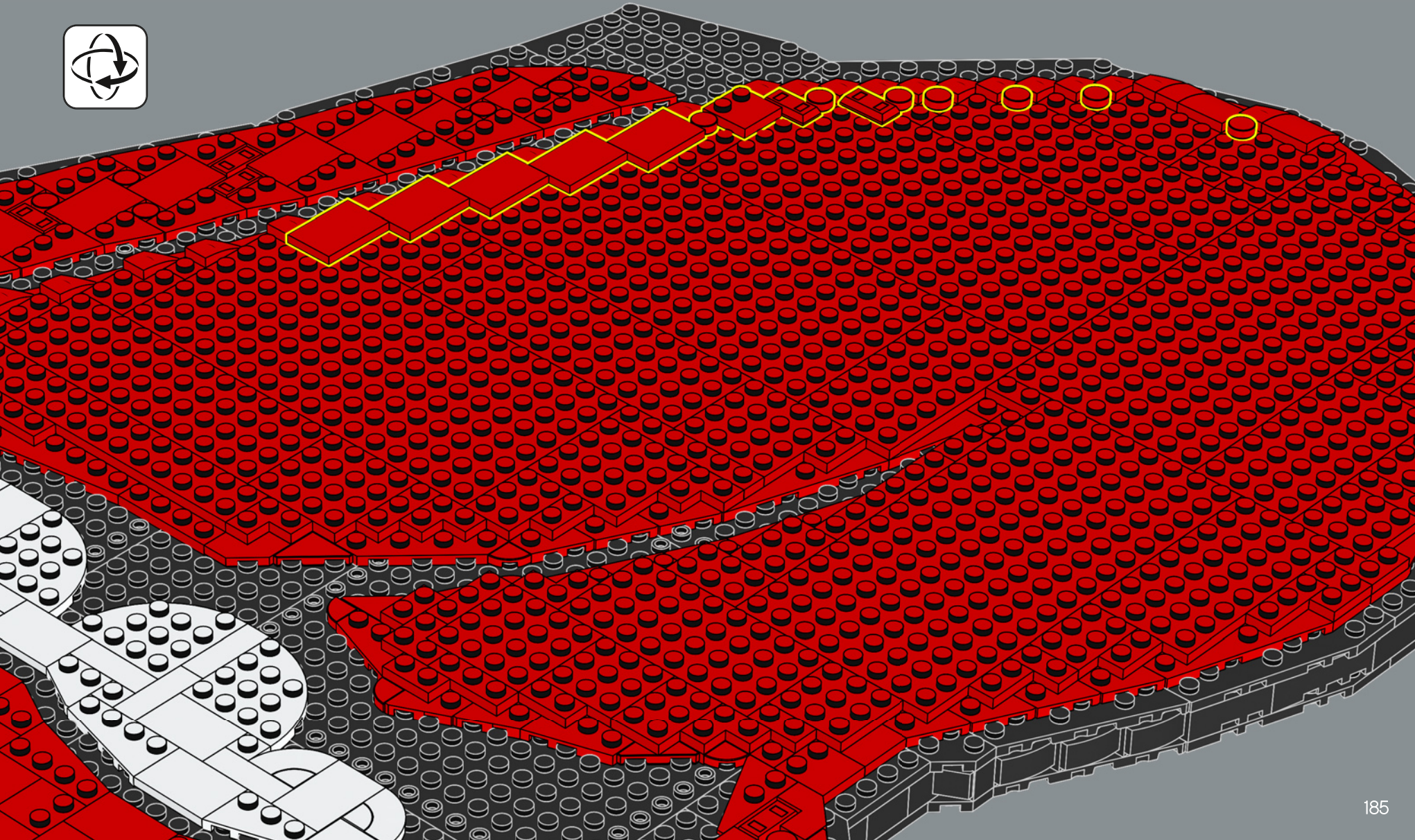

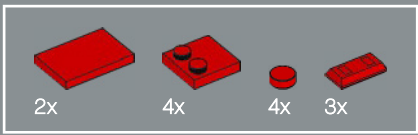

158

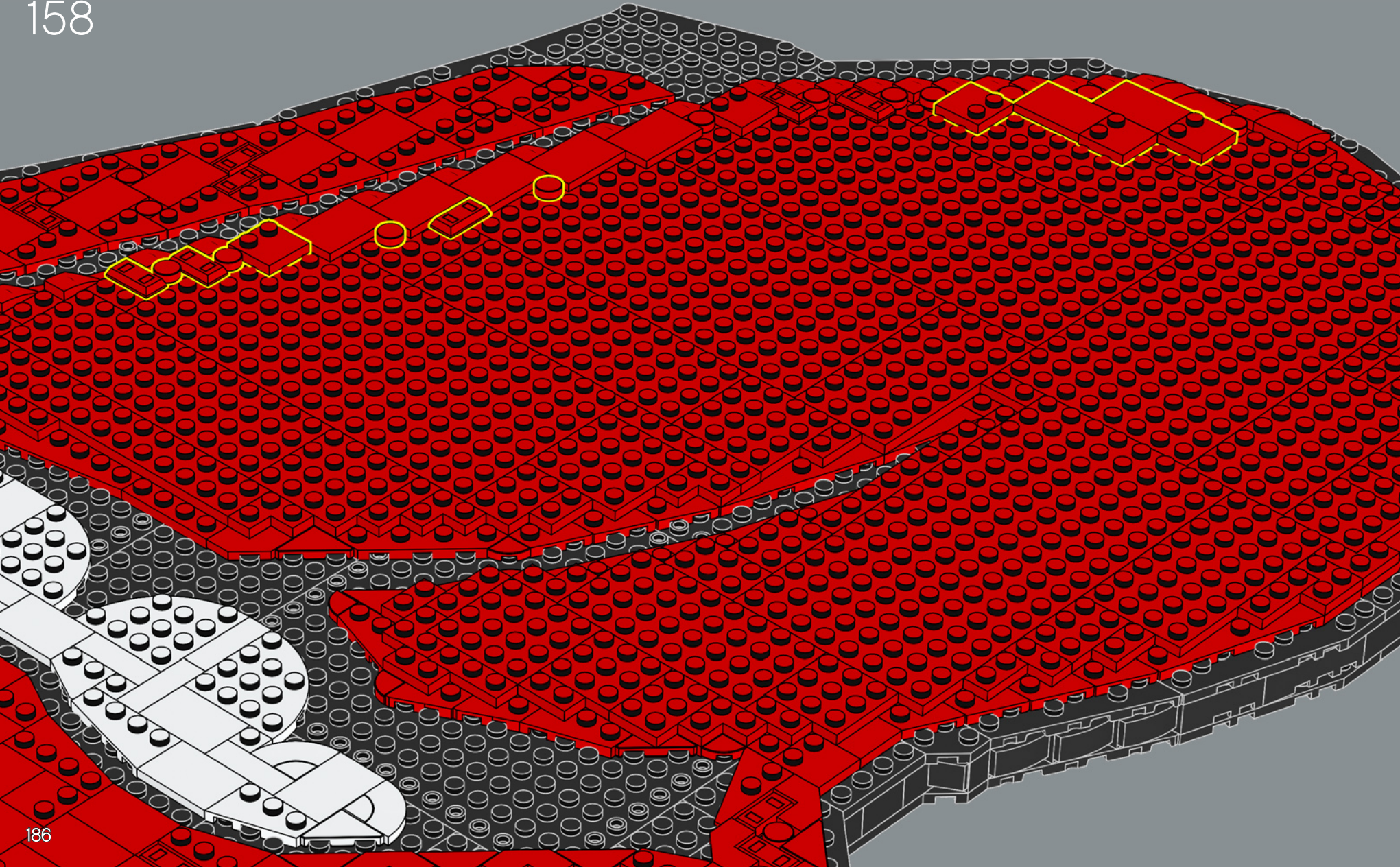

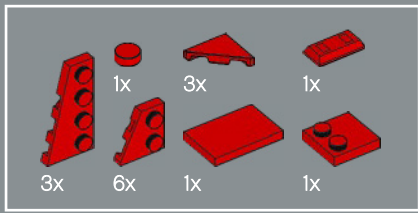

159

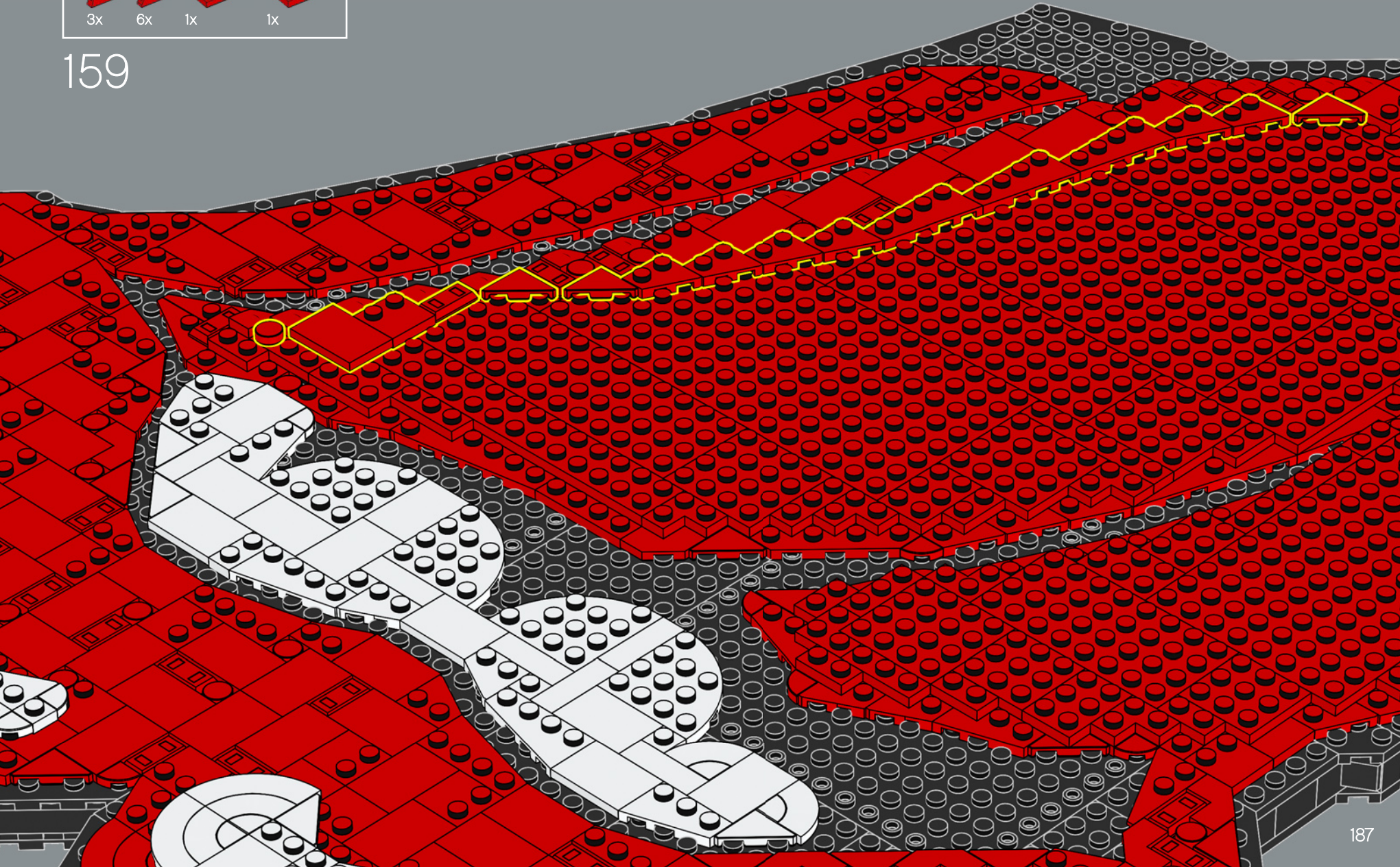

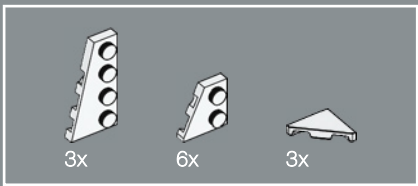

160

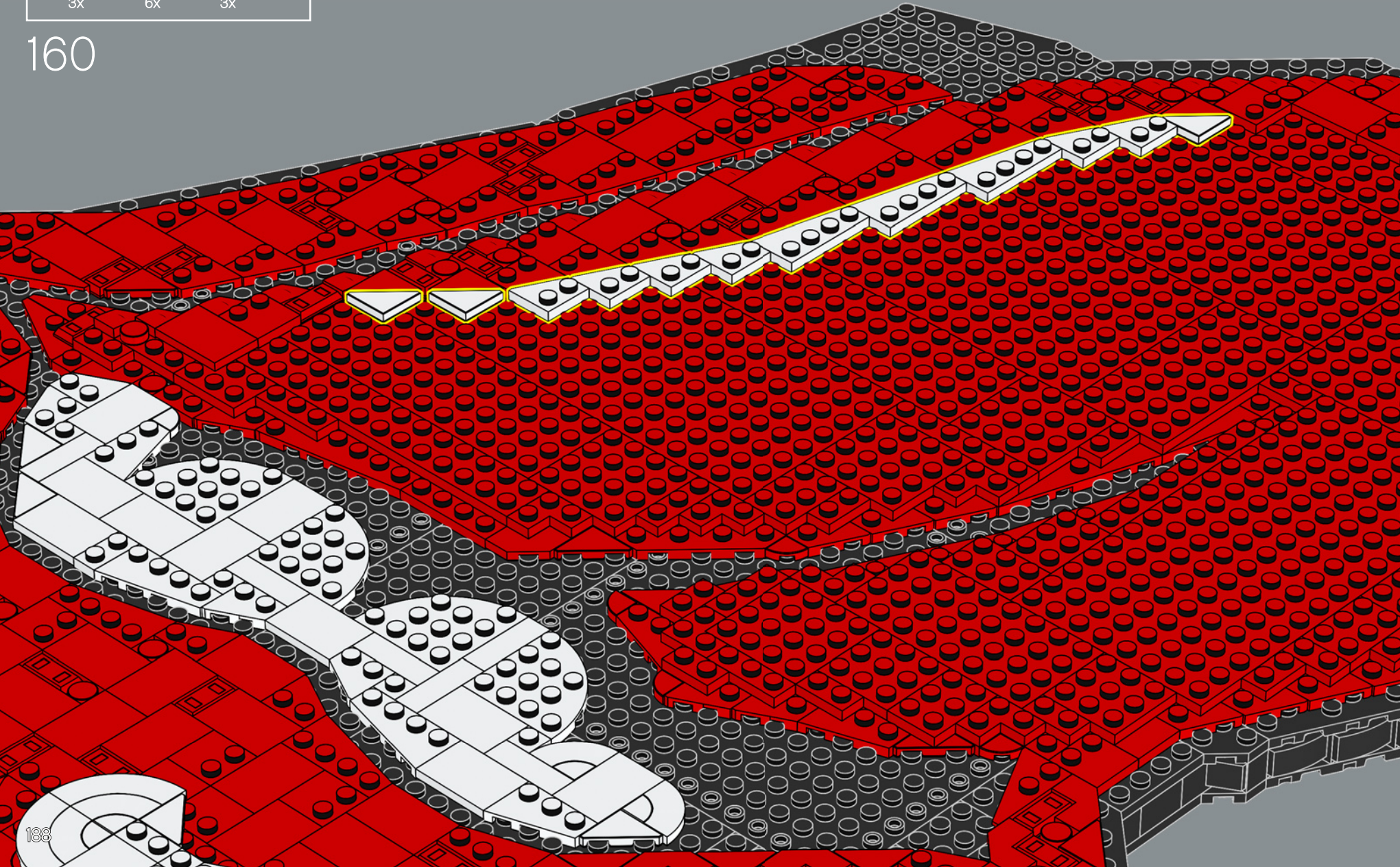

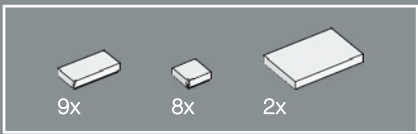

161

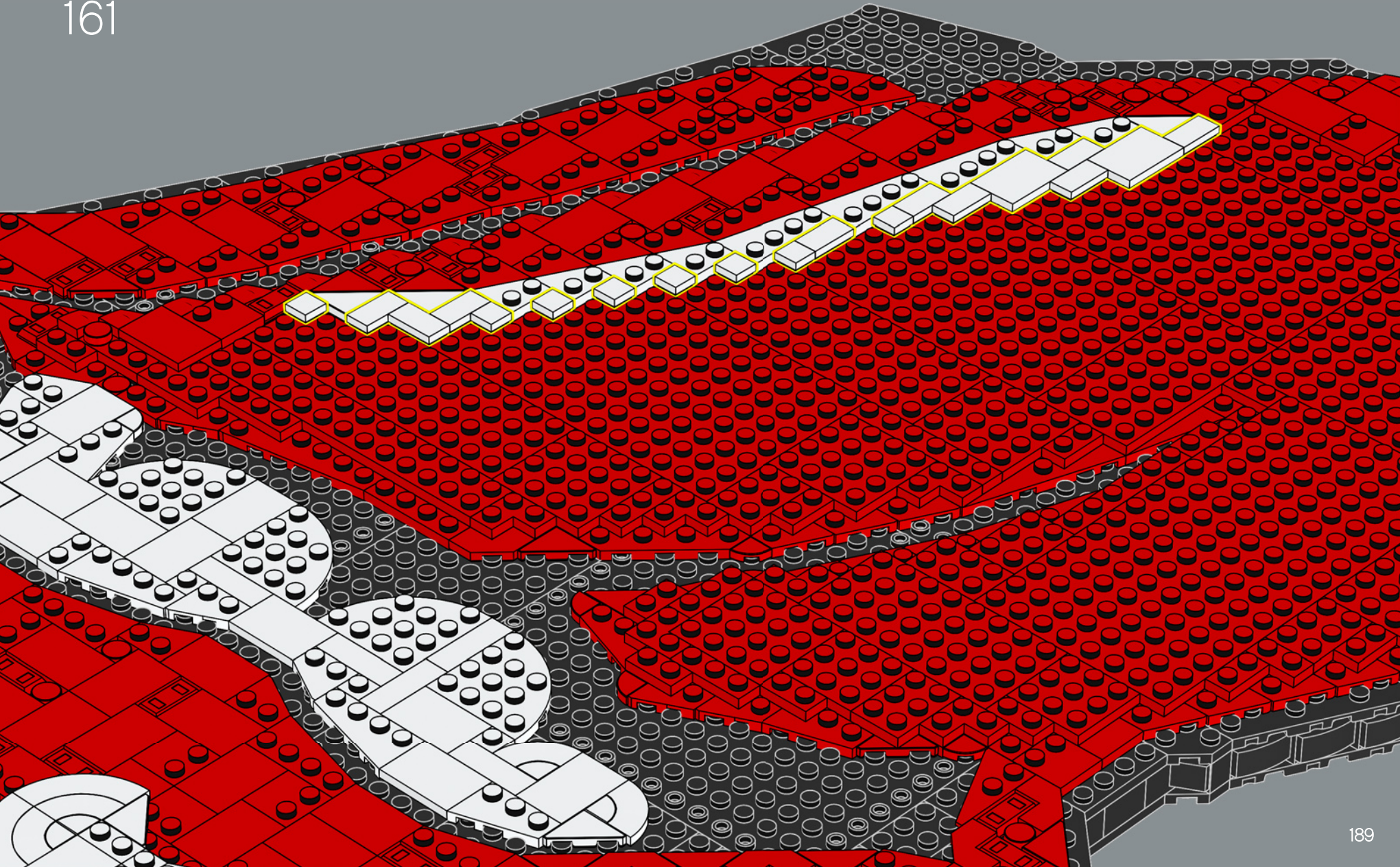

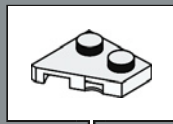
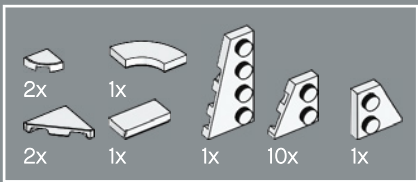

162

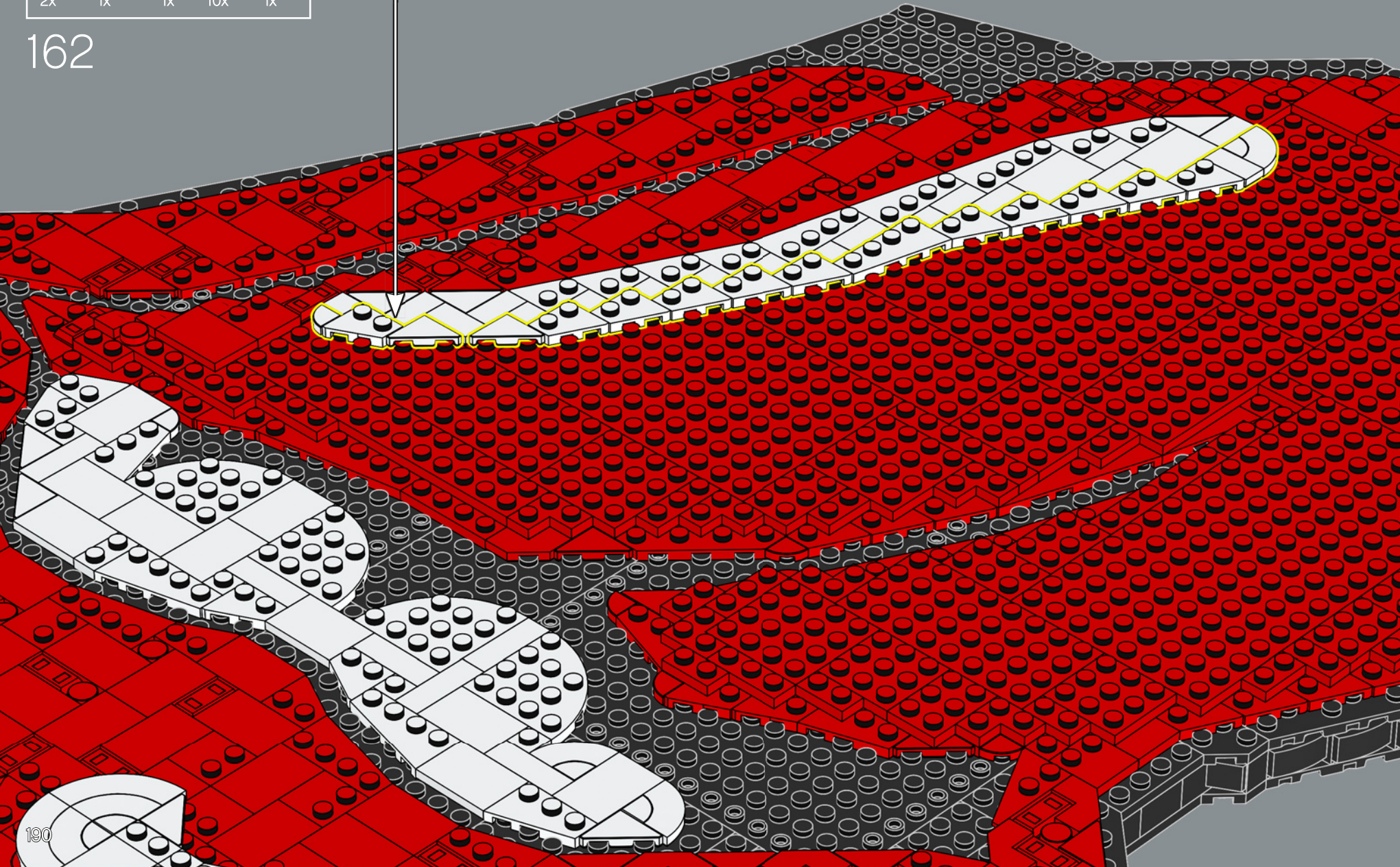

190

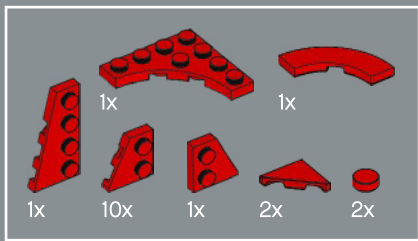

163

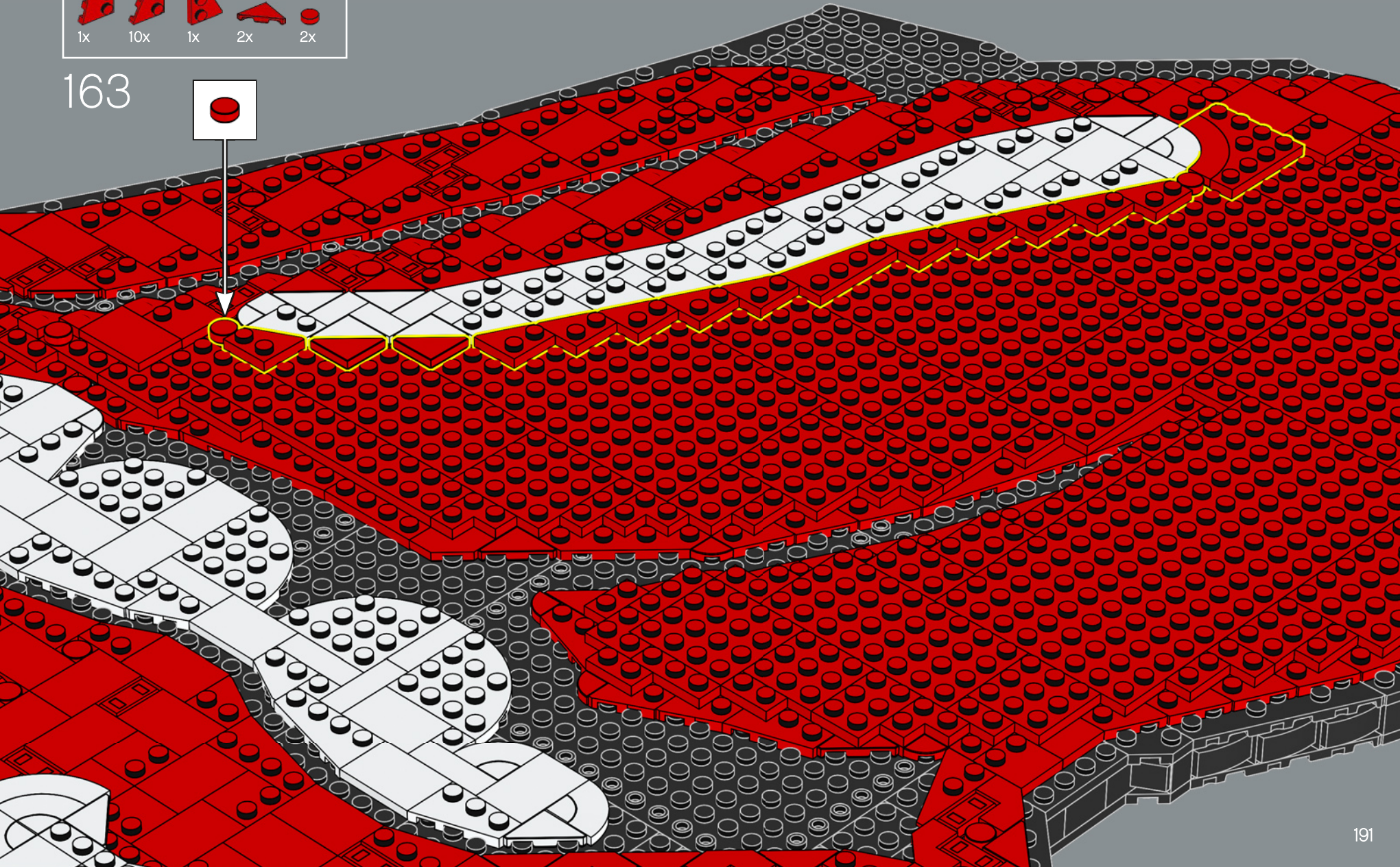

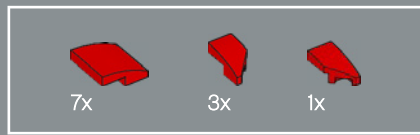

164

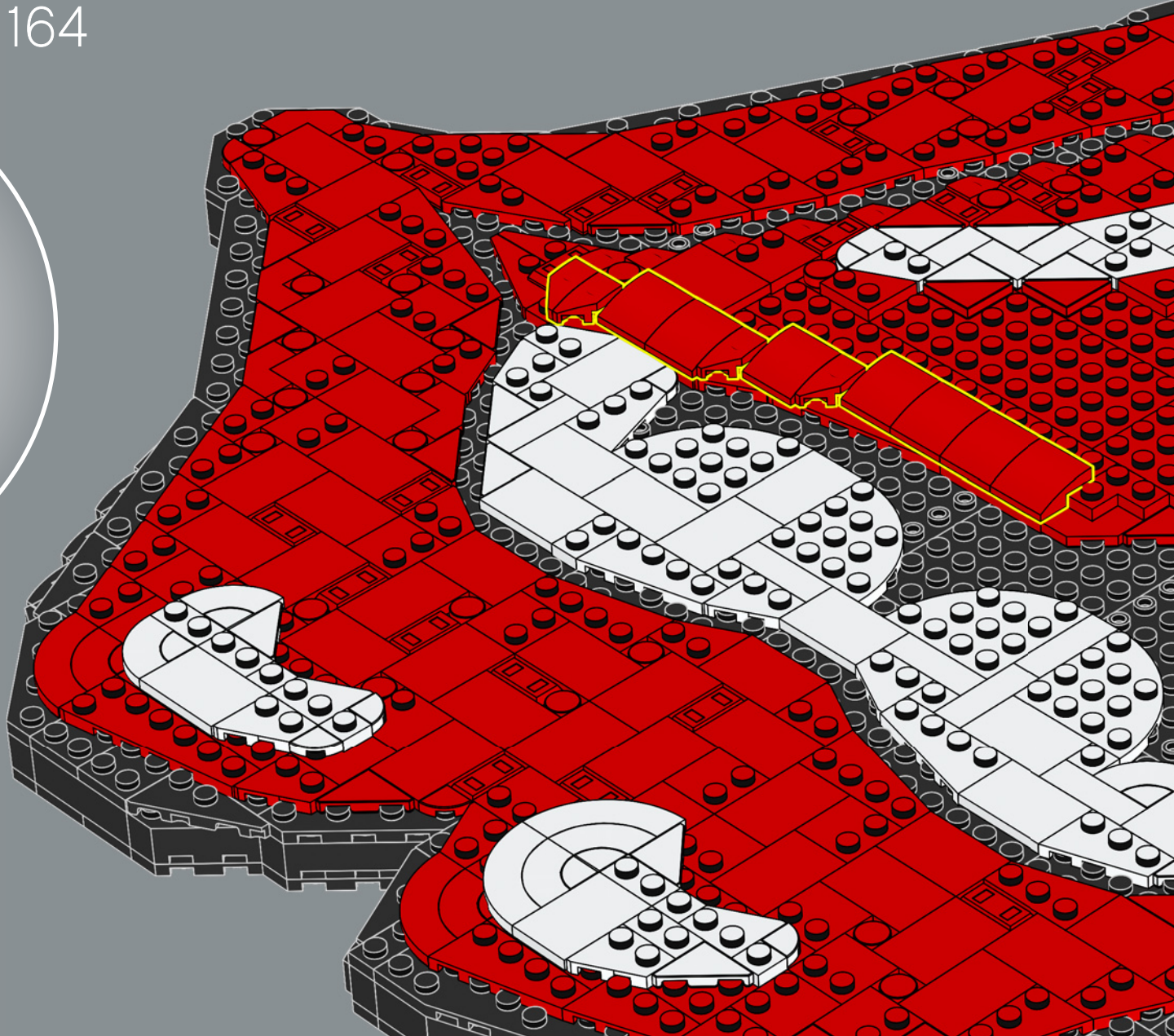



165

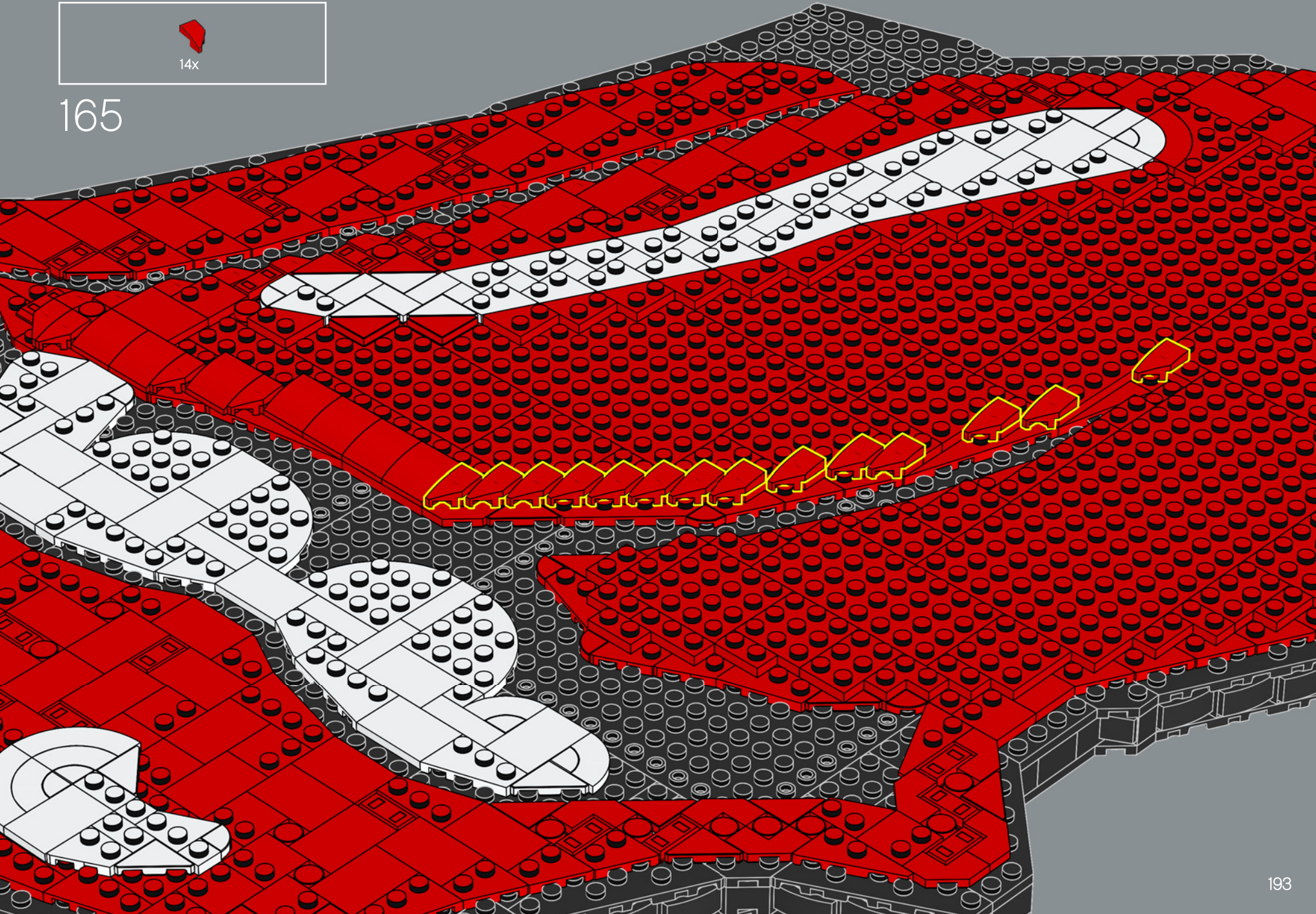

3x 1x 12x



166

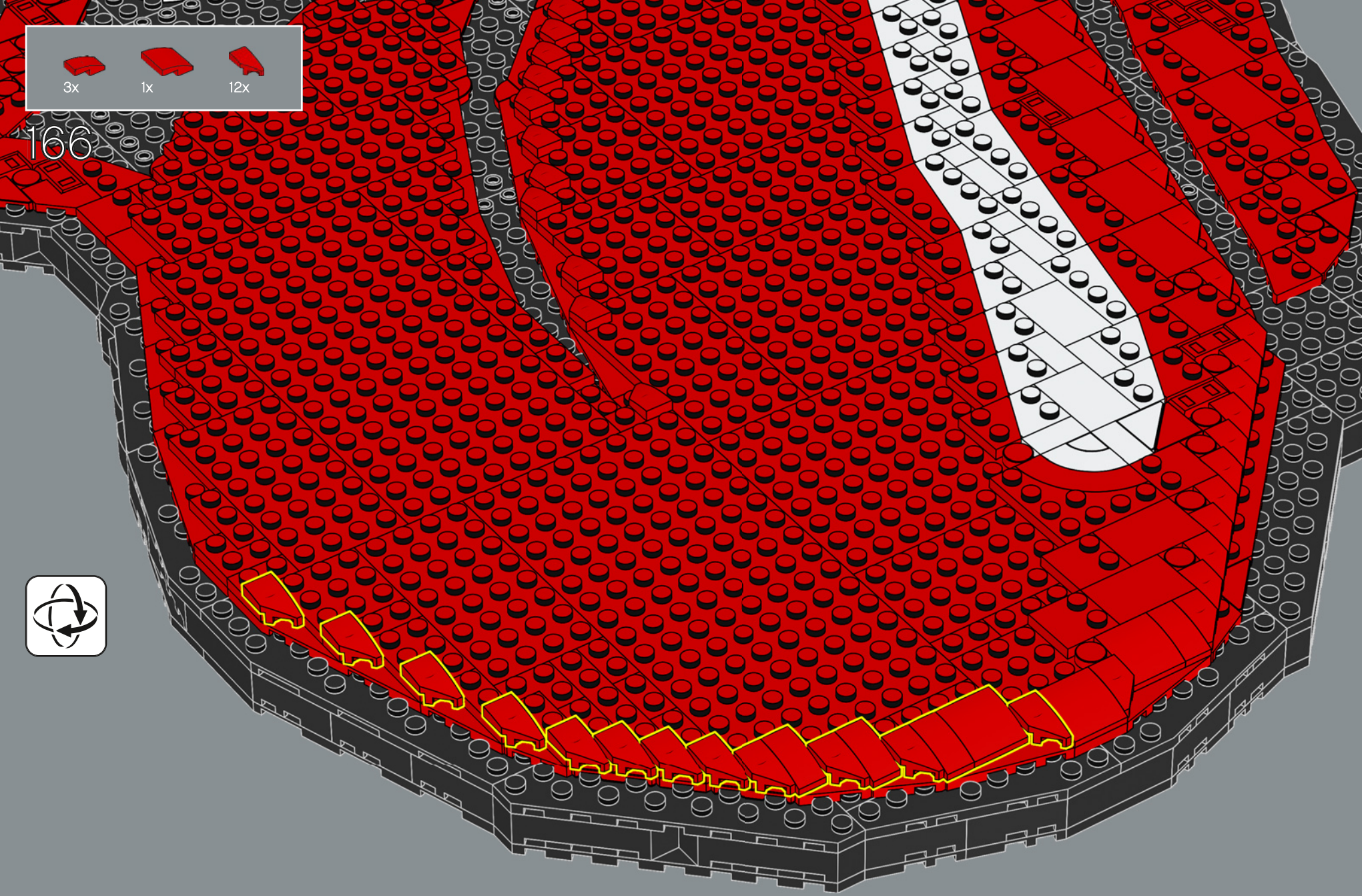

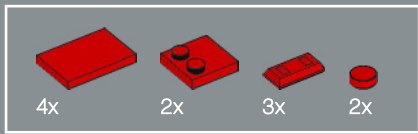

167

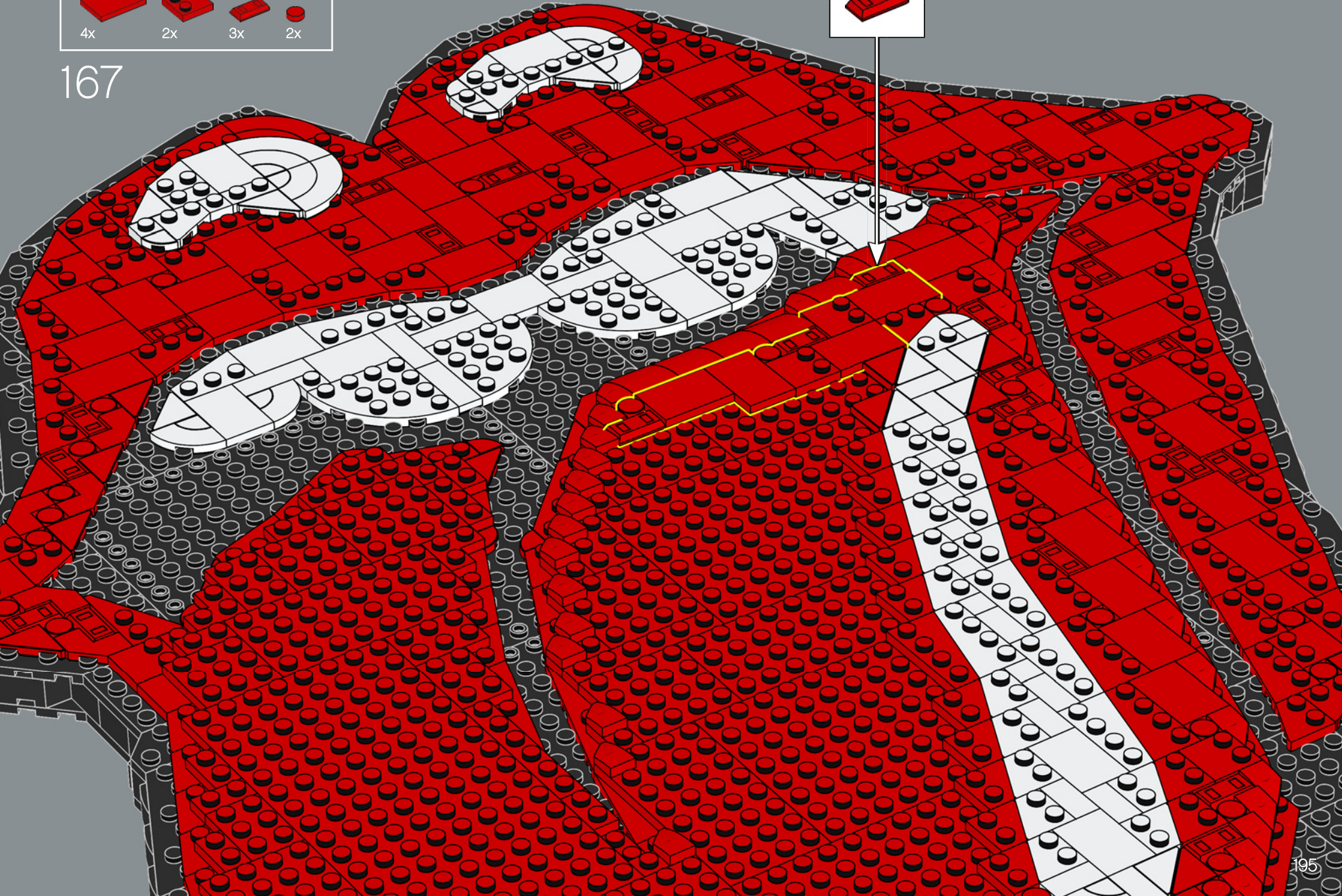

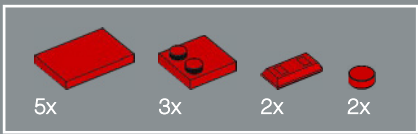

168

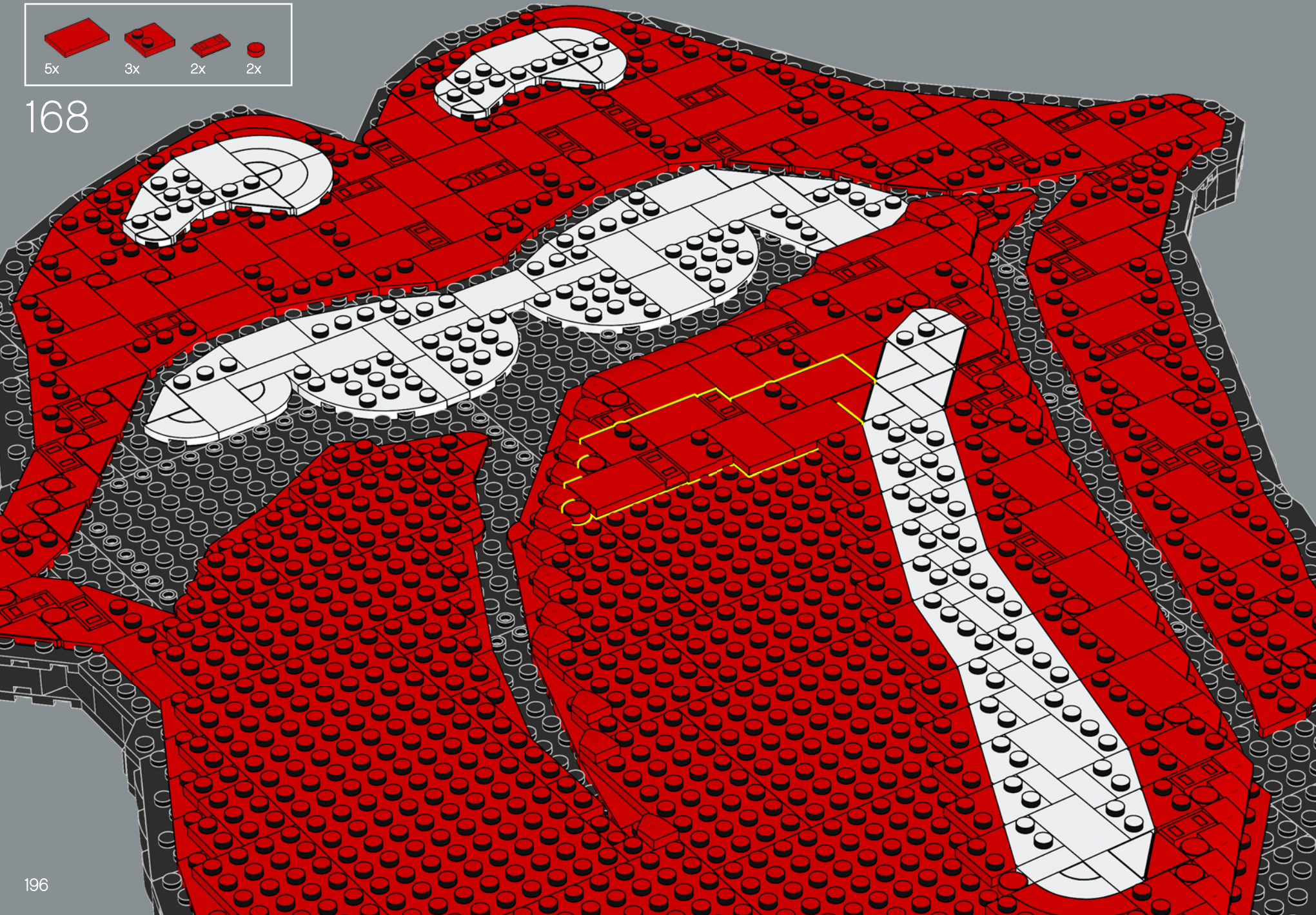

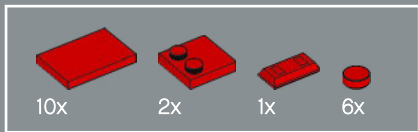

169

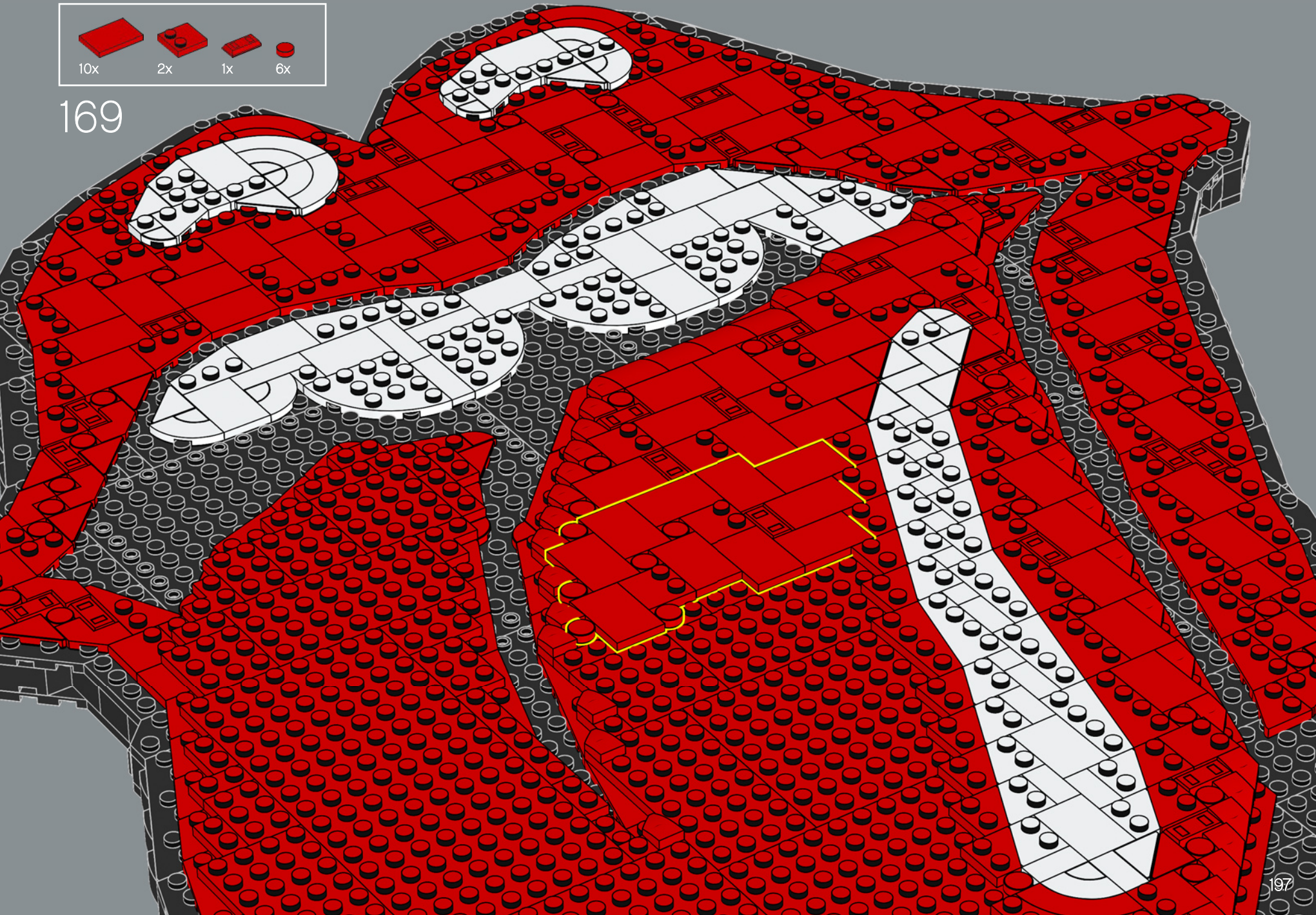

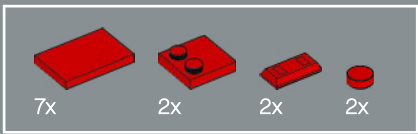

170

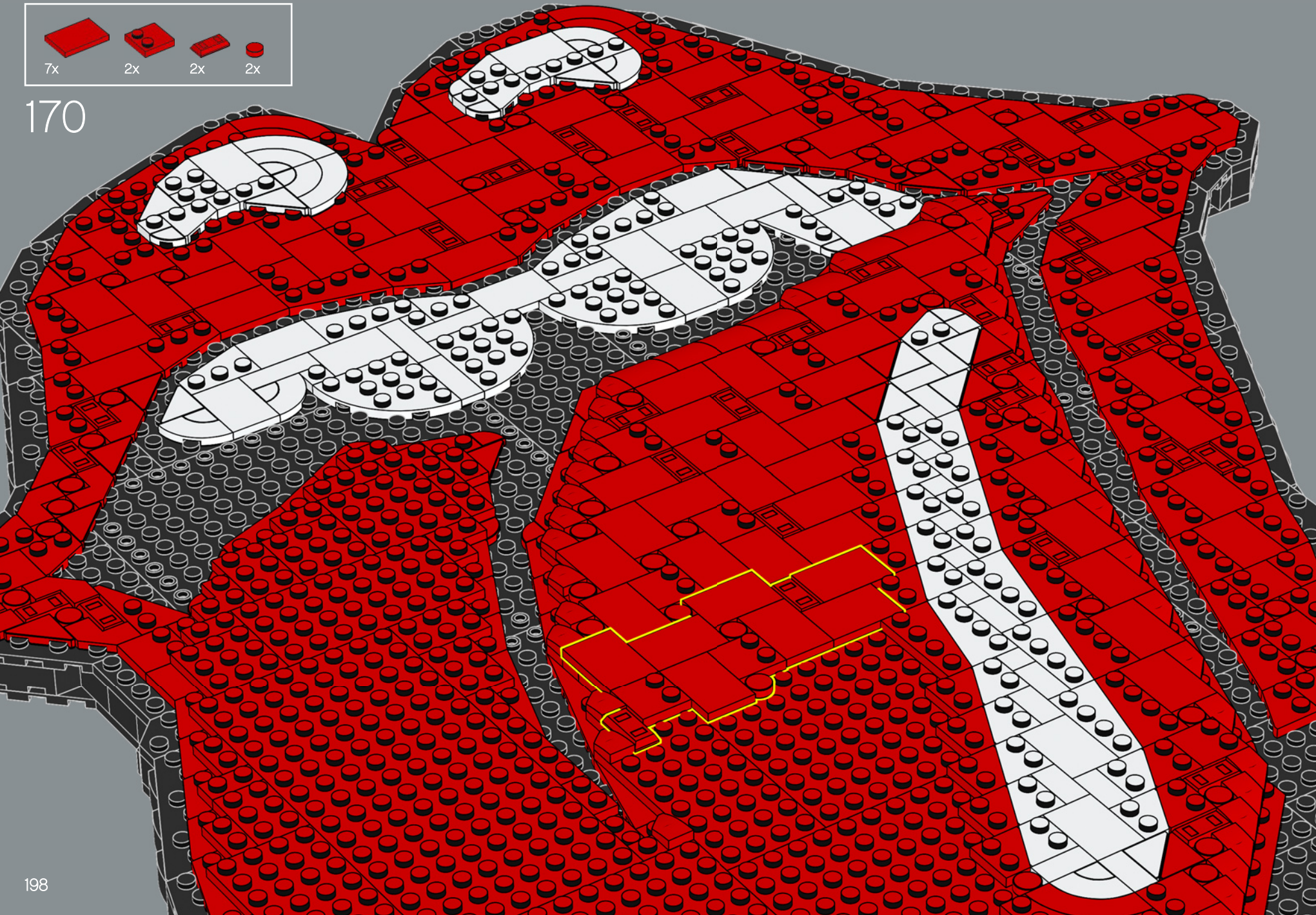

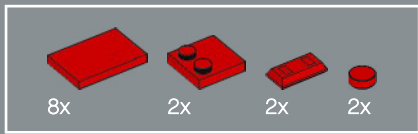

171

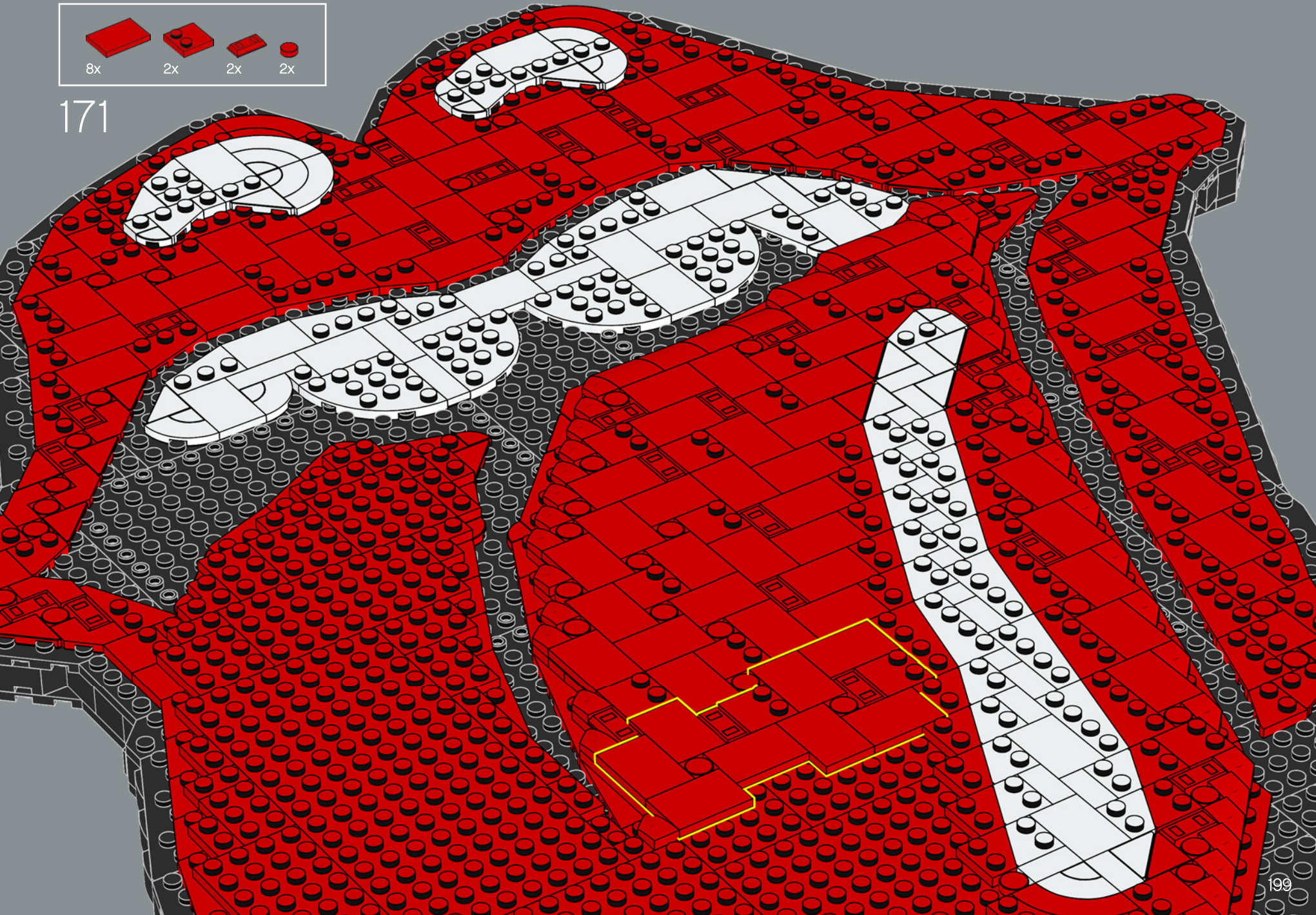

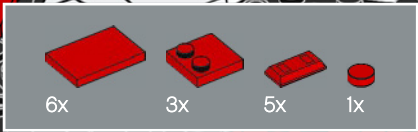

172

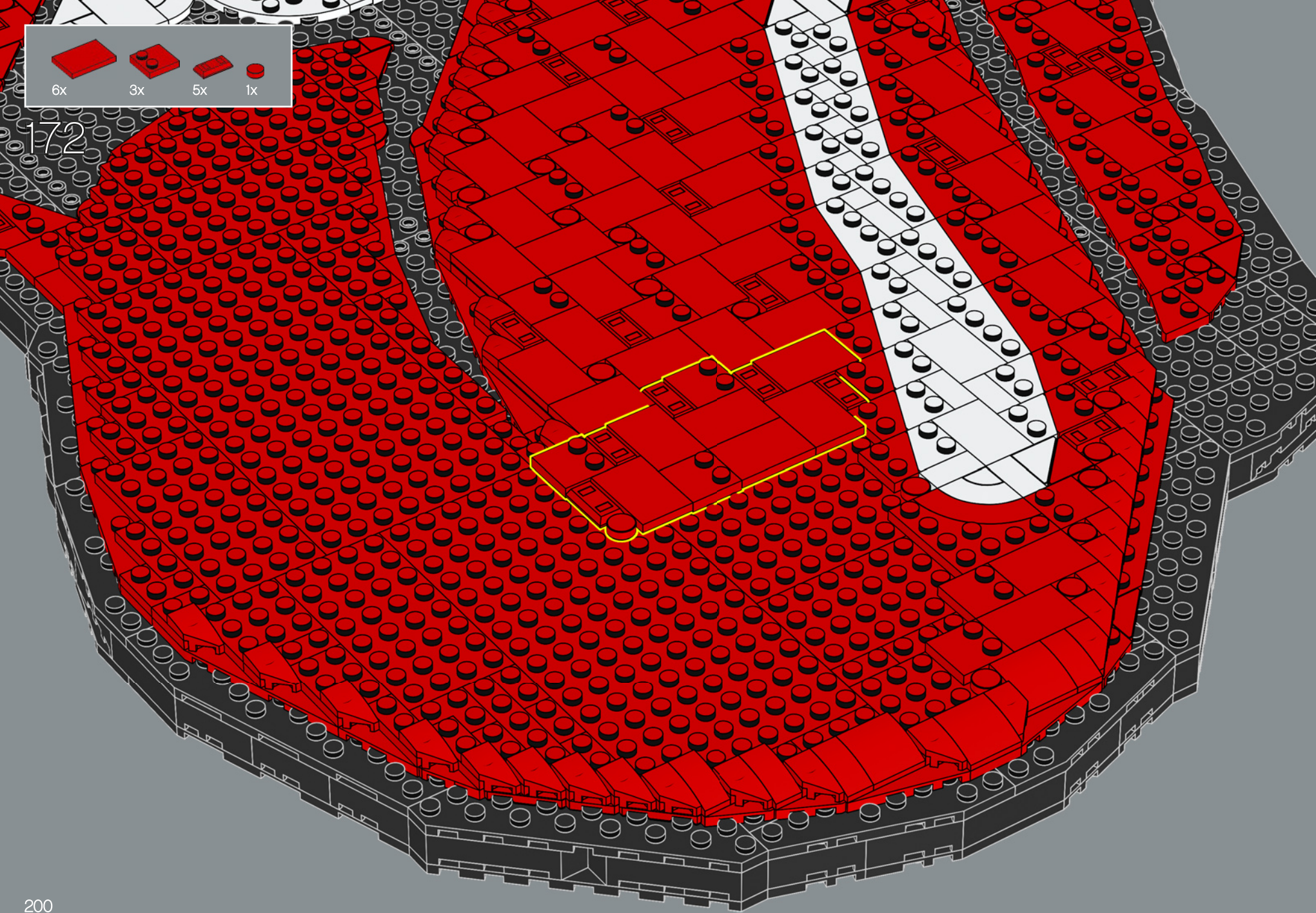

5x 6x 2x 1x

173

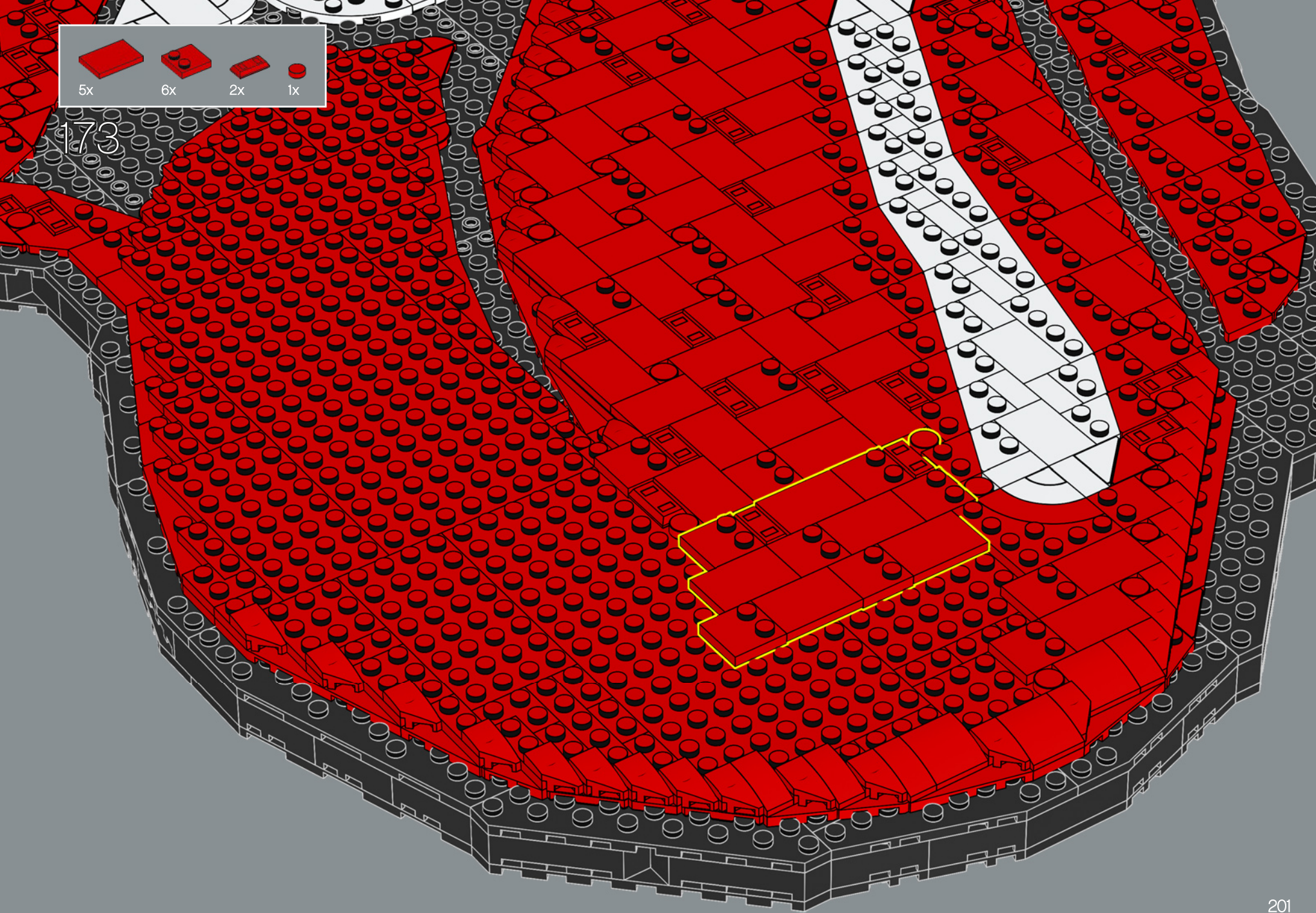

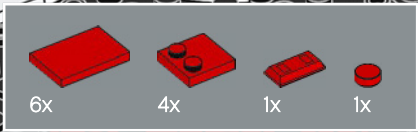

174

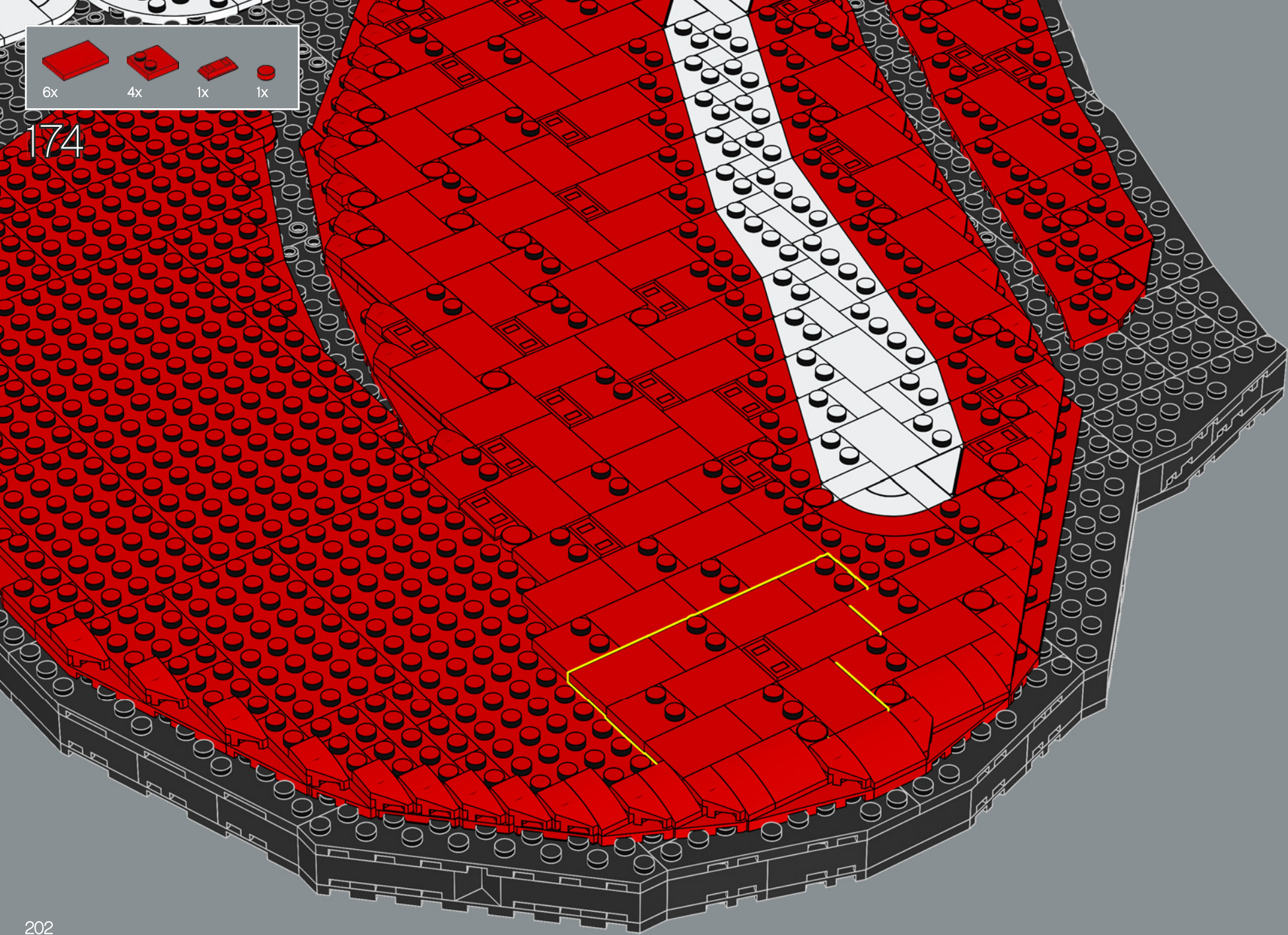

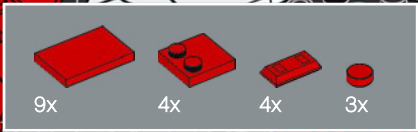

175

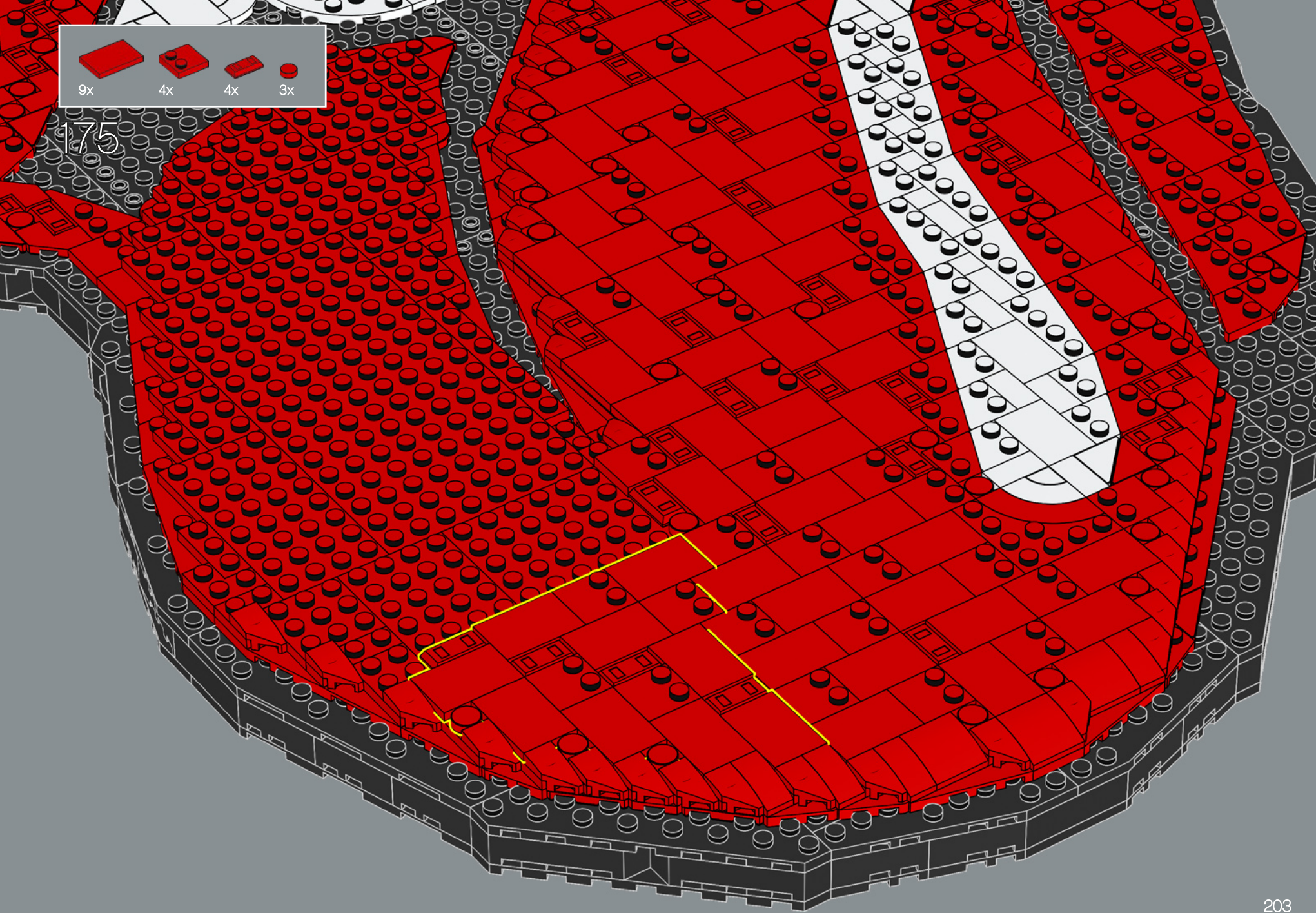

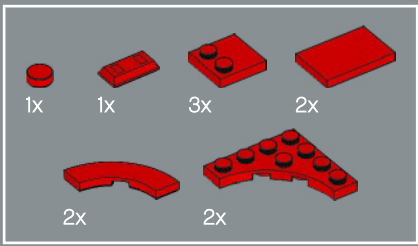

176

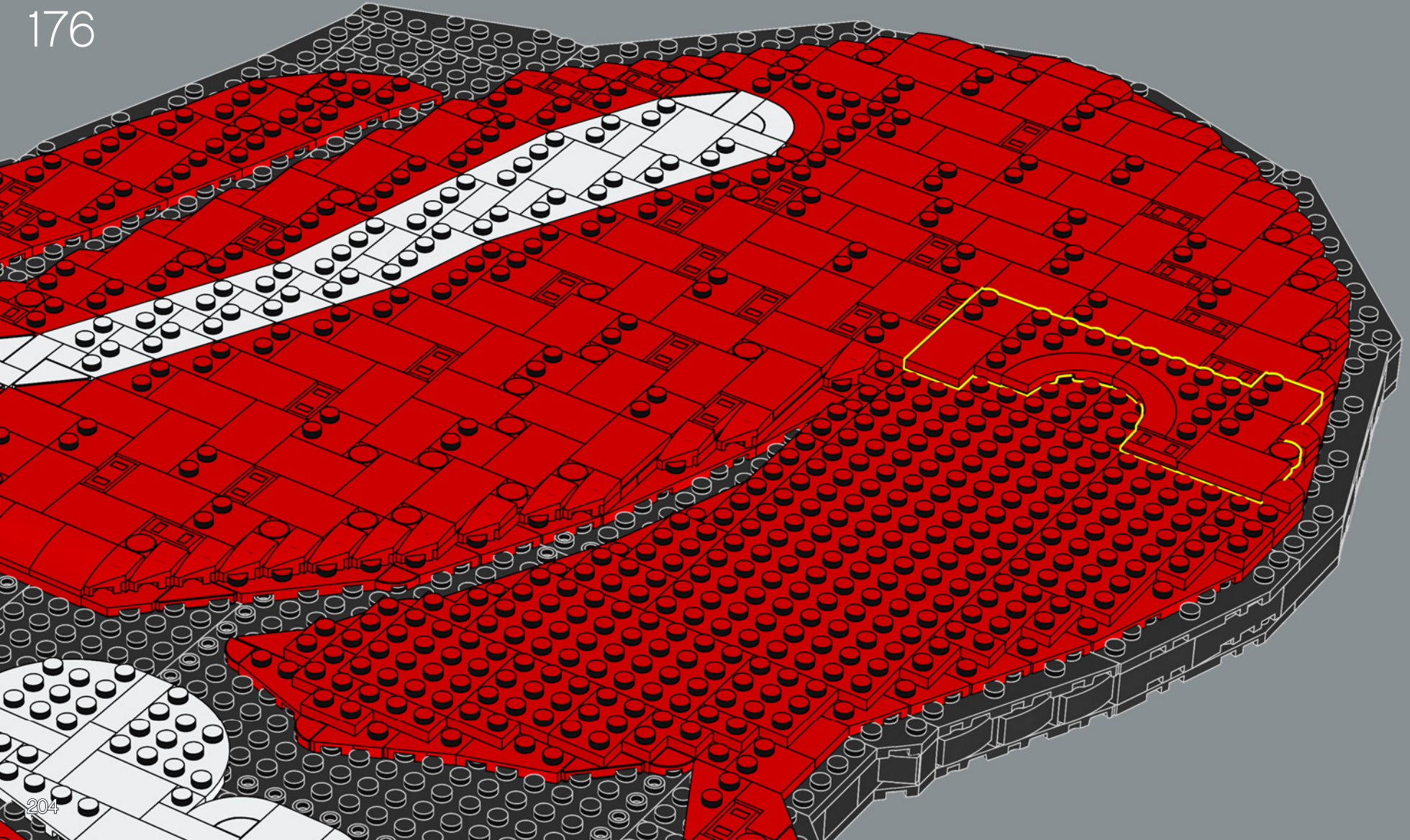



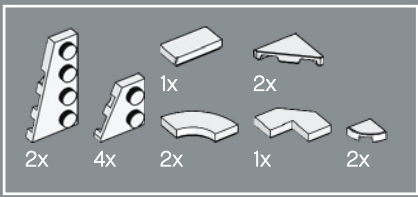

177

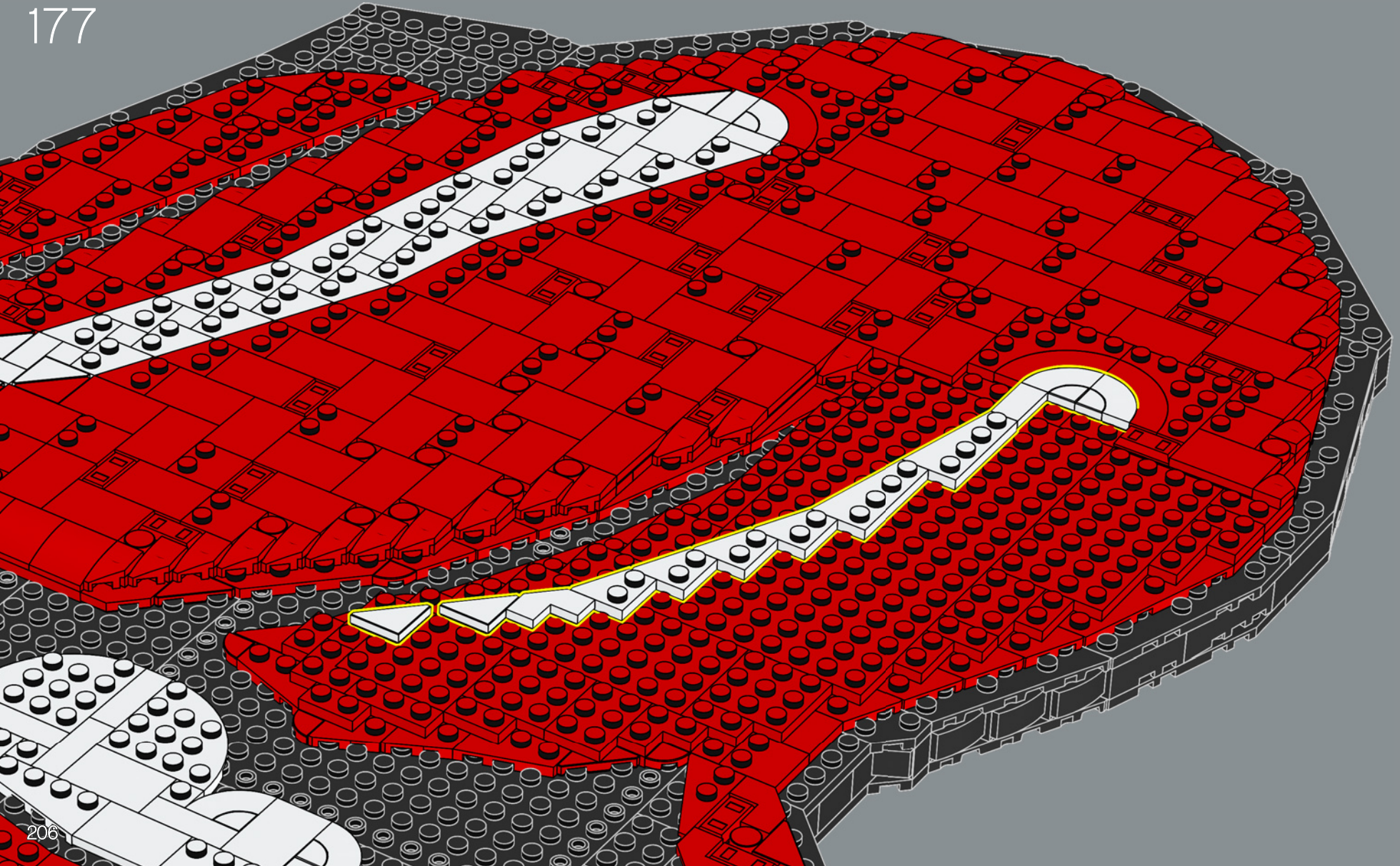

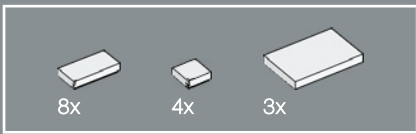

178

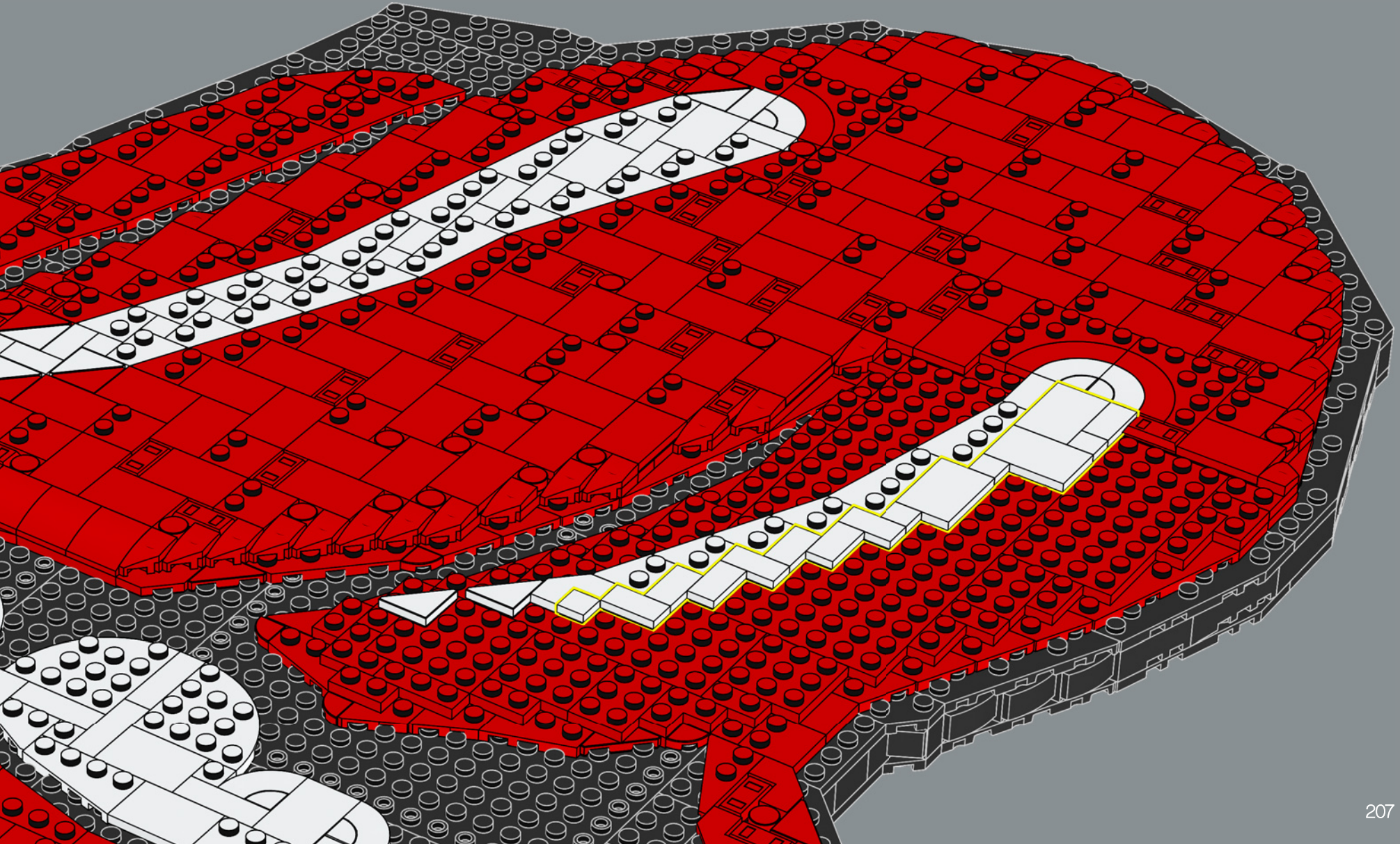

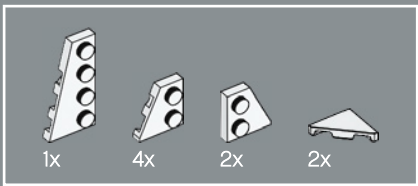

179

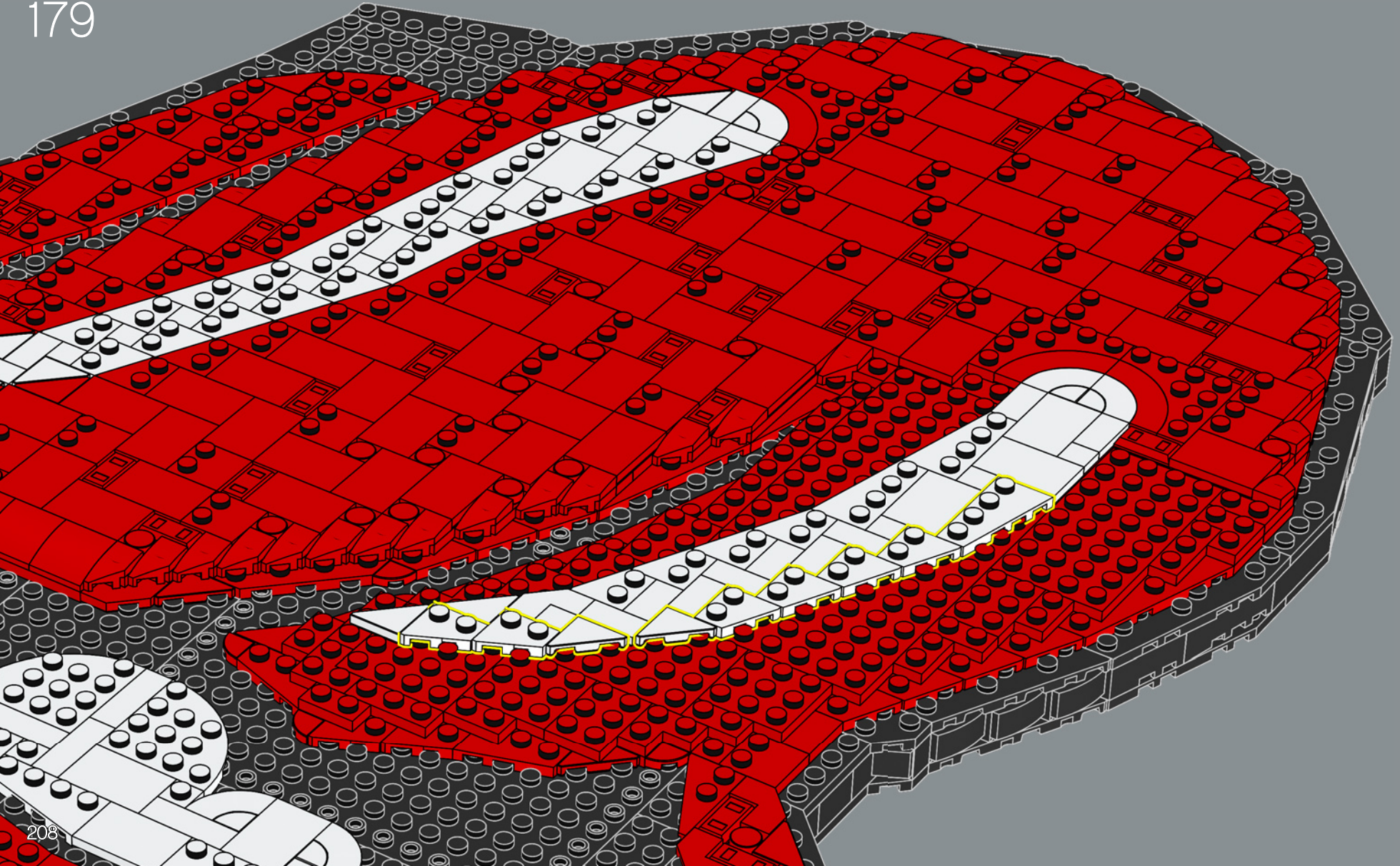

208



180

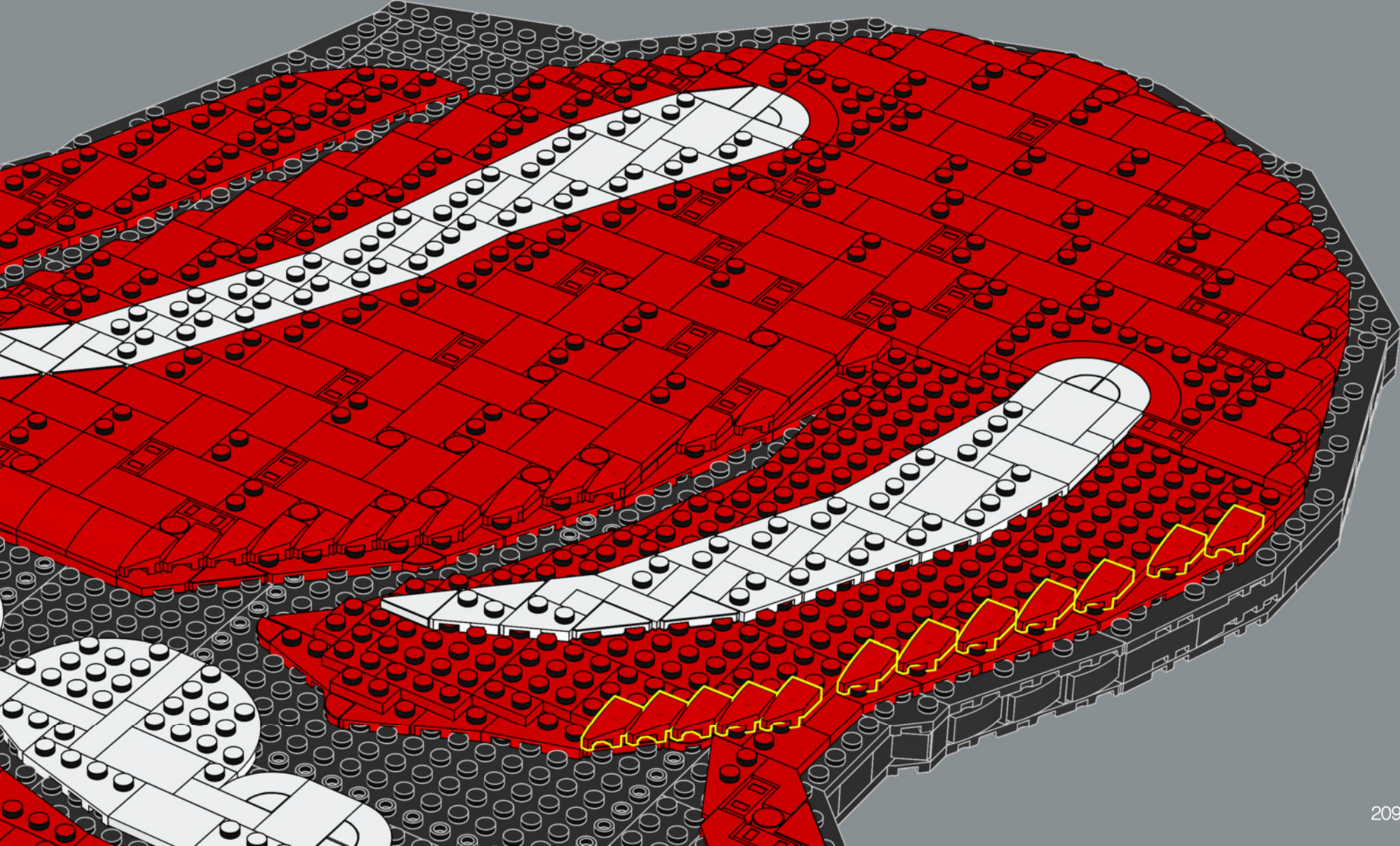



181

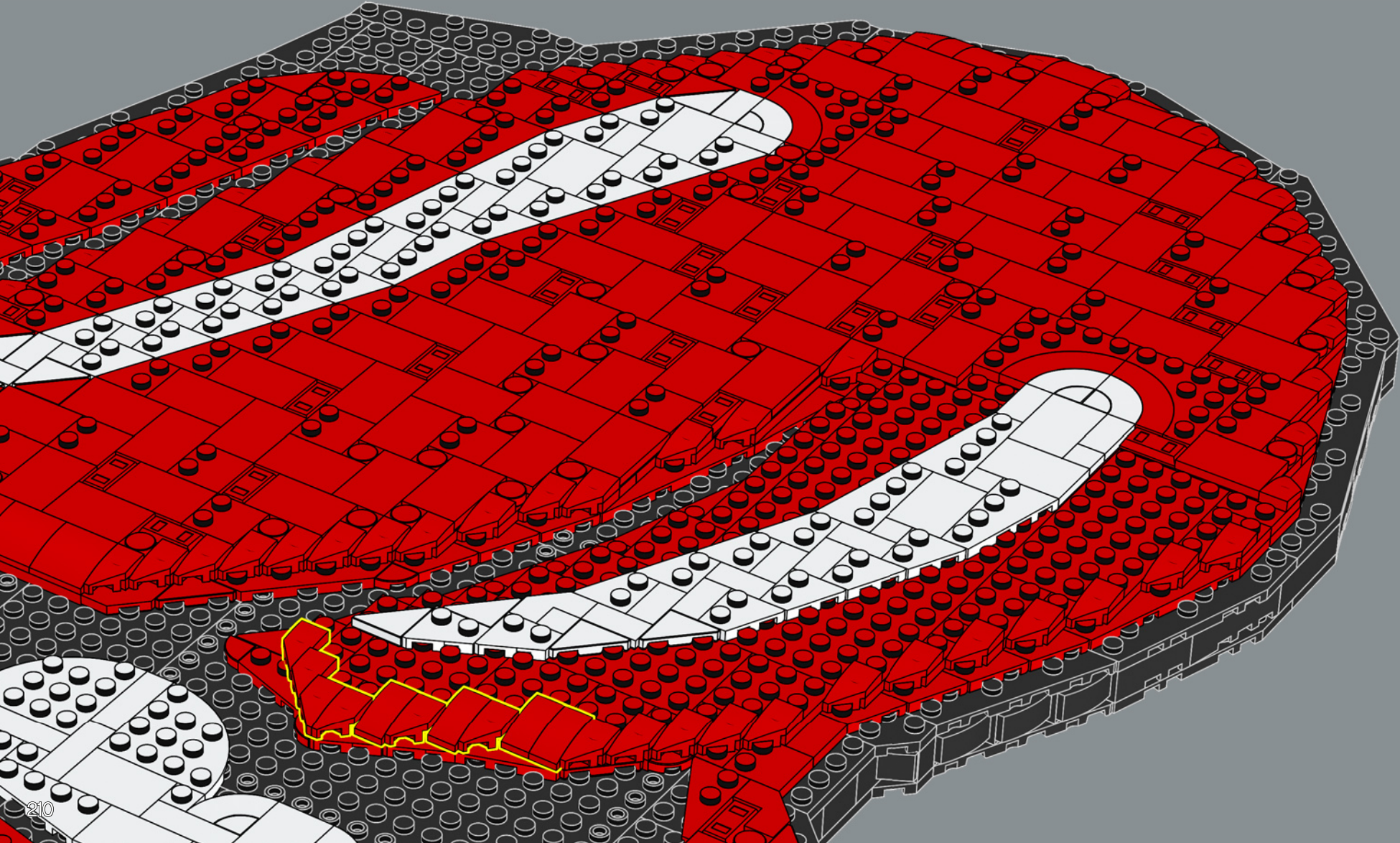

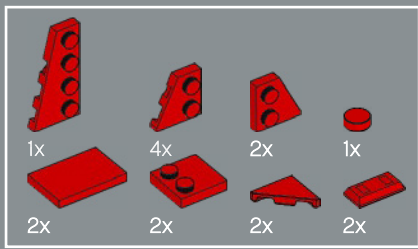

182

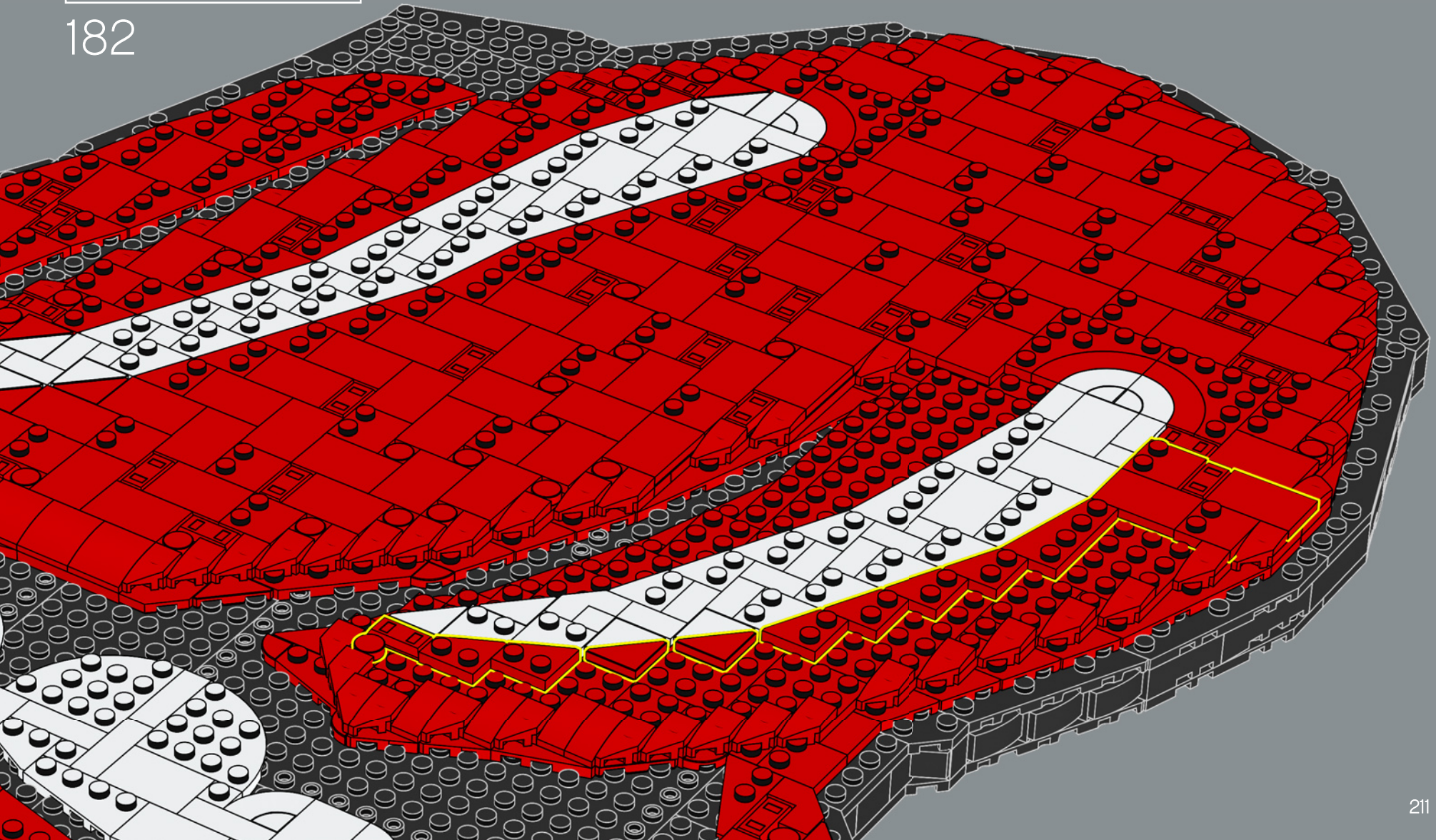

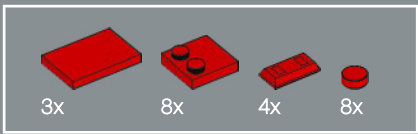

183

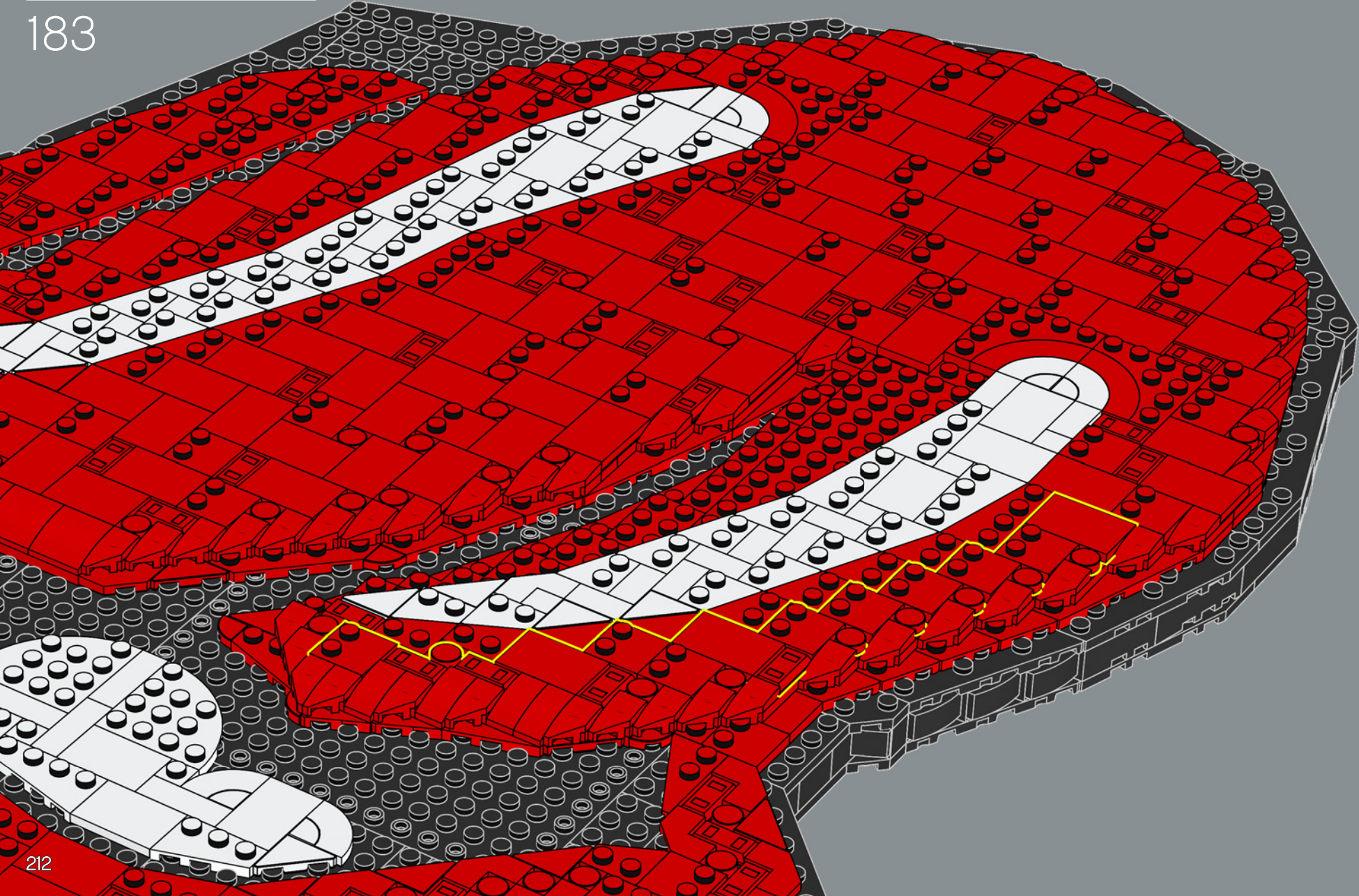

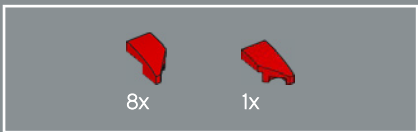

184

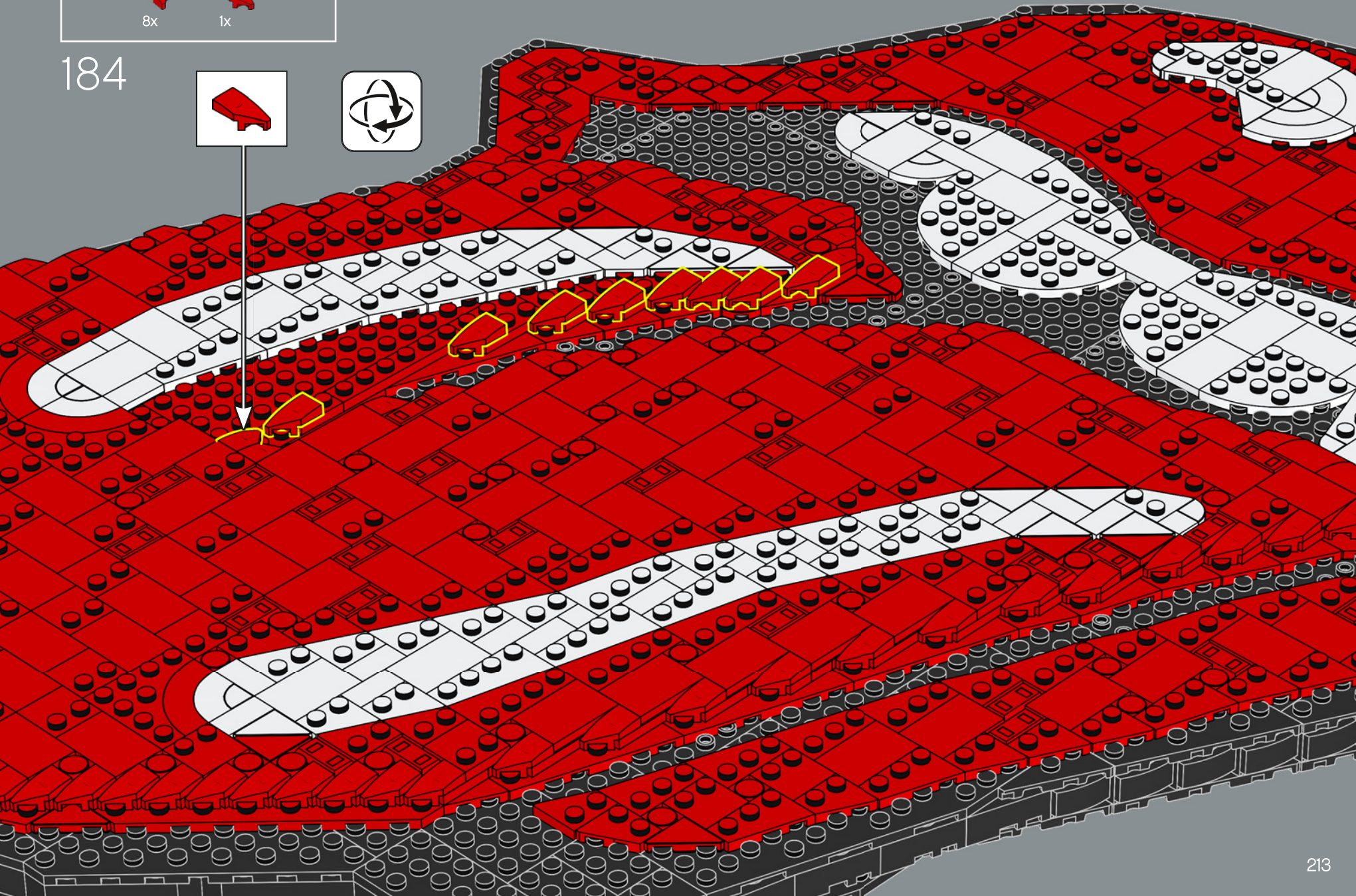

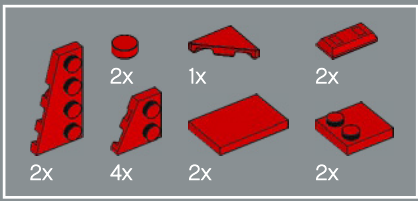

185

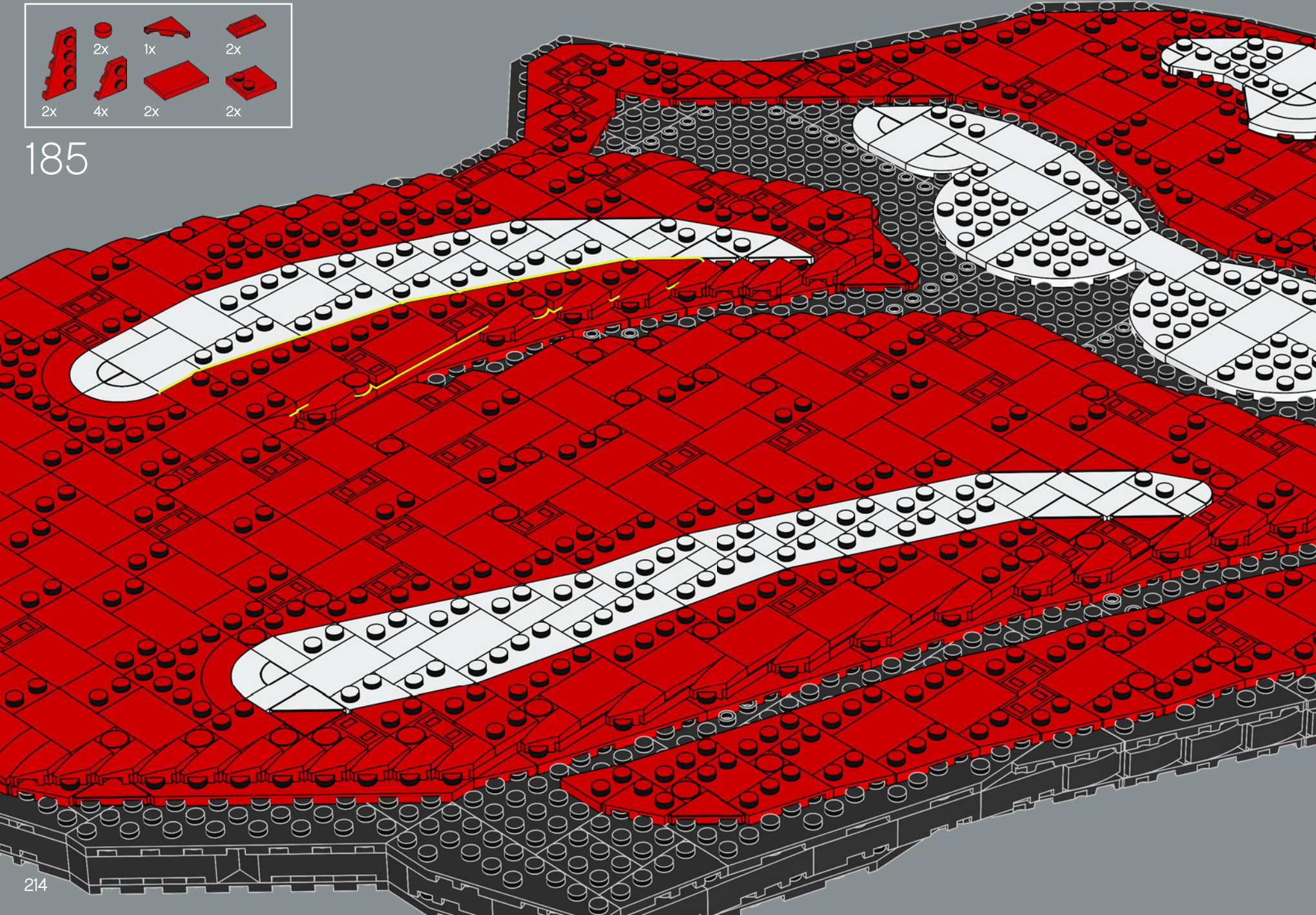



186

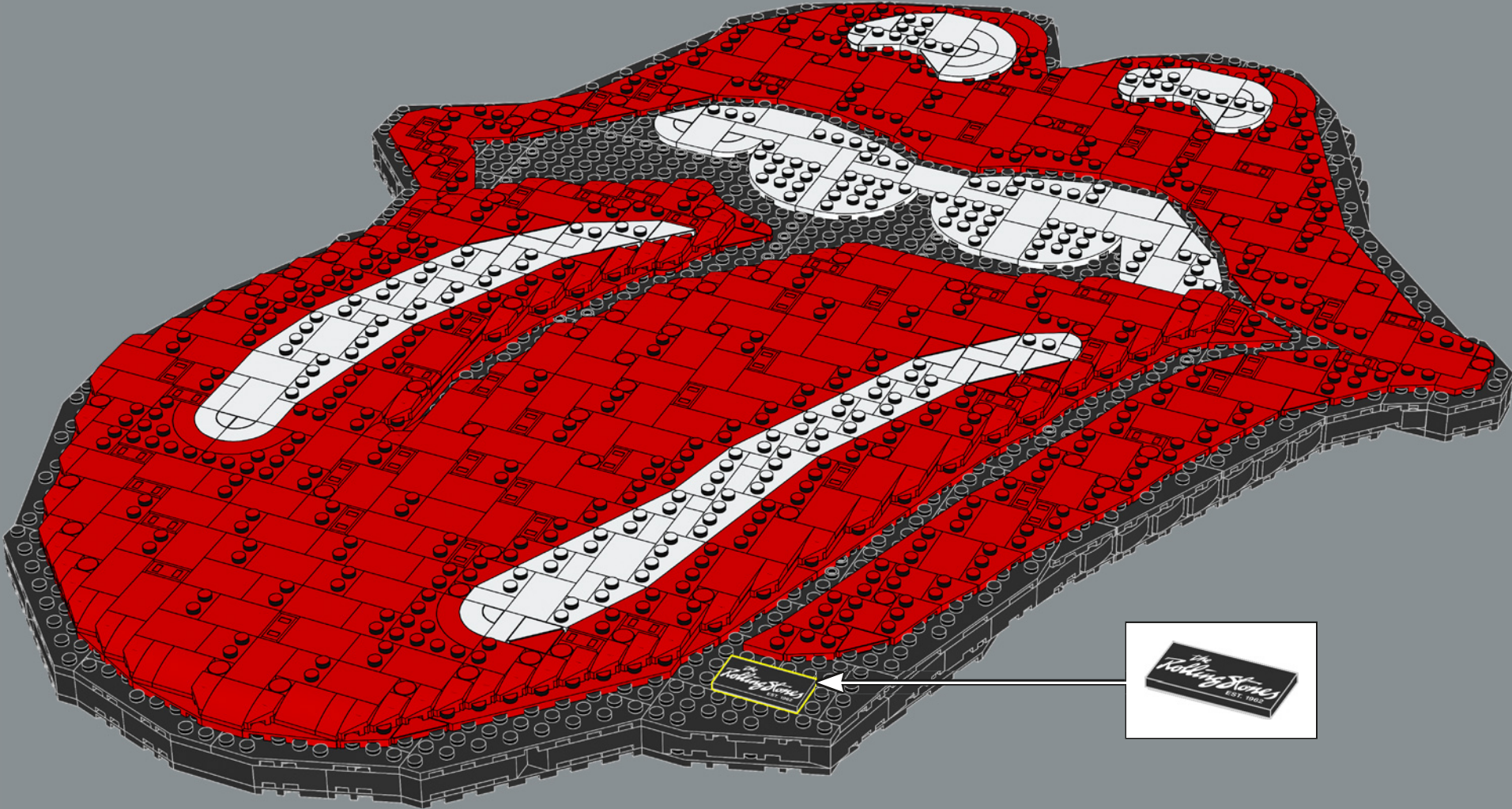





FEEDBACK AND WIN



FEEDBACK AND WIN

Your feedback will help shape the future development of this product series.

Please visit:

FEEDBACK UND GEWINNEN

Dein Feedback trägt zur Weiterentwicklung dieser Produktreihe bei.

Geh auf:

COMMENTEZ ET GAGNEZ

Vos commentaires nous aideront à concevoir les futurs produits de cette gamme.

Rendez-vous sur :

COMENTA Y GANA

Tu opinión nos ayudará a dar forma al desarrollo de esta serie de productos en el futuro.

Visita:

反馈有奖

您的反馈将有助于我们在今后改进本系列产品。

请访问：

[LEGO.com/productfeedback](https://www.lego.com/productfeedback)

By completing, you will automatically enter a drawing to win a LEGO® set.

Terms & Conditions apply.

Durch Ausfüllen nimmst du automatisch an der Verlosung eines LEGO® Preises teil.

Es gelten die Teilnahmebedingungen.

En envoyant vos commentaires, vous serez automatiquement inscrit(e) à un tirage au sort qui vous permettra de remporter un prix LEGO®.

Offre soumise à conditions.

Al contestar, participarás automáticamente en el sorteo y podrás ganar un set LEGO®.

Sujeto a Términos y Condiciones.

完成我们的反馈调查，即可自动进入抽奖环节，赢取乐高®套装。

适用《条款和条件》。

- 8x 302401
- 12x 307001
- 14x 6172366
- 25x 6132203
- 10x 6132204
- 2x 4179874
- 2x 6373439
- 8x 4161326
- 1x 4160857
- 5x 302301
- 19x 306901
- 15x 6217875
- 18x 6403936
- 1x 6168612
- 9x 6172674

- 6x 4558168
- 17x 6156667
- 13x 370101
- 4x 4178429
- 87x 6284574
- 55x 614121
- 65x 6177505
- 9x 6170390
- 31x 6141553
- 77x 6141552
- 4x 6286513
- 1x 6286516
- 3x 6371578
- 19x 4180533

- 17x 6177507
- 5x 6375825
- 7x 4180504
- 14x 4161329
- 4x 4160866
- 60x 6394880
- 8x 6029946
- 18x 6393320
- 44x 302321
- 29x 6351892
- 1x 6059013
- 5x 6170834

- 1x 6059021
- 74x 6219819
- 10x 6105976
- 2x 6310198
- 15x 242021
- 14x 6217194
- 14x 362321
- 10x 302121
- 116x 6189130
- 3x 371021
- 4x 6217123
- 1x 245021
- 3x 366621
- 7x 4243814

- 3x 6394888
- 1x 6278445
- 3x 379521
- 8x 370221
- 2x 303421
- 4x 303521
- 1x 6394884
- 3x 4514717
- 1x 428221
- 5x 6019675

- 23x 614126
- 22x 302426
- 1x 6141556
- 2x 6295295
- 6x 6295293
- 2x 4180536
- 2x 4180508
- 1x 4161332
- 122x 6279875
- 4x 3200026
- 22x 6047276
- 19x 6138173
- 3x 6174243
- 2x 4584274



5x
4251393



3x
4251394



1x
302226



5x
6365577



1x
235726



10x
4526931



4x
362326



5x
6258209



10x
6258214



4x
6394879



4x
4504382



3x
4558954



1x
407026



6x
4527766



17x
302126



3x
371026



1x
6078886



19x
6174917



6x
4227684



1x
6323891



3x
6078889



3x
300126



10x
6039347



3x
6350415

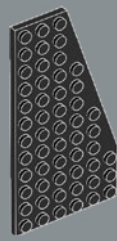

2x
6394881

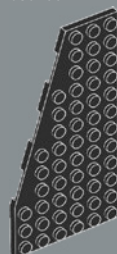

2x
4143180



2x
241926



4x
4243819



5x
4160025

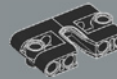

2x
6302094



5x
379526



1x
6318582



3x
346026

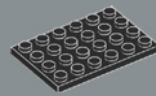

1x
303226



6x
303426



2x
4106977



5x
303526



9x
303626



5x
4205347



1x
302926

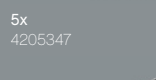

5x
6302092



130x
4157103



67x
6314247



70x
6331261



3x
4211483



8x
4211640



17x
4211848



69x
6319958



5x
6185546



7x
6299413



2x
242023



3x
4558606



5x
4243815



36x
379523



96x
614124



3x
389424

Customer Service
Kundenservice
Service Client
Assistenza clienti
Atención al cliente
Serviço de Apoio ao Consumidor
Ügyfélszolgálat
Klientu apkalpošanas dienests
Serviciul pentru clienți
客户服务
コンシューマーサービス
고객 서비스
LEGO.com/service

the
Rolling Stones
EST. 1962