



3182



WARNING: CHOKING HAZARD.
Toy contains small parts and a small ball.
Not for children under 3 years.



2

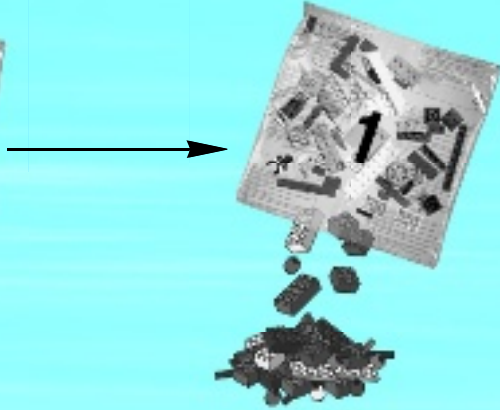
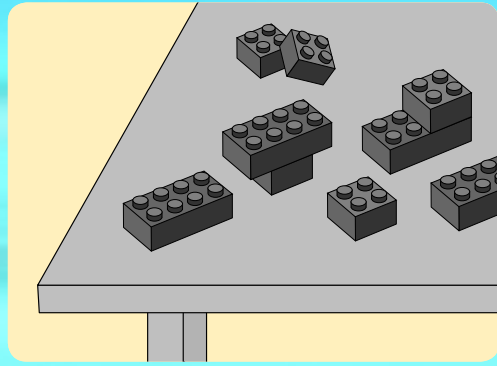
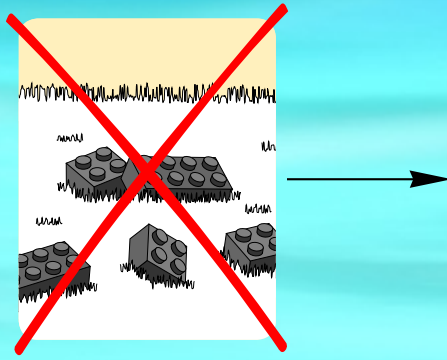

AVERTISSEMENT : RISQUE D'ÉTOUFFEMENT.
Le jouet contient des petites pièces ainsi qu'une petite boule.
Il ne convient pas aux enfants de moins de 3 ans.



ADVERTENCIA: PELIGRO DE ASFIXIA.
Juguete que contiene partes pequeñas y una pelota pequeña.
No recomendado para niños menores de 3 años.

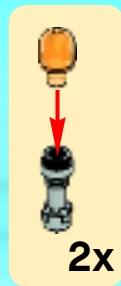
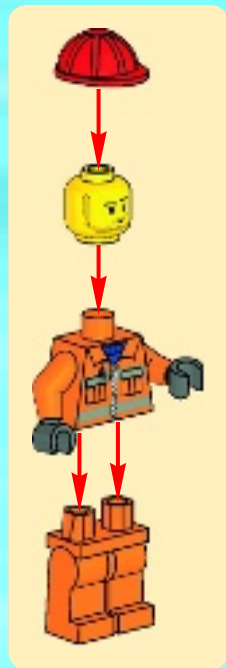
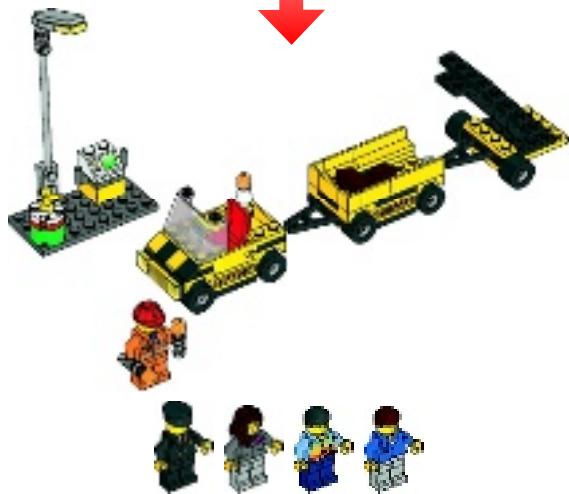





1



2



3

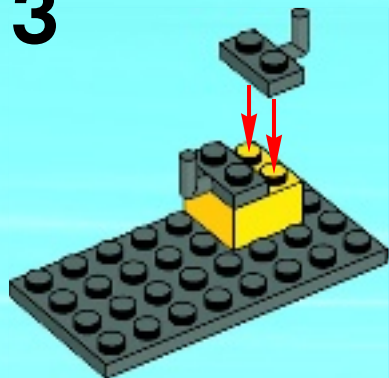

4

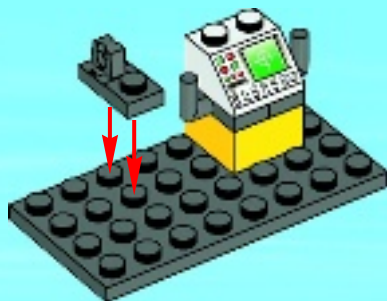

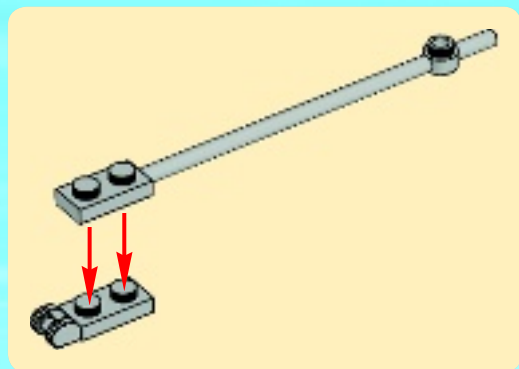

5

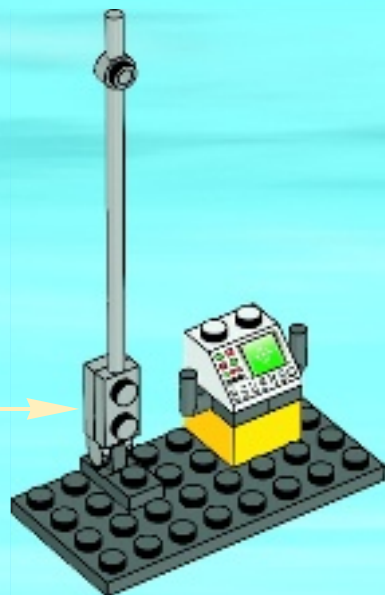

1

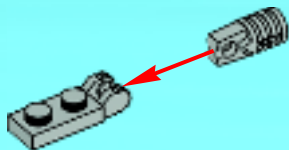

2

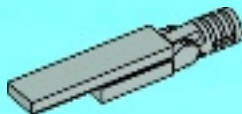

3

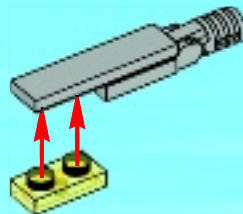

4



1



2



3



4



7

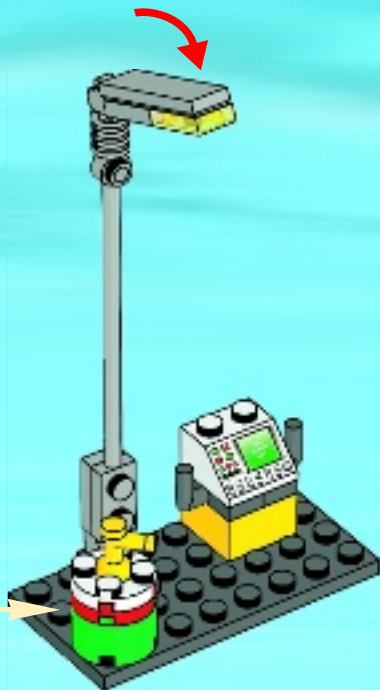



1



2



3

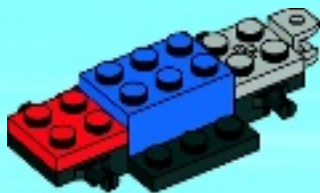

4

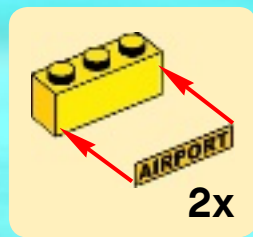

5



6



7



8

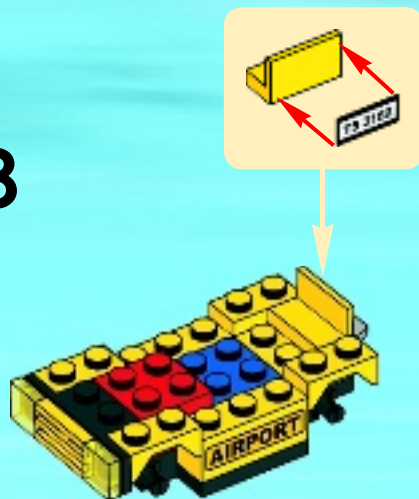

9



10



11



12

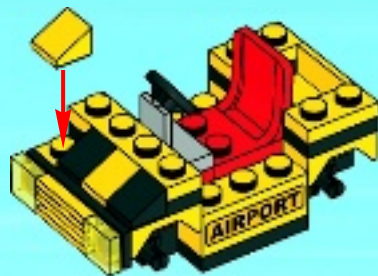

13



14

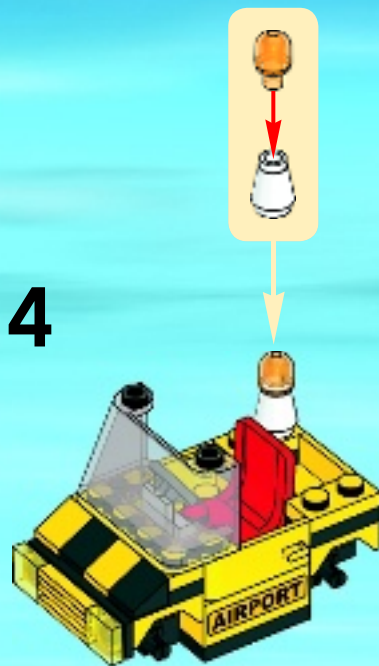





1



2



3



4

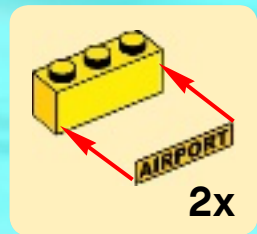

5



6



7



8



9



10

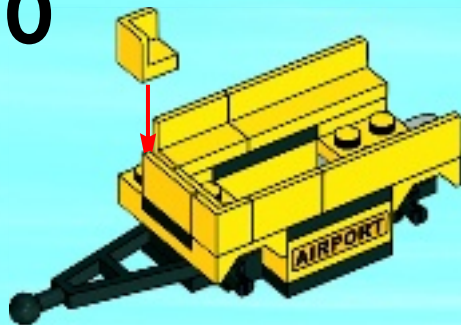

11





1

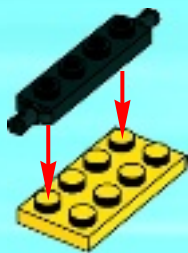

2



3

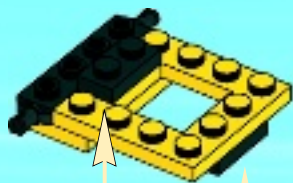

4

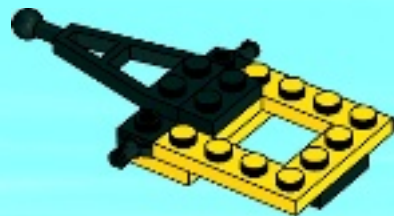

5

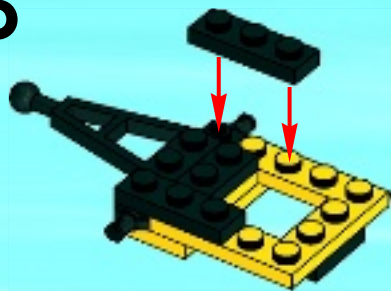

6

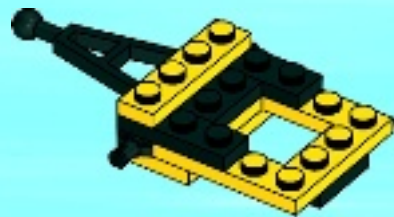

7



8





LEGO

CITY



3177



3178



3179



3180



3181



3182

LEGO CITY



4209



4208



4427



www.LEGOclub.com



LEGO® Club Email



LEGO® Club Magazine



www.LEGO.com

SIGN UP ONLINE!

www.LEGOclub.com



00800 5346 5555*



1-866-534-6258 • 1-877-518-5346

US & Canada only

Canada seulement

- * Freephone. Mobile charges may apply.
- * Numéro sans frais. Des frais peuvent s'appliquer avec les téléphones cellulaires.
- * Gebührenfrei. Kosten für Anrufe aus Mobilfunknetzen können abweichen.
- * Gratis telefonnummer vanaf vaste lijn.
- * Det er et gratis nummer, når du ringer fra fasttelefon.
- * Det är gratis, när du ringer från en fast telefon.
- * Numéro sans frais. Des frais peuvent s'appliquer avec les téléphones portables.